



**Gateway Cities
Traffic Signal Synchronization and
Bus Speed Improvement Project
I-5/Telegraph Road Corridor**

Consultant's Briefing Meeting

Siemens Energy & Automation, Inc.

Gardner Transportation Systems

November 12, 2002

I-105/I-5 Telegraph Road Project Physical Components

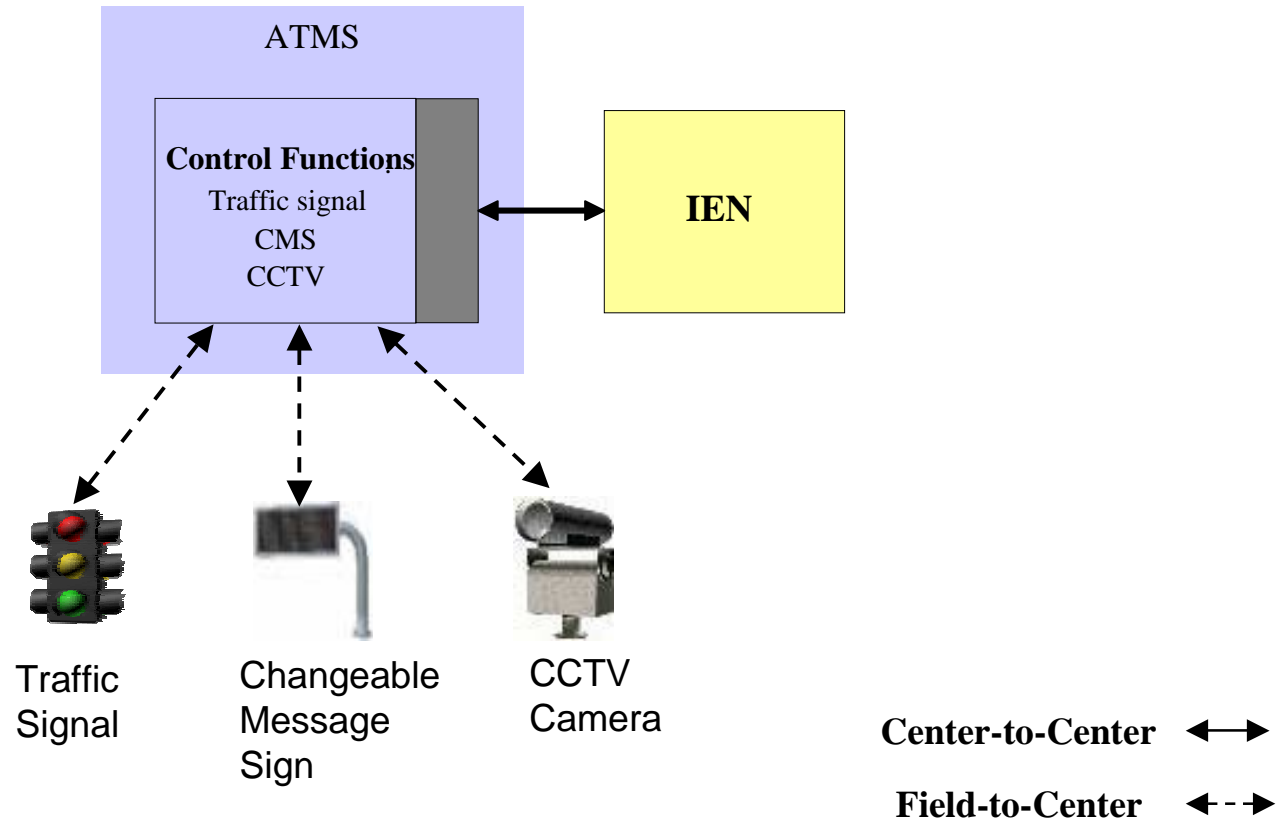



I-105 Proposed System Architecture

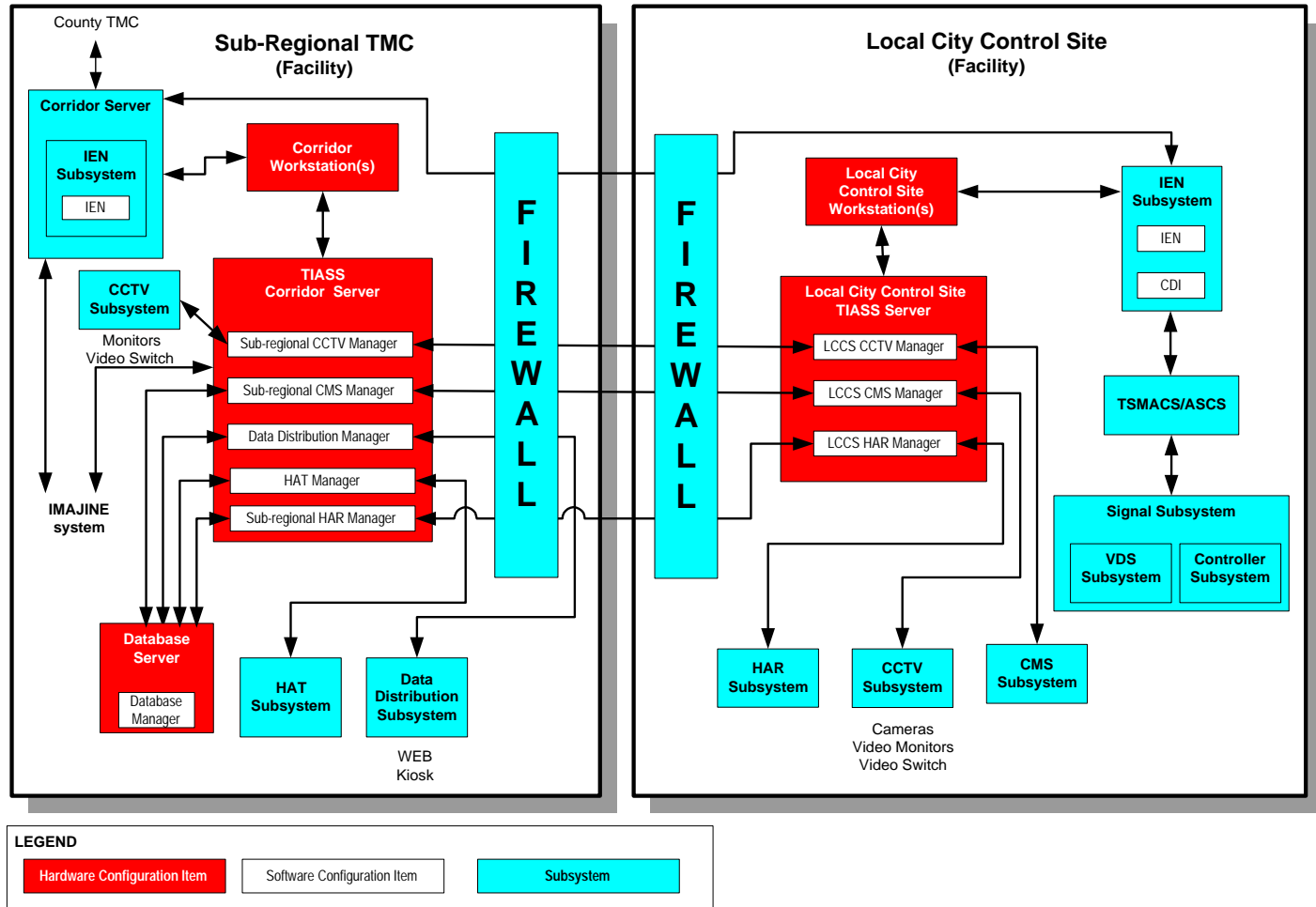

I-5/Telegraph Road Revised System Architecture

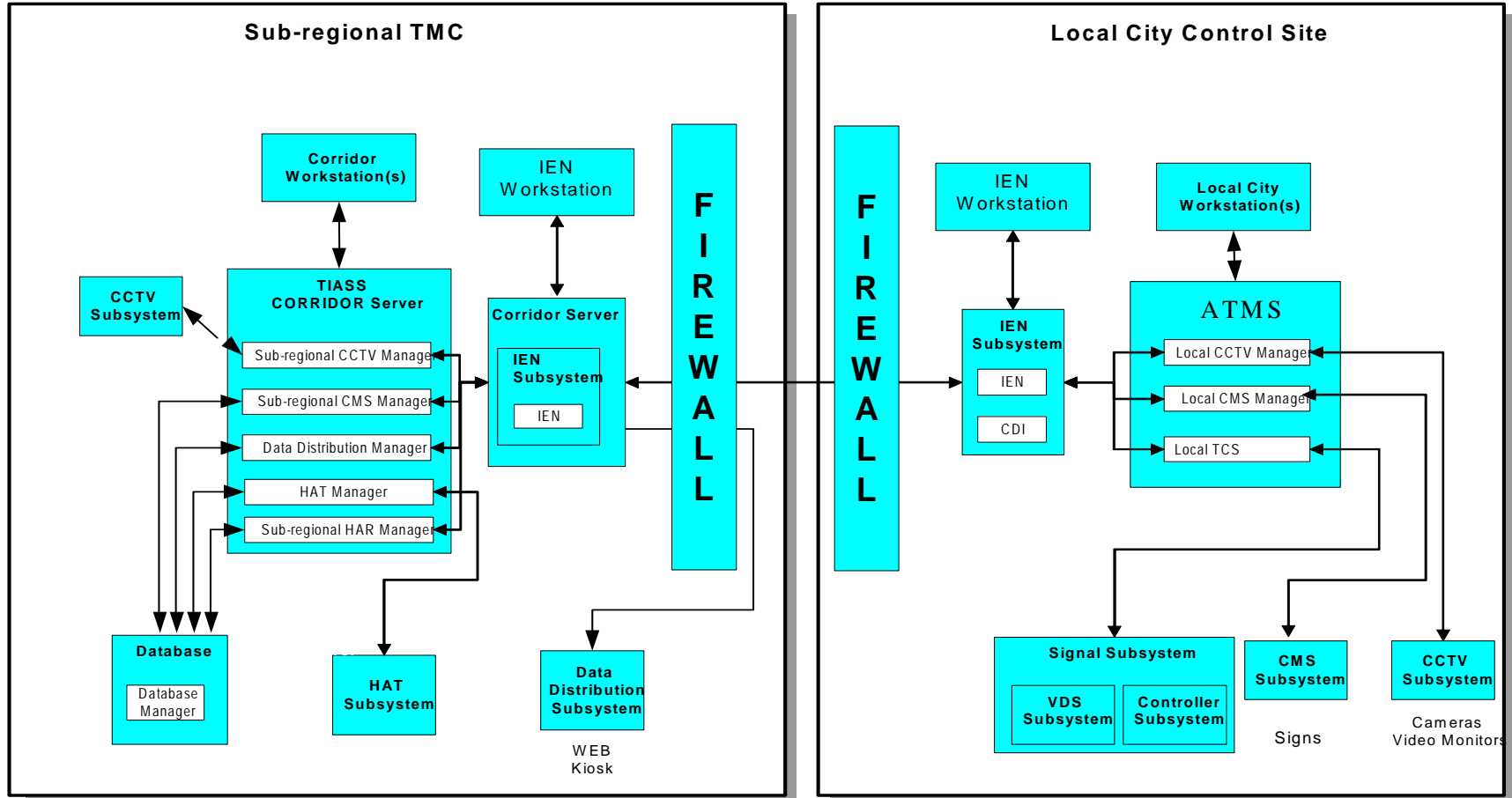



Allocation Of Functionality

| | Traffic Control | CCTV Viewing Only | CCTV | CMS |
|------------------|-----------------|-------------------|------|-----|
| Commerce | X | | X | |
| Downy | X | | X | |
| La Mirada | X | X | | |
| Montebello | X | X | | |
| Pico Rivera | X | X | | |
| Santa Fe Springs | X | | X | X |
| LA County DPW | X | | X | |
| Caltrans D7 | X | | X | |

Local City Control Site (Typical)

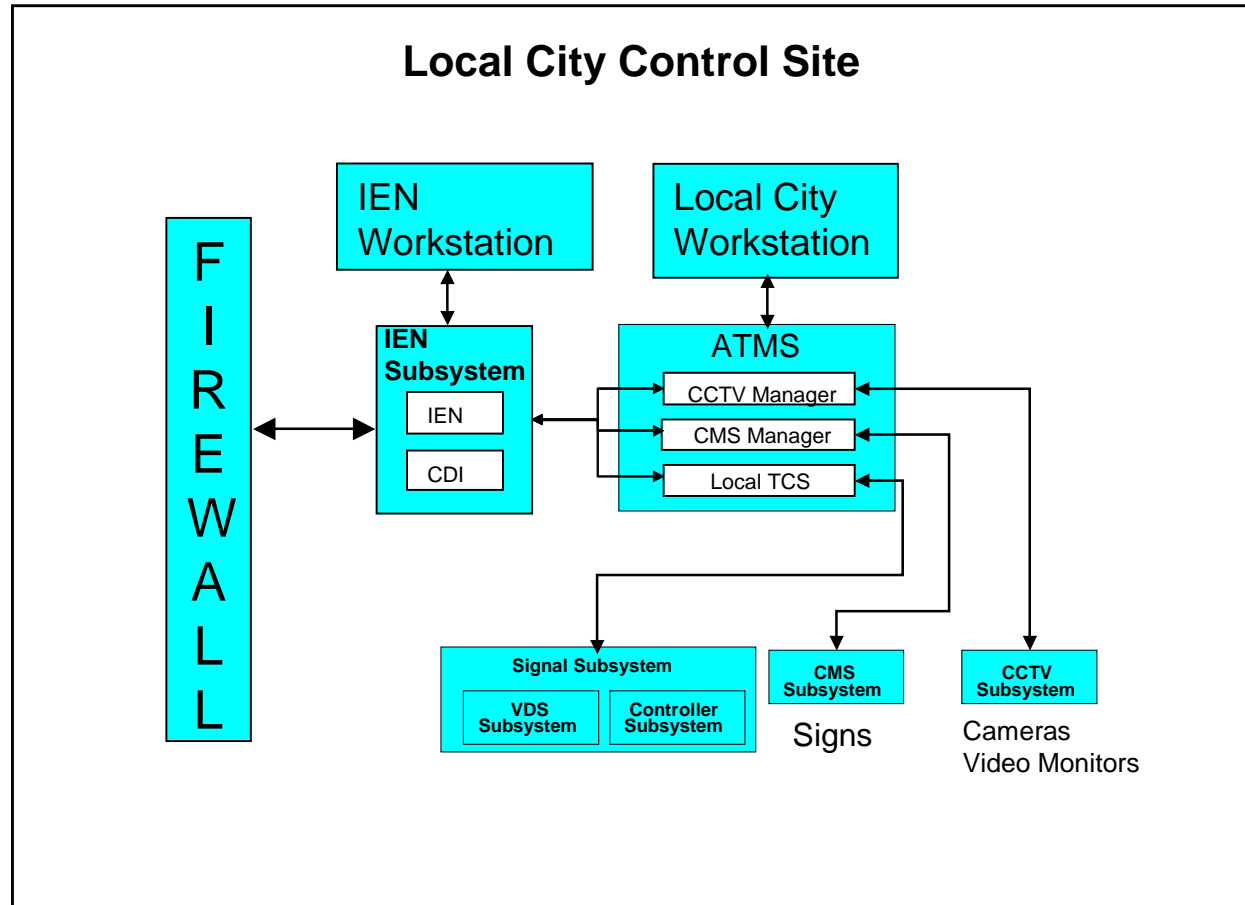

I-5/Telegraph Road Proposed Corridor Architecture Stand Alone LCCs

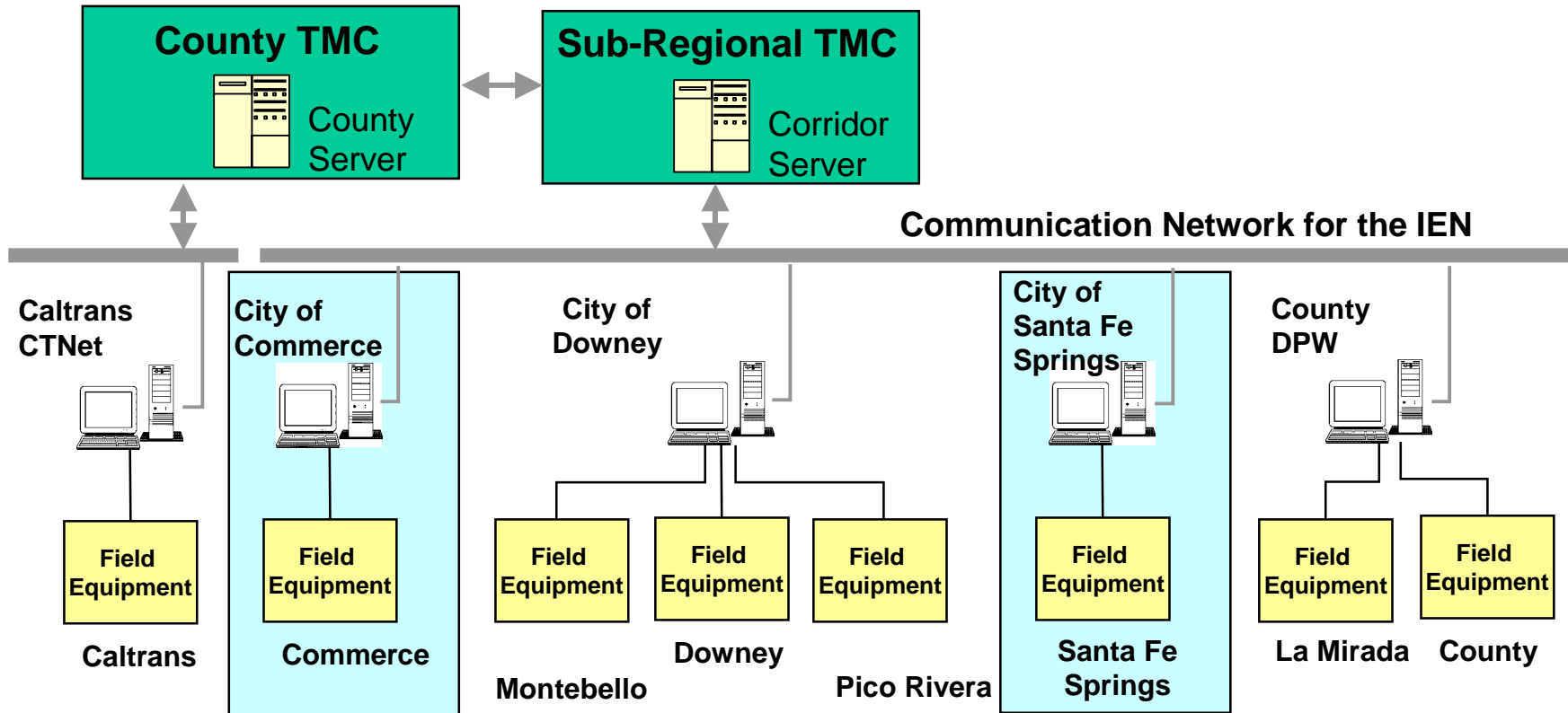

Stand Alone LCC Physical Architecture

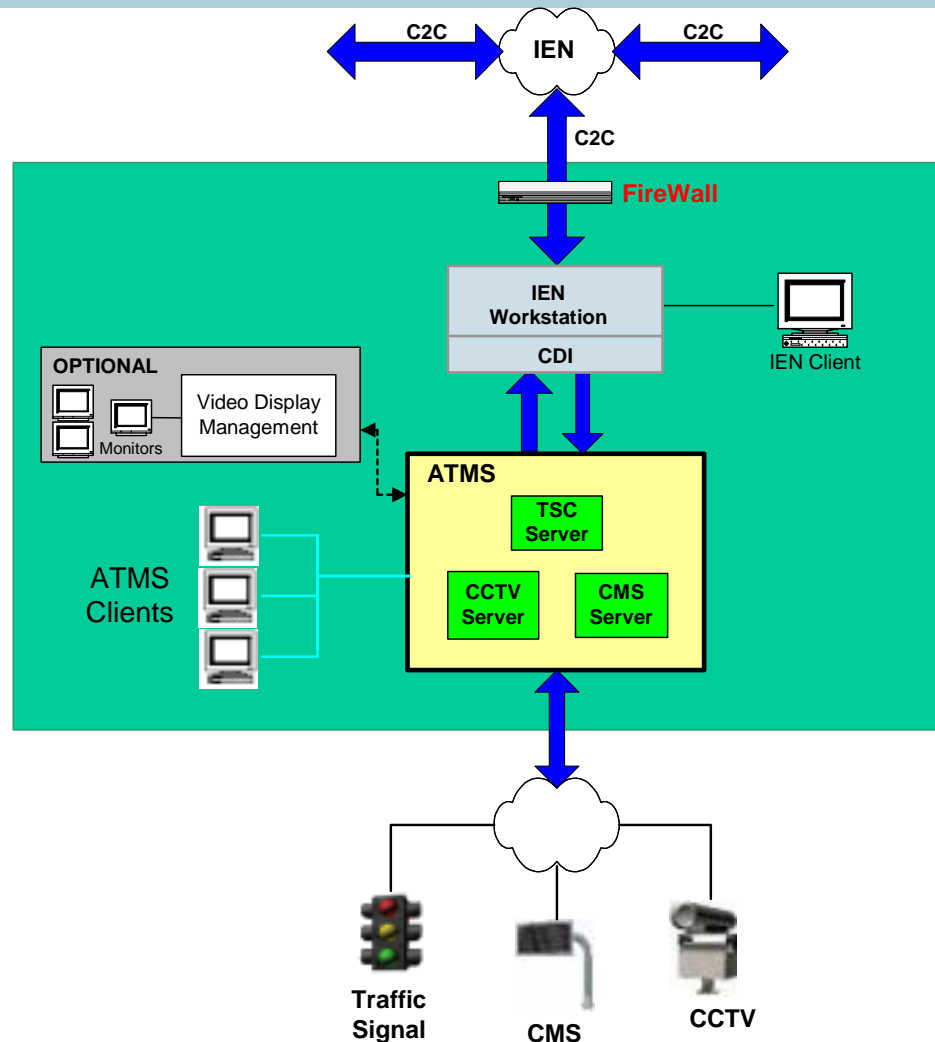

Stand Alone LCC System Configuration

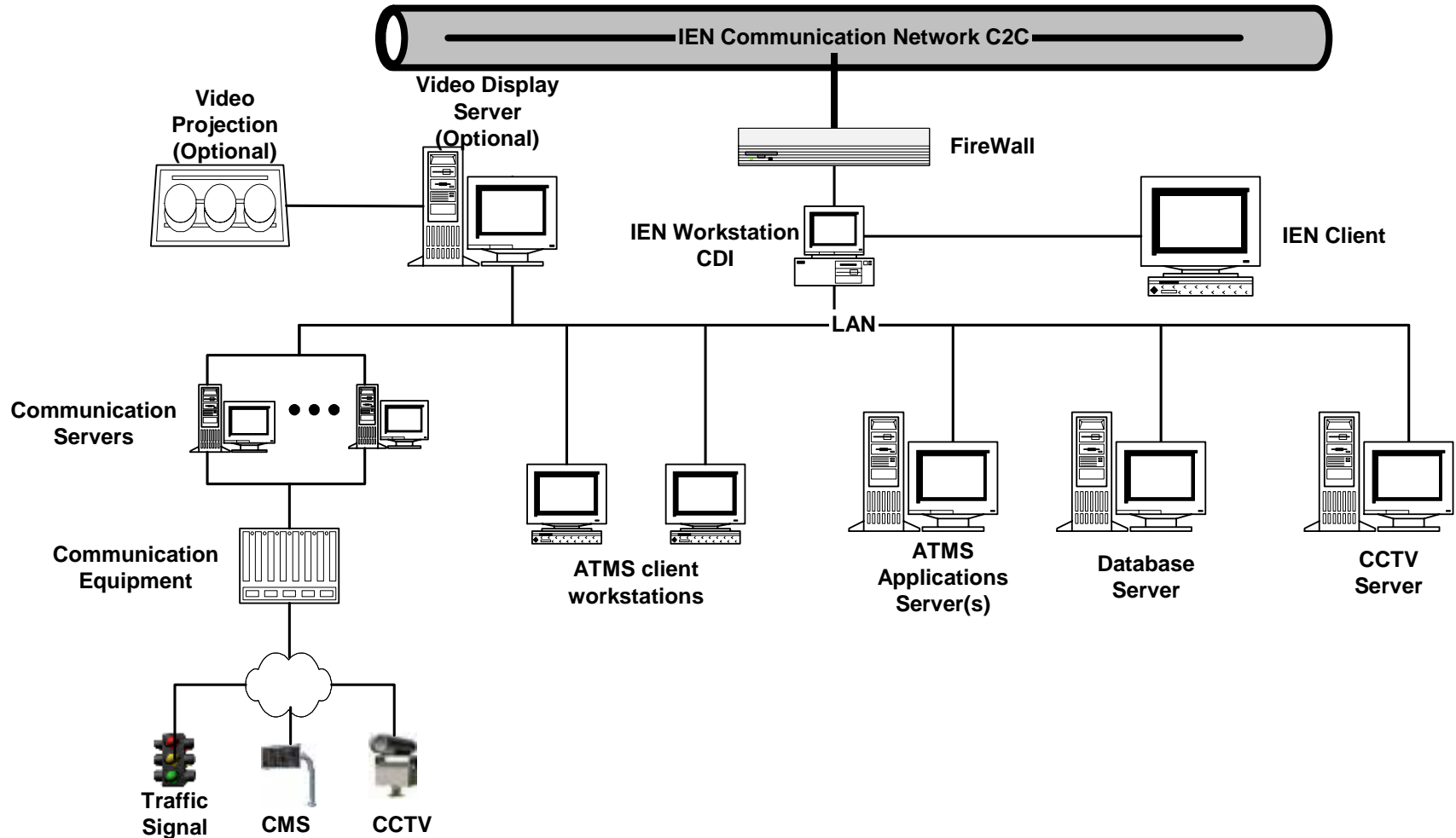

I-5/Telegraph Road Proposed Corridor Architecture

LCC with Hosting

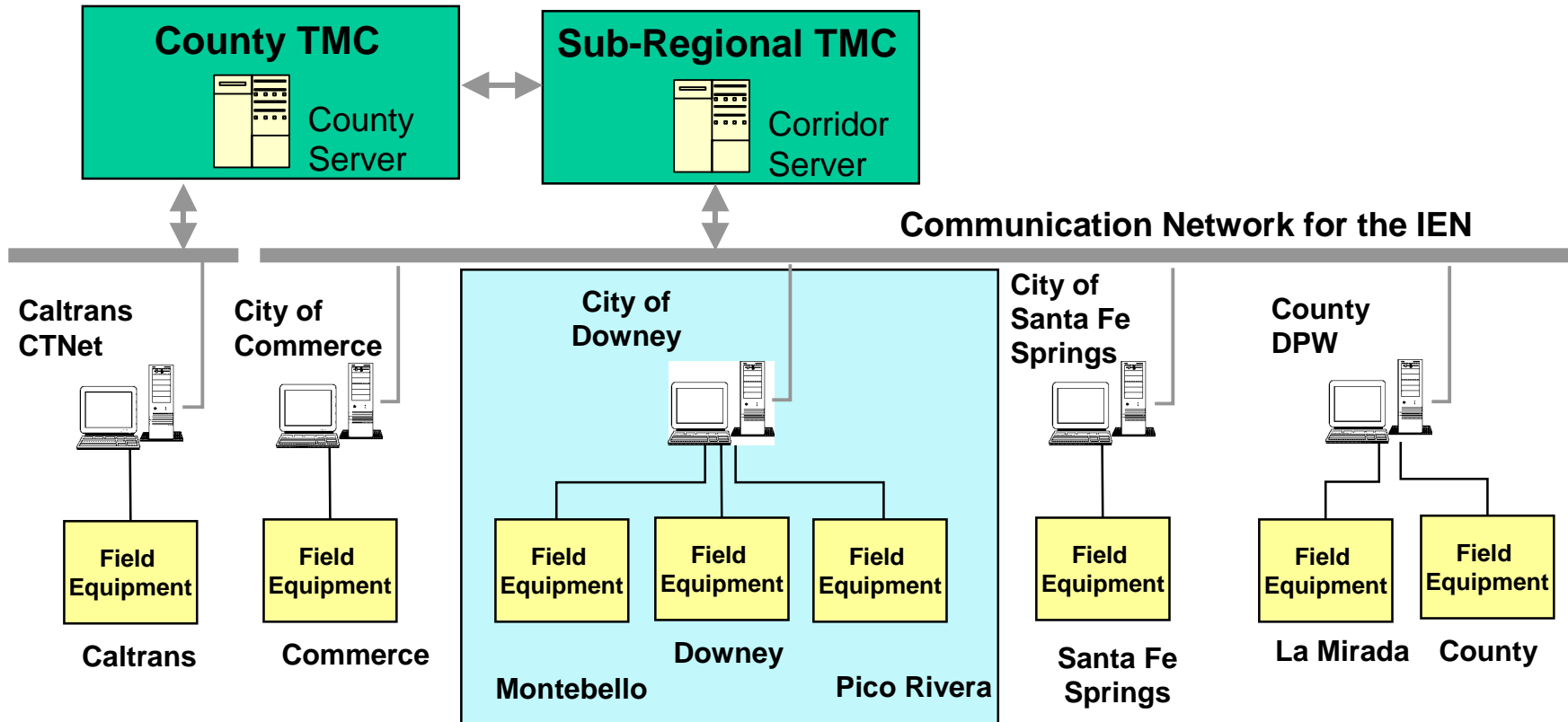

LCC with Hosting Physical Architecture

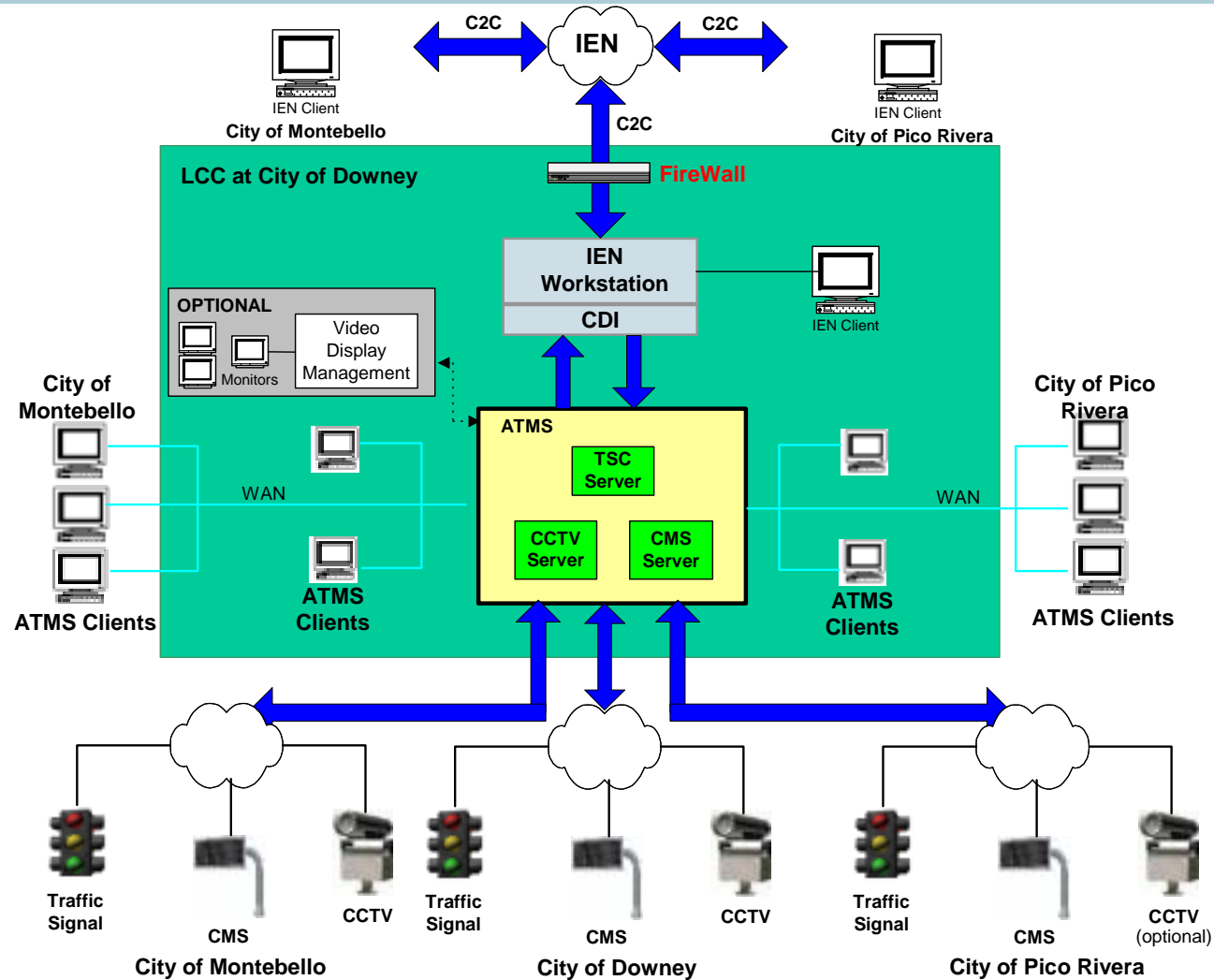

LCC with Hosting System Configuration

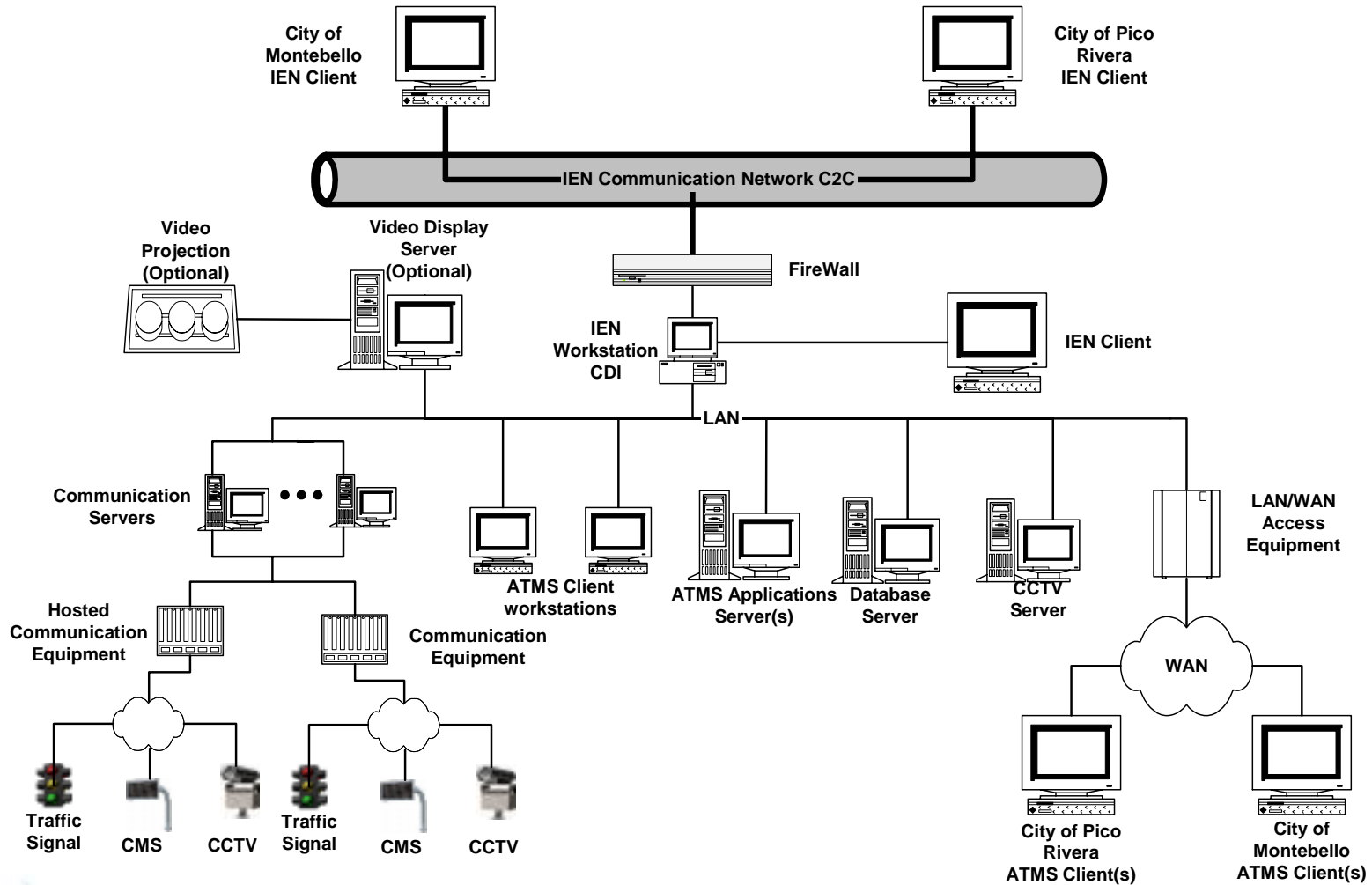

I-5/Telegraph Road Proposed Corridor Architecture Client Only

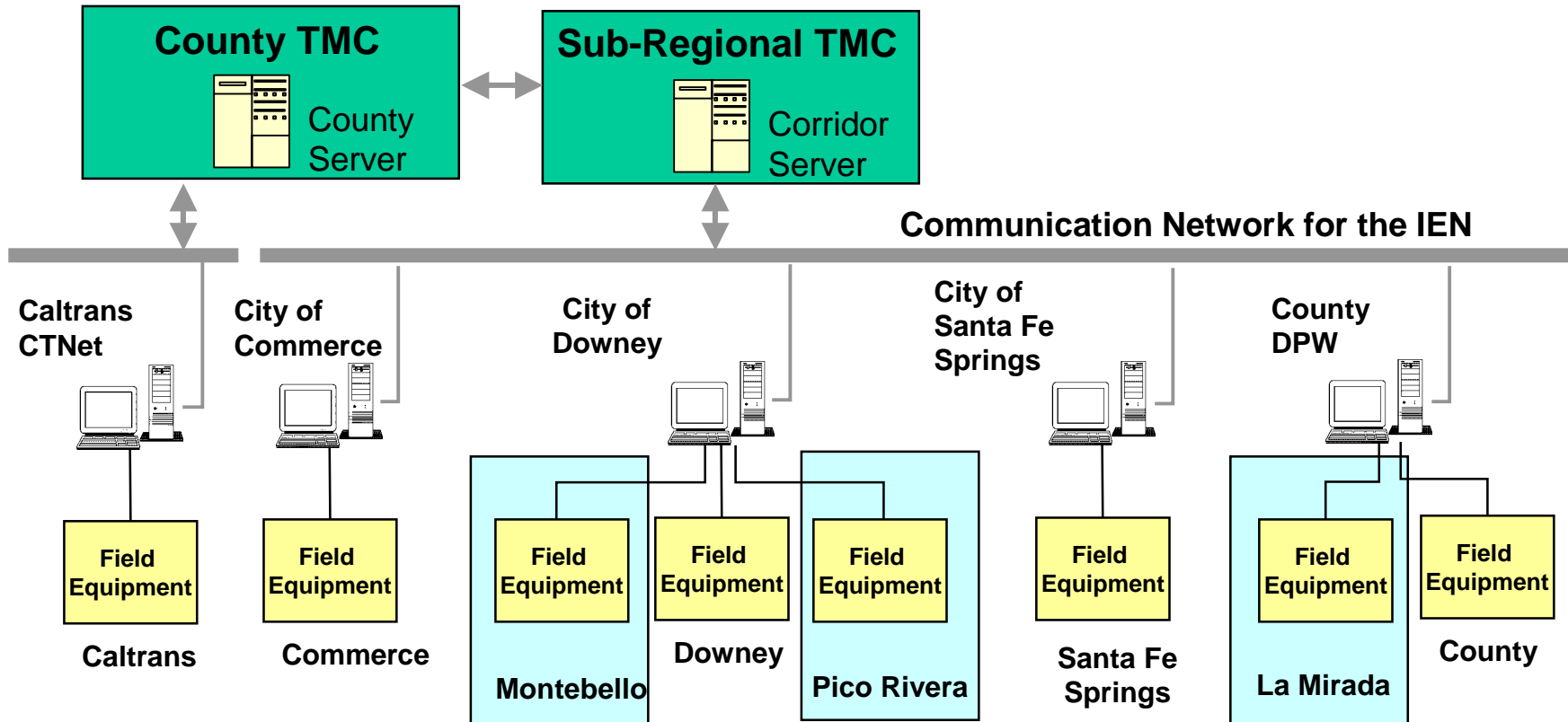

Client Only LCC System Configuration

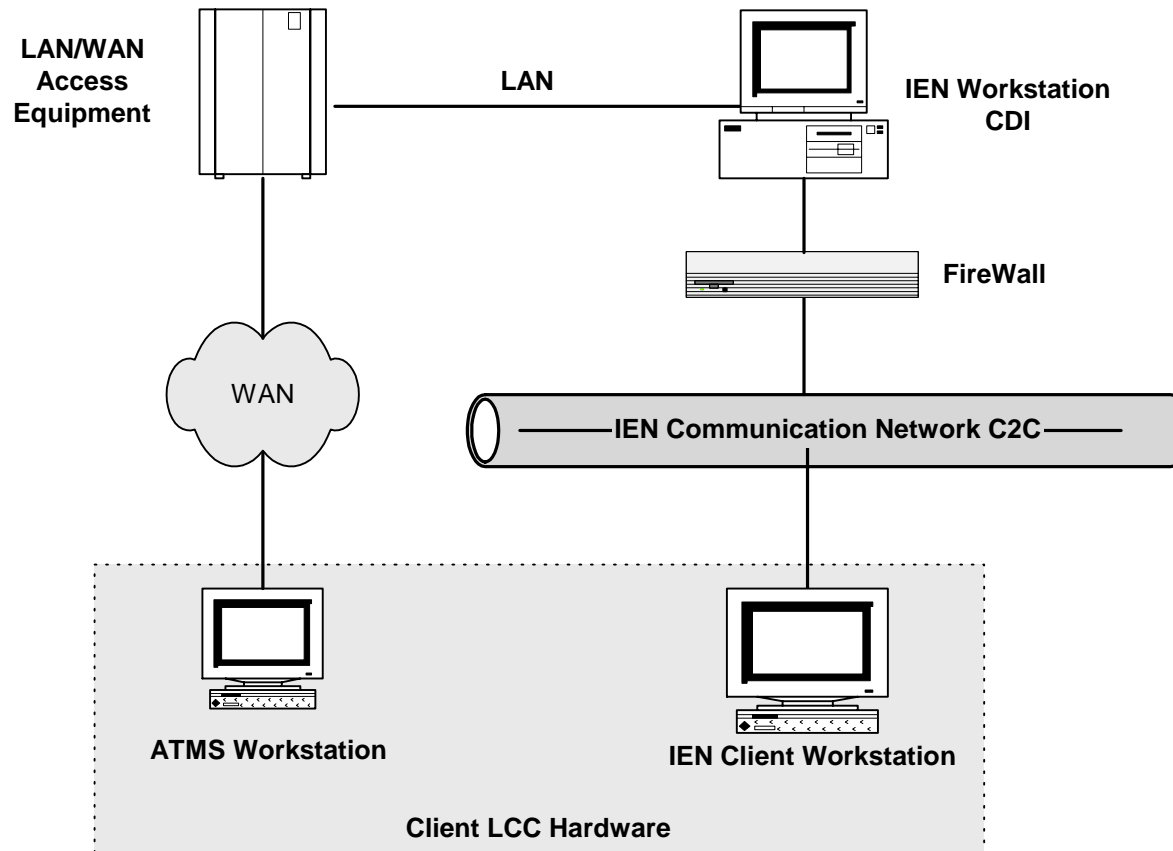

LCC Recommendations

Summary of Meeting Minutes



- All cities, except City of Pico Rivera, were able to identify the potential location of their LCC.
- The City of Pico Rivera stated that they may be able to allocate space in the City Hall or City Yard in the future but did not want to commit to a location just yet.
- Cities do not have resources to staff the LCC's for a long period of time during the day.
- Most cities will monitor the system on an exception basis, in response to an alarm from the system or during a traffic emergency situation.
- All cities identified a place for the LCC site within existing buildings. The buildings have existing air conditioning and service. It is anticipated that in most cases no upgrade to these in-place systems will be needed.
- All Cities except Downey identified a place for LCC site within an existing office/laboratory. The cities did not express a need to secure the LCC site beyond the security provided for these buildings.
- Most cities identified at least two locations for ATMS workstations – the City Hall and City Yard.

GIS Database Tool

Absia's Building One

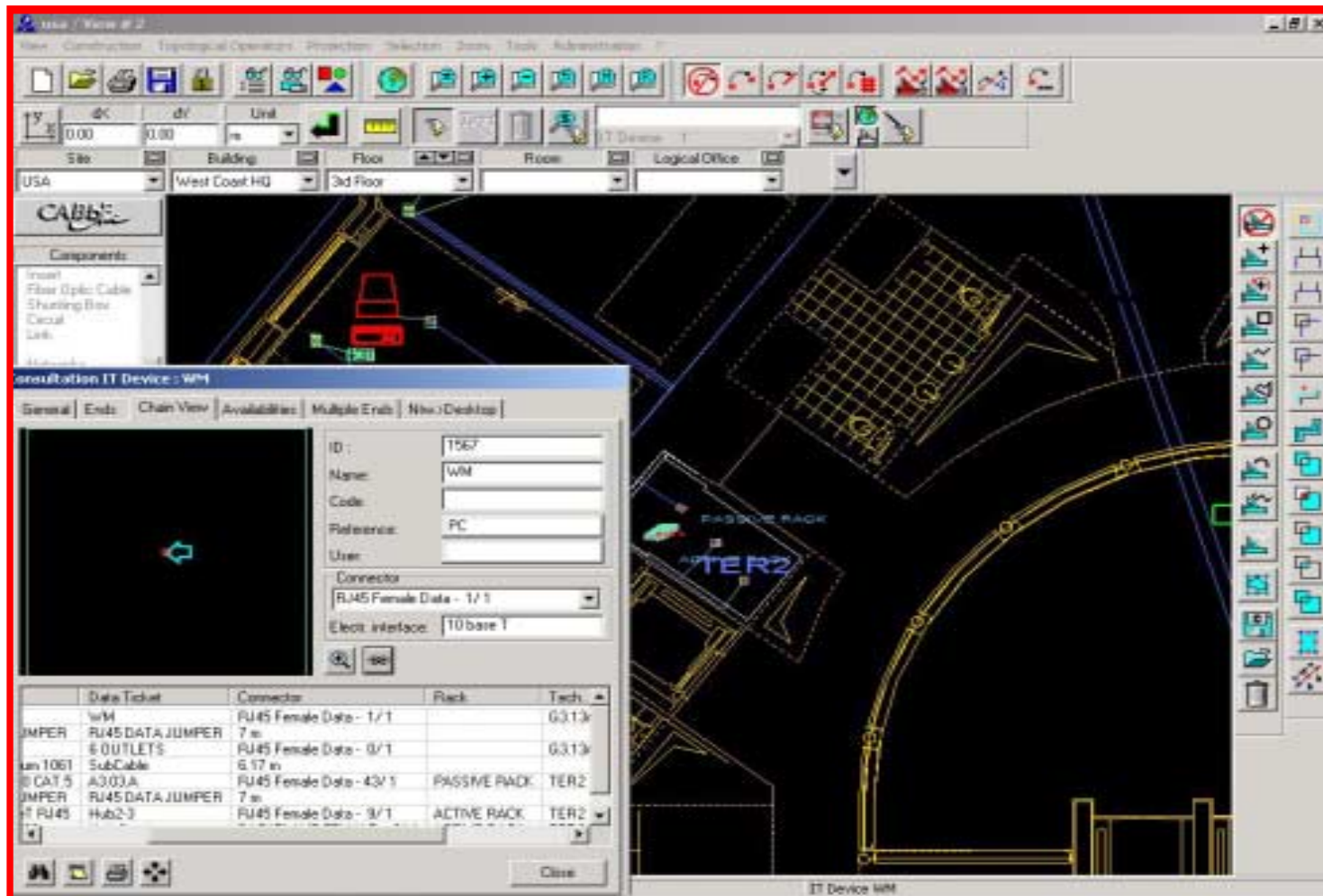

GIS Database Tool Absia's Building One

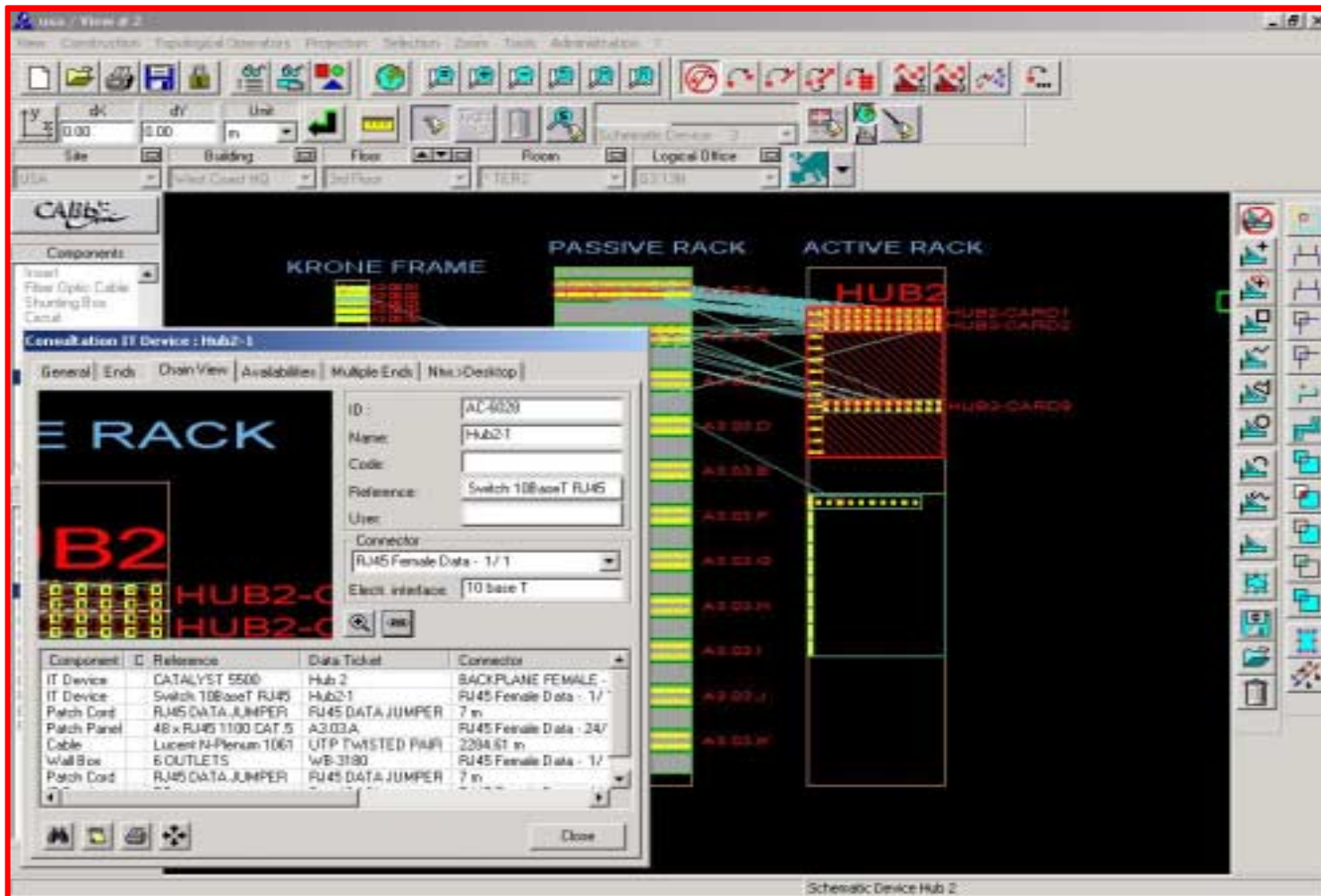

LCC Recommendations Commerce and Santa Fe Springs

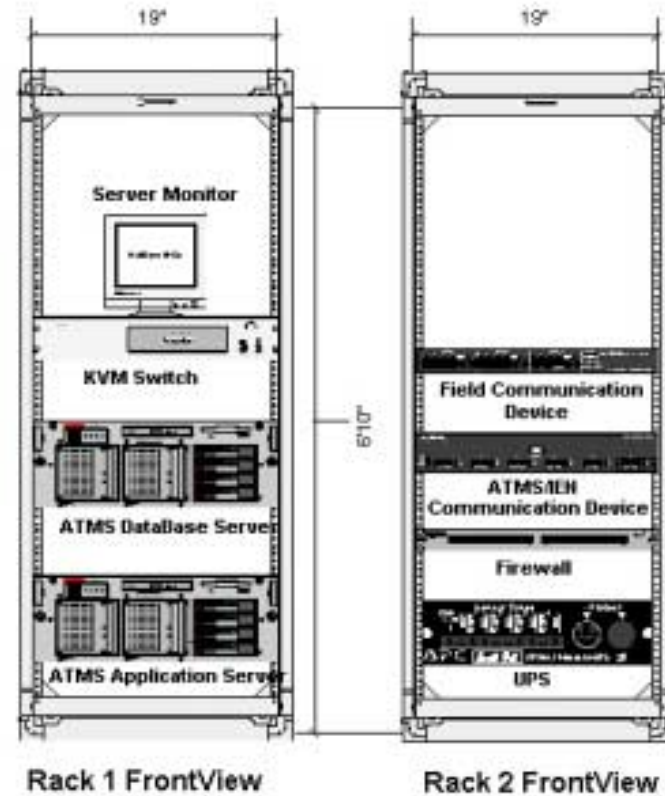
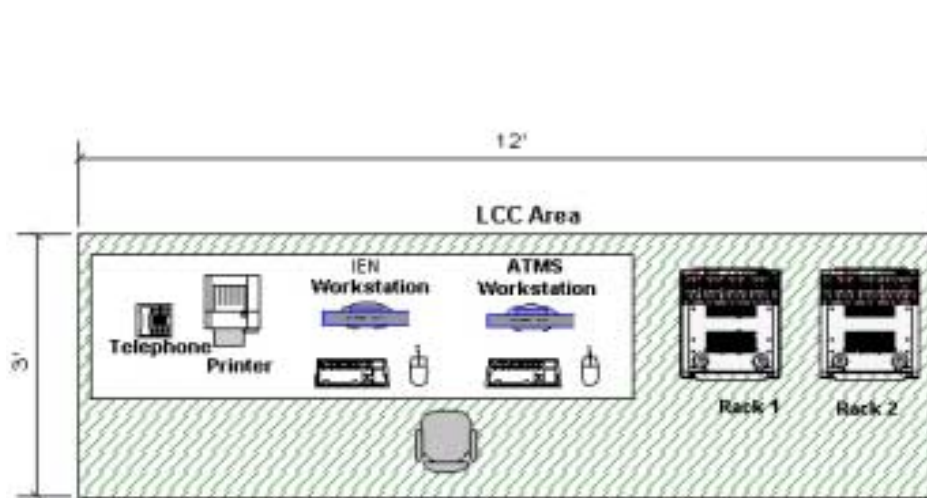

LCC Recommendations Downey 2nd Floor

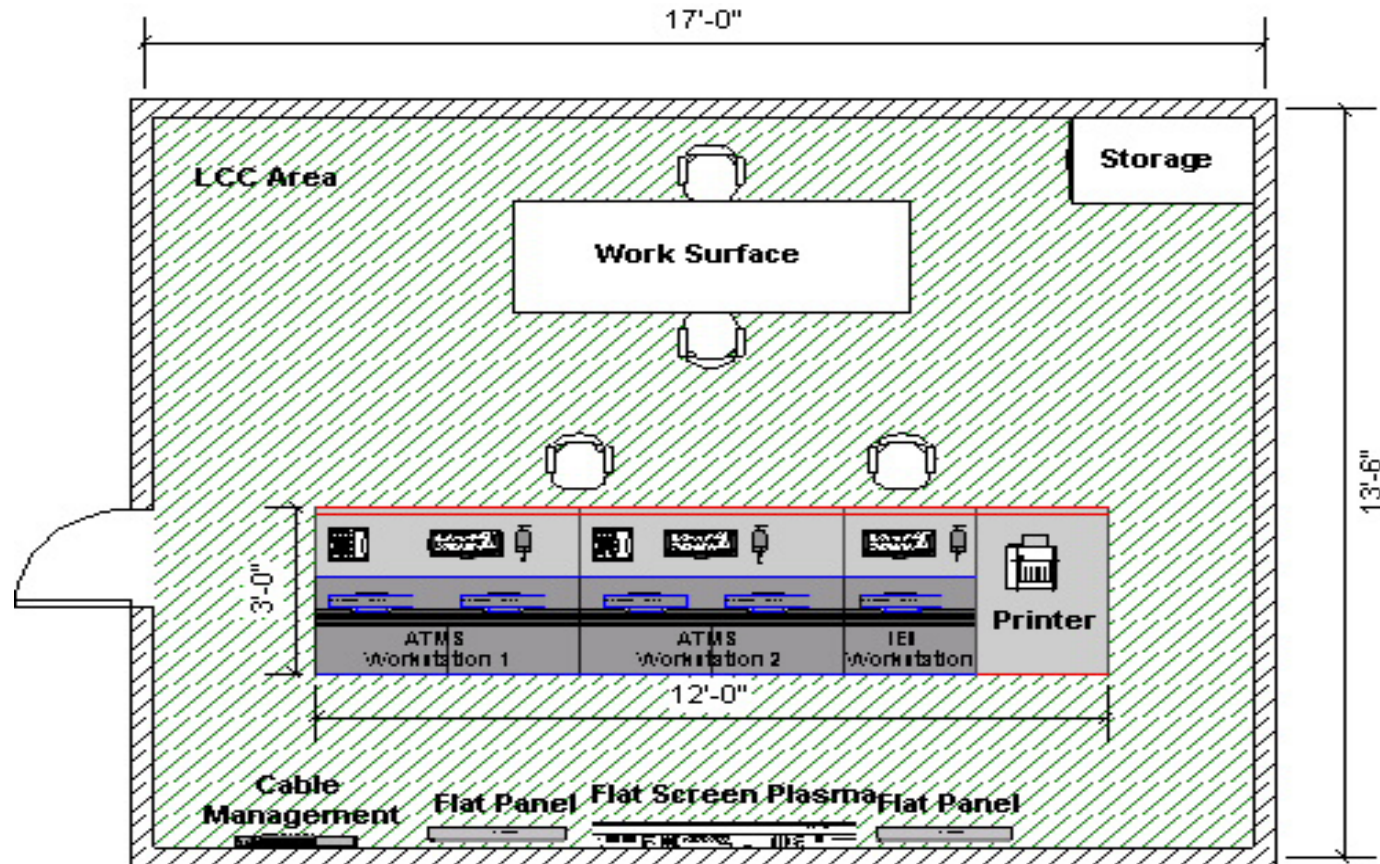

LCC Recommendations Downey 3rd Floor

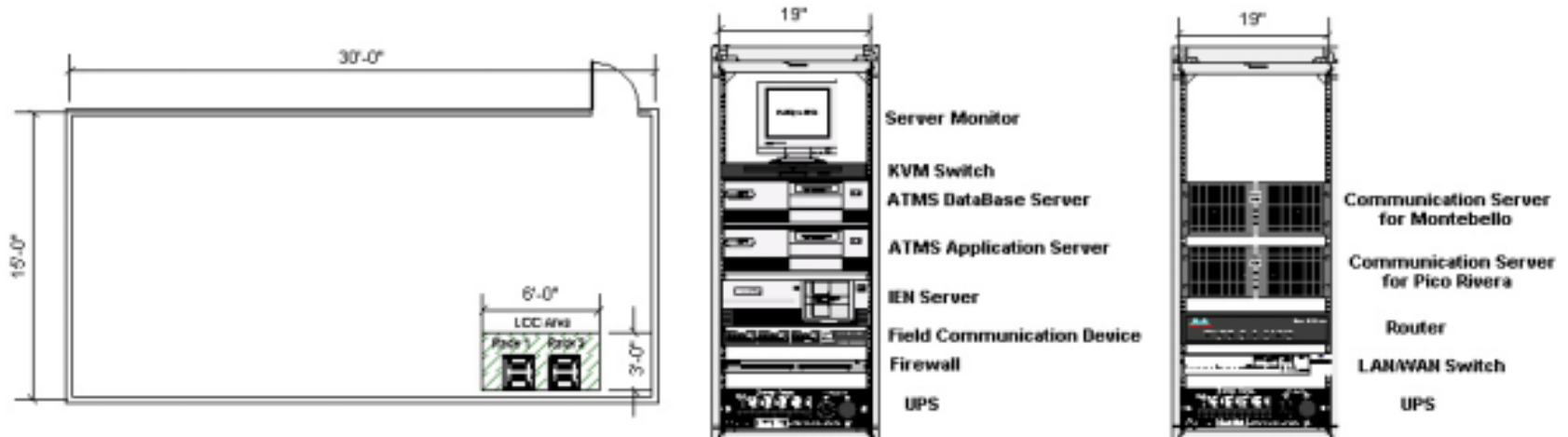

LCC Recommendations

La Mirada, Montebello, Pico Rivera

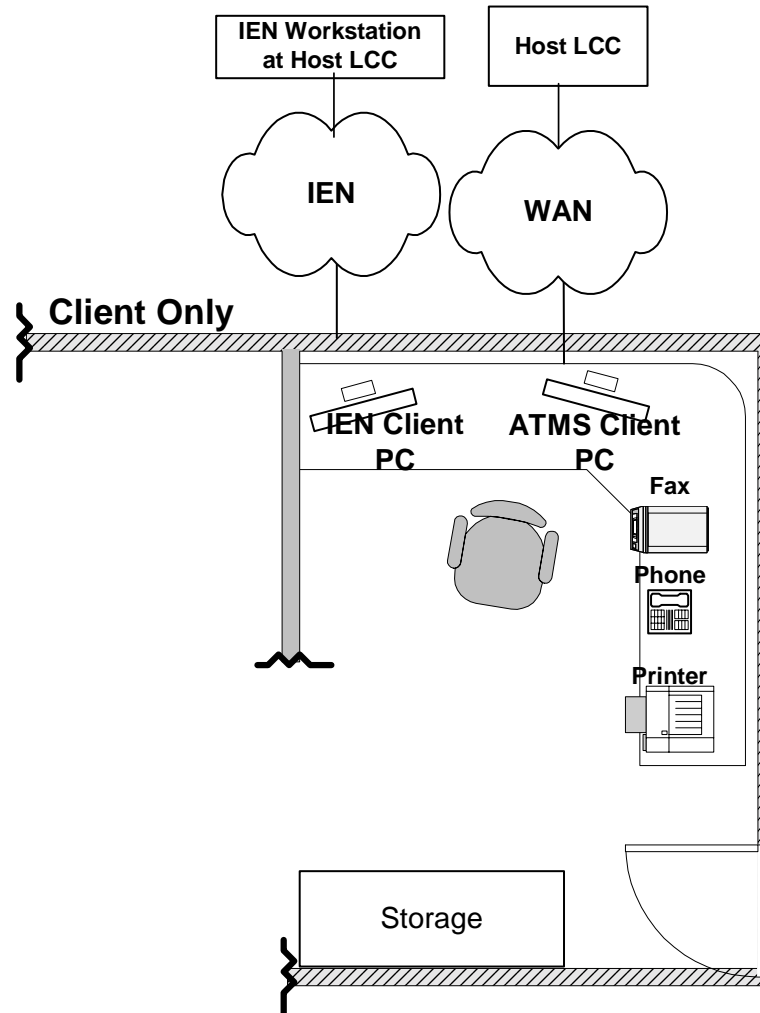

VDS High Level Design Process



- Summarize previously derived Requirements
- Identify Candidate Detection Technologies
- Assess by Comparative Analysis
- Make Recommendations



Candidate Detection Technologies

- Inductive Loop
- Microwave (RTMS)
- Video Image Detection (AutoScope)
- Issues:
 - Equipment Installation
 - Configuration
 - Communications to Central



Summary of Recommended Choices

Communication at Site

| Criterion | Technology | Communication Medium |
|-----------------|------------|-----------------------|
| Accuracy | Loops | Twisted-Pair or Fiber |
| Stopped Vehicle | VIDS | Twisted Pair or Fiber |
| Video (Still) | VIDS | Twisted Pair or Fiber |
| Video (Motion) | VIDS | Fiber |
| Cost | RTMS | Twisted Pair or Fiber |

No Communication at Site

| Criterion | Technology | Communication Medium |
|-----------------|------------|----------------------|
| Stopped vehicle | VIDS | CDPD |
| Video (Still) | VIDS | CDPD |
| Cost | RTMS | CDPD |

VDS Location

Advanced Detection and System Detection



- Advanced Detection –
 - Used for traffic operations – traffic responsive operation
 - Data can also be used for measurement of congestion Unless
 - Intersections are far spaced
 - Queues are expected to back-up to the location of advanced detectors
- System Detection
 - Used for collecting congestion data
 - Location needs to represent free flow conditions
- Recommendation For I-5/Telegraph Road
 - Install Advanced Detection at all intersections where detection is required for traffic operations
 - Use Advanced detectors as System detectors unless distance between the intersections warrants mid-block detection and/or data exists to show queue back-up to advanced detector locations



Communications Analysis

- Contents:
 - Field/IEN Network Descriptions
 - Discussion of Video Architectures
 - Requirements Summary
 - Candidate Technology Description
 - Comparative Analysis
 - Recommendations for:
 - Field Communications
 - IEN Communications



CCTV Requirements

- CCTV system should be integrated with ATMS
- The communications system shall support the ability to view and control (Pan, Tilt and Zoom) CCTV cameras.
- Analog: The communications system shall accommodate the standard NTSC bandwidth for video of 4.2 MHz based on a 6 MHz channel spacing for video signals.
- Digital: Either motion JPEG or MPEG formats should be used.
- Control: The control signal, ranging from 300 bps to 9600 bps will be accommodated over a common channel in a multi-dropped environment

CCTV Requirements



- The CCTV interface to the IEN shall support the sharing of full motion video from any of the cameras under the control of the ATMS with jurisdictions in the corridor and elsewhere.
- It shall be possible for all the agencies in the I-5/Telegraph Road Corridor to concurrently view any CCTV image.
- The CCTV interface to the IEN shall support the control of CCTV cameras by other agencies.



Physical Communications Architecture

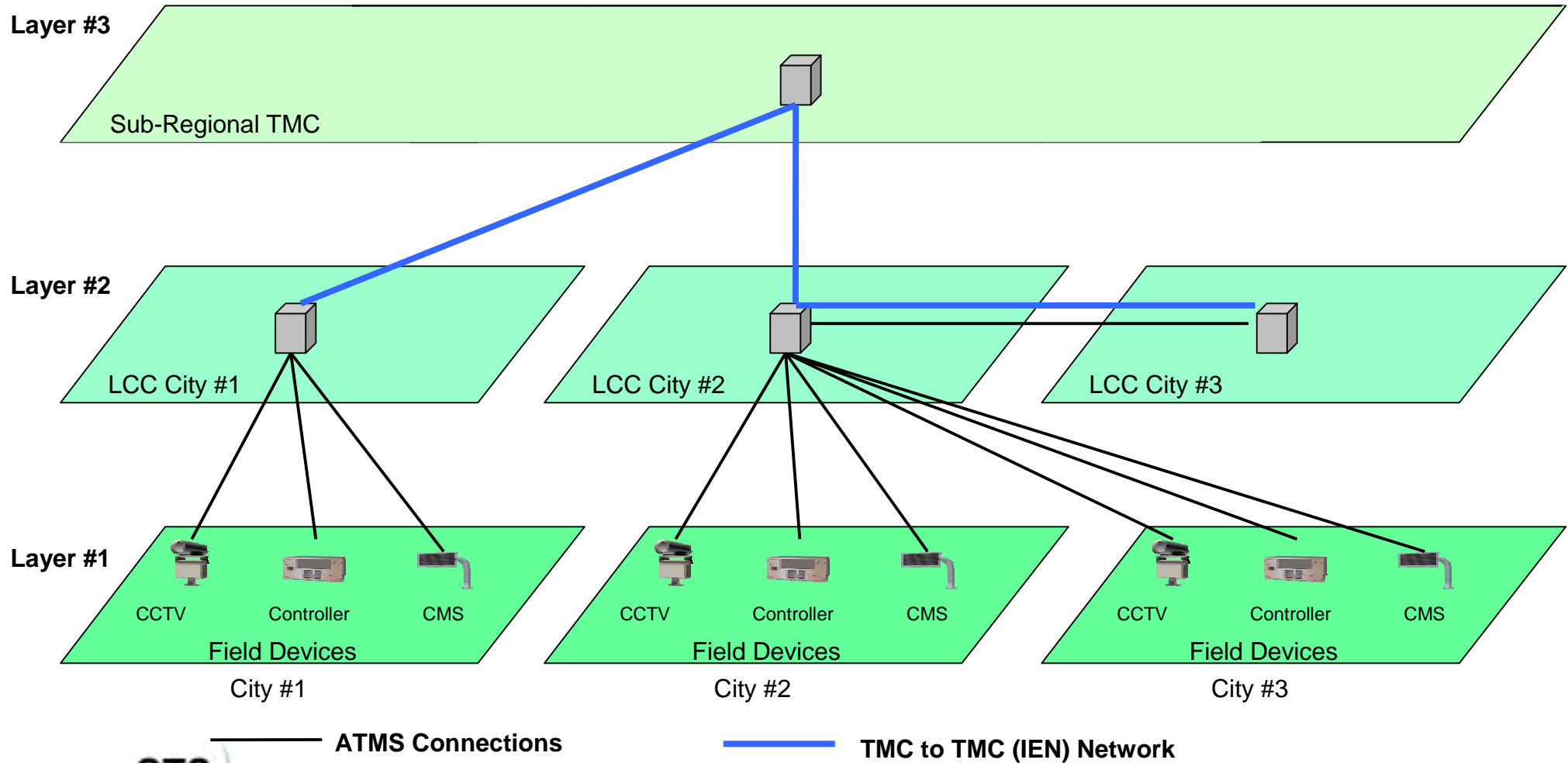

Video Communication Option #1

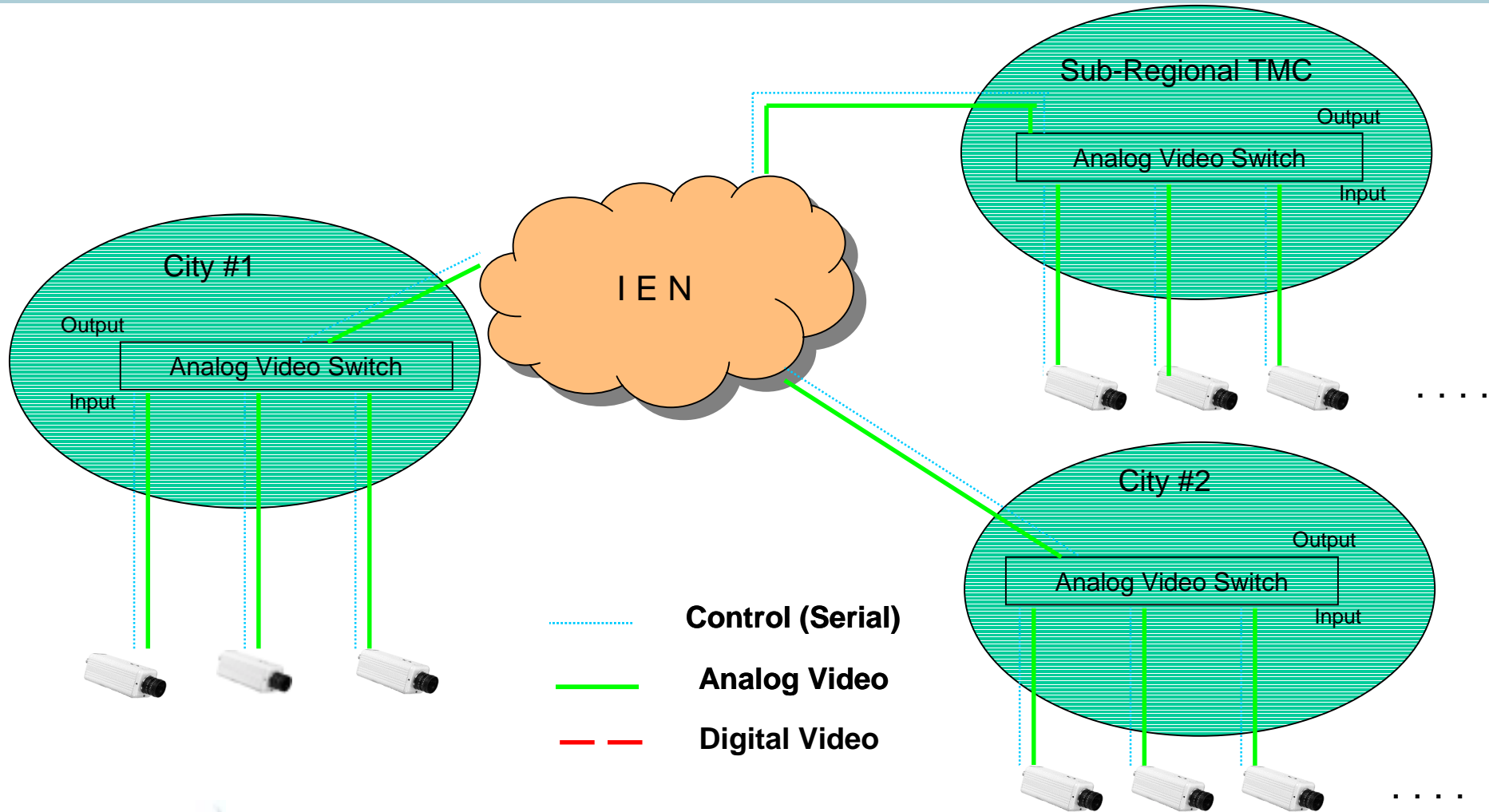

Video Communication Option #2

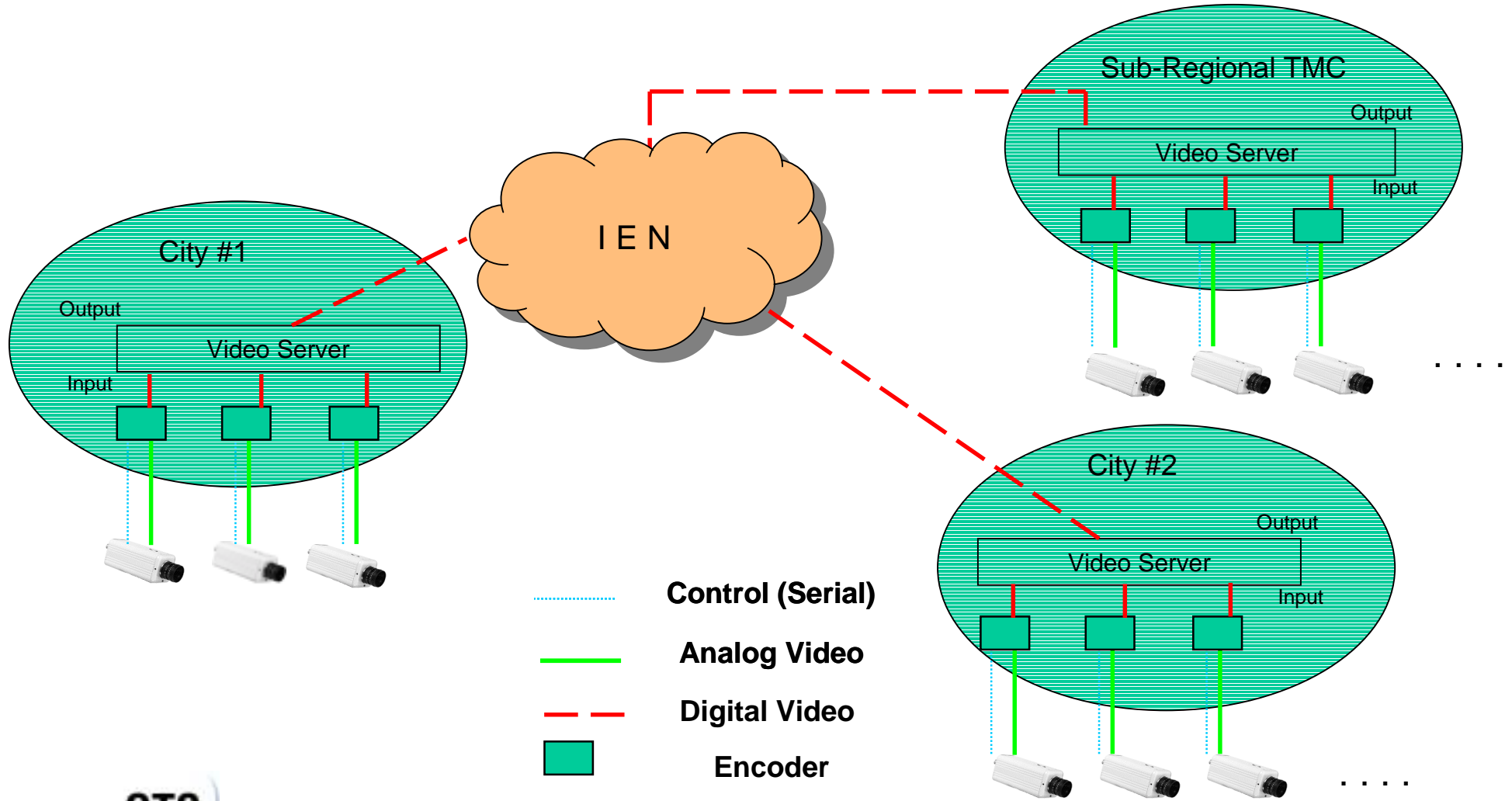

- ⋯ Control (Serial)
- Analog Video
- - - Digital Video
- Encoder

Video Communication Option #3

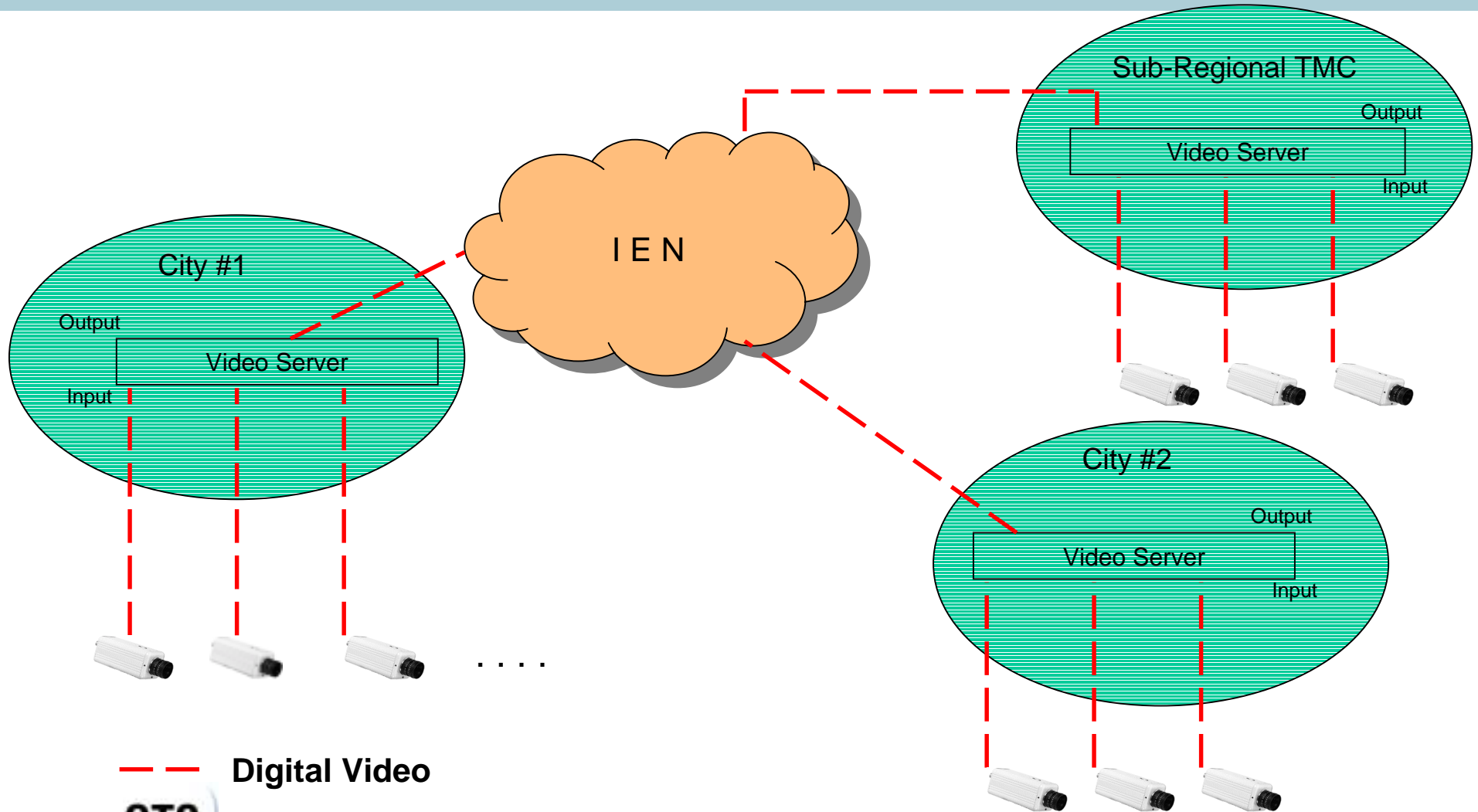



Comparison of Video Architecture Options

| | Option # 1 | Option # 2 | Option # 3 |
|-------------------------|---|--|---|
| Type of video available | <ul style="list-style-type: none"> • Baseband video | <ul style="list-style-type: none"> • Baseband at TMC • Digital compressed over IEN | <ul style="list-style-type: none"> • Digital compressed |
| Switching Logic | <ul style="list-style-type: none"> • Complex due to protocol | <ul style="list-style-type: none"> • Video Server distributes video | <ul style="list-style-type: none"> • Video Server distributes video. |
| Scalability | <ul style="list-style-type: none"> • Not easily scalable | <ul style="list-style-type: none"> • Moderately scalable | <ul style="list-style-type: none"> • Very easily scalable |
| PTZ Control | <ul style="list-style-type: none"> • Very responsive, low latency | <ul style="list-style-type: none"> • Very responsive at local TMC • Added latency via the IEN for other agencies | <ul style="list-style-type: none"> • Performance impact depending on number of users |
| User Access / Security | <ul style="list-style-type: none"> • Dependent on the video switch | <ul style="list-style-type: none"> • Controlled at the TMC Video server level | <ul style="list-style-type: none"> • Very flexible, but needs careful planning |



Candidate Technologies

- Cable Based Solutions
 - Twisted Pair
 - Fiber
 - Analog/Sonet/ATM/Ethernet
- Wireless based Solutions
 - Microwave
 - Radio
 - CDPD
- Leased Options
 - Frame Relay ISDN/DSL/T-1 etc.
 - Private Virtual Network



Project Area Expansion

- The original scope of work for I-5/Telegraph included only one arterial- I-5/Telegraph Road and involved following six cities:
 - City of Commerce
 - City of Montebello
 - City of Pico Rivera
 - City of Downey
 - City of Santa Fe Springs
 - City of La Mirada
- County expand the coverage area to include more north south and east west streets and covered two more cities: Whittier and Norwalk



Expanded Project Area





Up-coming Work

- Finalize HLD Report (November)
- Finalize LCC Site Recommendations (November)
- Draft Alternatives Analysis (November)
 - ATMS
 - Communications
- Draft Recommendations (December)
 - ATMS/Detection/Communications
- Draft Conceptual Design (January)

Project Web Page



www.gts.sea.siemens.com