

---

# LA RIVER

---

# MASTER

---

# PLAN

---

**APPENDIX VOLUME I**

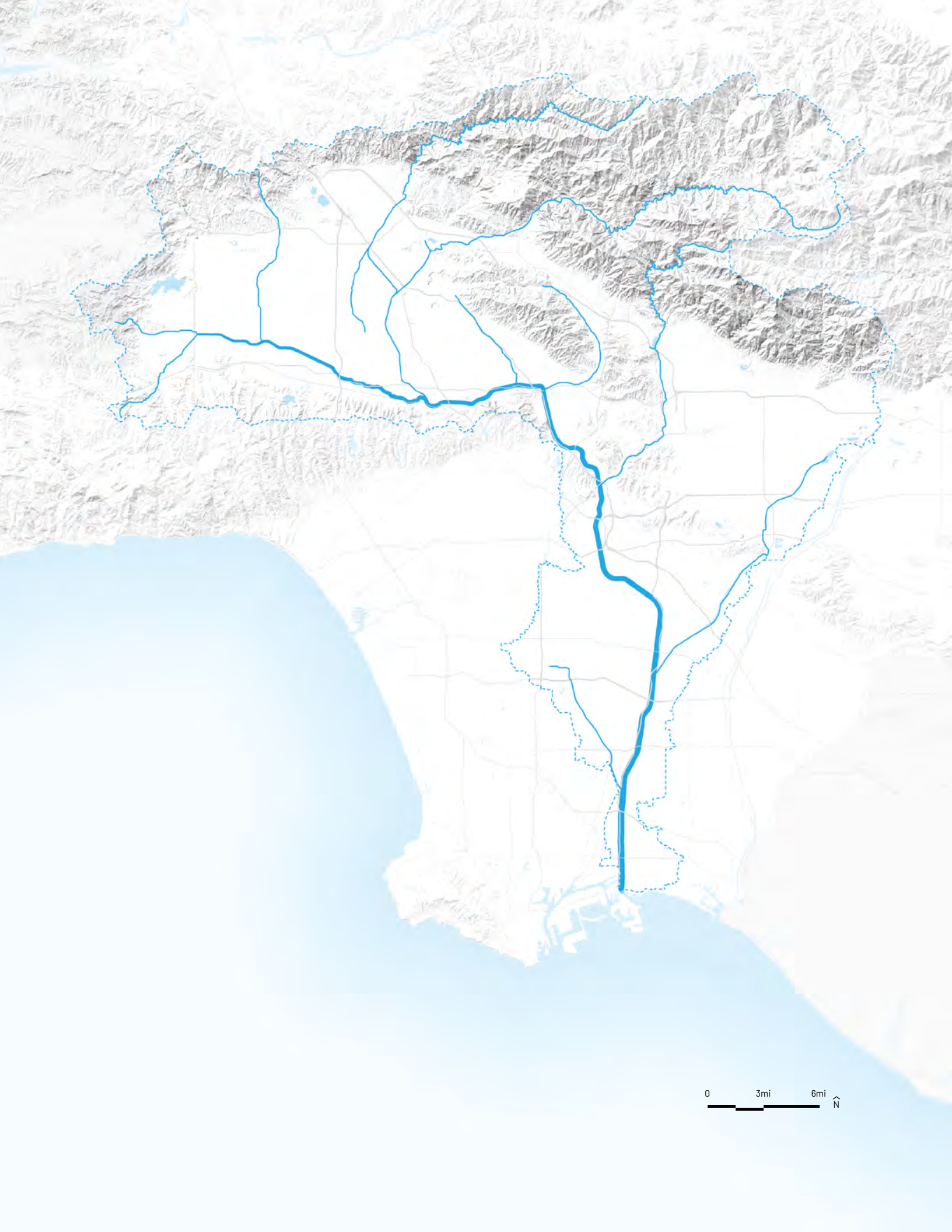
**DESIGN GUIDELINES**



JUNE 2022







0 3mi 6mi  $\hat{N}$



**PREPARED FOR:  
LOS ANGELES COUNTY AND LOS ANGELES COUNTY PUBLIC WORKS**



---

**THIS BOOK IS APPENDIX VOLUME I FOR THE LA RIVER MASTER PLAN**

**These guidelines represent the Flood Control District permit requirements. Project proponents are responsible for implementing these guidelines in accordance with prevailing codes, LA County policies, and other authorities having jurisdiction.**

**While these guidelines are specific to the LA River, certain approaches and techniques may be applicable to other rivers and tributaries in LA County.**

PREPARED BY:

**Geosyntec<sup>®</sup> OLIN Gehry Partners, LLP**

# TABLE OF CONTENTS

---

<b>RELATED DOCUMENTS:</b>	86	Gateways
<b>LA River Master Plan</b>	88	Bridges
<b>Appendix Volume I: Design Guidelines</b>	94	Access and Mobility Checklist
<hr/>		
<b>SECTION I: INTRODUCTION</b>	<b>97</b>	<b>4. Environmental Graphics</b>
<b>11 1. Executive Summary</b>	98	What's in the Chapter
12 About the Guidelines	100	Standard Design Features
	105	Sequence and Placement of Environmental Graphics
<b>15 2. Design Considerations</b>	113	Suite of LA River Environmental Graphics
17 LA River Right-of-Way and Channel	118	Informational
18 Programming and Engagement	121	Regulatory
20 Project Programming	126	Confirmation
22 Principles of Design	131	Interpretive
26 Integration of Arts and Culture	136	Directional
30 Ongoing Project Success	145	River Mile Markers
32 Permitting	147	River Mile Pavement Markings
34 LACFCD Permitting Checklist	148	River Mile Marker and Pavement Marking Placement
38 Other Permits	151	Large Scale Icon Graphics
40 Planning Frames	152	Community Expression
	154	Installation & Maintenance
<b>SECTION II: DESIGN GUIDELINES</b>	<b>158</b>	Environmental Graphics Checklist
<b>63 3. Access and Mobility</b>		
64 What's in the Chapter		
66 Multiuse Trails		
69 Trail Components	<b>161</b>	<b>5. Ecology, Habitat, and Planting</b>
70 Right-of-Way Combinations	162	What's in the Chapter
72 Trails in Wide Right-of-Way Areas	164	Considerations for Ecological Project Success
73 Trails in Narrow Right-of-Way Areas	166	Setbacks and Buffers
78 Trail Assemblies	168	Planting Along Levees and Floodwalls
81 Paving Materials	170	Maintenance Buffers and Clearances
83 Fences, Guardrails, Railings, and Gates	172	Rights-of-Way

174	Safety Best Practices Along the River	332	Pavilion Components
176	Planted Buffers	340	Pavilion Configurations
178	Stormwater Best Management Practices	342	Shade Pavilions (Tier I)
183	Channel Modifications: Innovation	346	Rest Pavilions (Tier II)
184	Channel Modifications: Trapezoidal Channel	350	Gathering Pavilions (Tier III)
186	Channel Modifications: Rectangular Channel	354	Pavilion Best Practices
188	Platform Parks	356	Common Elements: Site Furnishings
190	Productive Landscapes	358	Site Furnishings: Litter and Recycling Receptacles
193	Tree and Plant Protection	359	Site Furnishings: Bike Racks
194	Site Preparation and Soil	360	Site Furnishings: Benches
196	Tree and Shrub Planting	361	Site Furnishings: Drinking Fountains
198	Maintenance Best Practices	362	Site Furnishings: Lighting
200	Walls	365	Site Furnishings: Emergency Call Boxes
203	Slope Stabilization and Erosion Management	366	Site Furnishings: Recreation
204	Wildfire	368	Facilities and Amenities Checklist
206	Strategies for Creating Habitat	<b>SECTION III: RESOURCES</b>	
210	Habitat Areas: Off-Channel Fishing Amenities	<b>372</b>	<b>Glossary</b>
212	Plant Communities	<b>377</b>	<b>Resource List</b>
214	Native Plant Species Appropriate Use	<b>380</b>	<b>Endnotes</b>
216	Planting Lists	<b>382</b>	<b>Bibliography</b>
316	Ecology, Habitat, and Planting Checklist	<b>386</b>	<b>Table of Figures</b>
<b>325</b>	<b>6. Facilities and Amenities</b>	<b>396</b>	<b>Acknowledgments</b>
326	What's in the Chapter		
328	River Pavilions		
330	Pavilion Cadence		





# SECTION I: INTRODUCTION





Figure 1. The LA River begins at the confluence of Arroyo Calabasas and Bell Creek at river mile 51. Source: OLIN, 2018.



# 1. EXECUTIVE SUMMARY

## ABOUT THE GUIDELINES

The goals of the LA River Master Plan are intended to integrate design and performance objectives in a multi-jurisdictional context. These guidelines will aid designers and engineers in the establishment of a 51-mile connected open space that is a well-organized, functional, and accessible environment reflecting the diverse and shared identities of LA County. To facilitate decision-making and ensure a standard for design, the guidelines present a unified, cohesive identity while promoting best practices and resiliency for the river corridor. Adaptive design considerations and planting palettes for climate change are critical to success. Equally important, the guidelines provide flexibility for site-specific needs and expressions of neighboring communities' cultural identities. With this in mind, a structure is provided to support projects at all scales and help to define the look and feel of the LA River corridor.



**Figure 2.** The LA River brings people and communities together in more ways than one, as can be seen in this photo of the SELA Arts Festival at river mile 11.7 in July 2018. Source: OLIN, 2018.

## ABOUT THE GUIDELINES

The document is organized into four chapters, focusing on elements ranging from trails to environmental graphics to habitat to facilities. Rather than requiring one set of fixed solutions for all 51 miles, these guidelines promote the idea of a consistent approach with reach-specific identity within the greater whole. Ecology, habitat, and art should all reflect the physiography or culture of a specific reach of the river. Other elements, such as environmental graphics, access points, and lighting should be unified to ensure connectivity, wayfinding, and equitable access. In all cases, the adjacent communities should be understood for improvements along the river corridor to have the appropriate scale and feel for the neighborhood.

To address the need for site-specific approaches, the design guidelines have been organized through the nine planning frames established in the Master Plan. The beginning of every chapter has a key map which functions as a visual index for the reader to link to applicable guidelines for each frame of the river. These context-based guidelines will allow the reader to quickly identify

key areas or topics of concern related to the reach. Lists, references, and sources that cover the entire river are located at the end of this document.

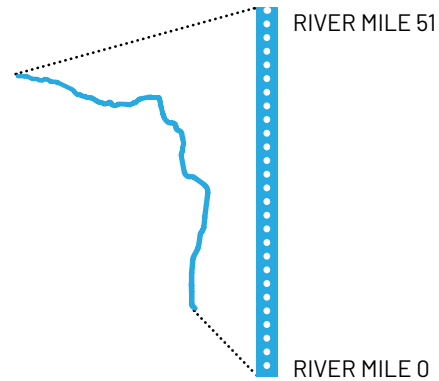
Design guidelines are not a ‘cookbook’ for the design process for sites; rather, they are the frame for good project development. The knowledge and experience of landscape architects, engineers, architects, botanists, ecologists, and artists are invaluable in creating spaces that enhance life along the river. The LA River Master Plan Design Guidelines are a tool for these professionals and reflect the baseline of values for promoting smart design along the river corridor.

### THE ROLE OF LA COUNTY

The LA County Flood Control District was established to provide flood risk reduction, water conservation, recreation, and aesthetic enhancement for cities and unincorporated areas in LA County outside of the Antelope Valley. LA County Public Works, which is responsible for the planning and operational activities of the Flood Control District, served as the lead agency for



**DESIGN GUIDELINES ARE NOT A 'COOKBOOK' FOR THE DESIGN PROCESS FOR SITES, RATHER THEY ARE THE FRAME FOR GOOD PROJECT DEVELOPMENT**



The river ruler is a vertical, straight-line representation of the 51 miles of the LA River.

development of the LA River Master Plan (1996, updated in 2020). The reimagined river envisioned in that plan promotes 51 miles of connected open space, which will require a concerted and sustained effort by many LA County agencies, in cooperation with incorporated cities. The guidelines contained in this book apply to areas of the LA River corridor maintained, operated, or owned by LA County (typically referred to as the right-of-way) and all projects permitted by LA County Public Works along the LA River.

## LA RIVER MILES

The LA River is 51 miles long, flowing from mile 51 in Canoga Park within the City of LA to mile 0 at Long Beach where the river meets the Pacific Ocean. The river mile system was developed in 2016 to reduce confusion between different jurisdictional reach designations.

Referencing this consistent numbering system is required for all LA County Public Works projects permitted under these guidelines.

## RIVER RULER

The LA River is a complex system with many layers of information and data. To better understand the data available for the river and new data that was created as part of the Master Plan process, the LA River Master Plan used LA River Rulers to organize and collect data.

The river ruler is a vertical, straight-line diagram that represents and takes measure of the entire 51 miles of the LA River. Straightening the river simplifies and reinforces its linearity, allowing the eye to quickly perceive how conditions along the river change from one river mile to the next.

The vertical axis of the river ruler represents the 51 miles of the LA River starting at mile 51 in the West San Fernando Valley at Canoga Park to river mile 0 at Long Beach.





Figure 3. The LA River channel has two different profiles: box and trapezoid. This section of box channel runs through Studio City, near river mile 39. Source: OLIN, 2018.



# 2.

## DESIGN CONSIDERATIONS

### THE DESIGN PROCESS

Excellence in design enhances function. From the earliest stages of project development, it is important to consider how a project can be aesthetically engaging while addressing multiple needs of adjacent communities. Design excellence requires an attention to quality of built structures, the landscape, the way buildings and landscapes interact with each other, and how projects interface with the river and surrounding communities. Elevating the quality of design along the LA River will also serve to elevate the level of design across LA County. The design process should include consideration of the LA River channel, the design principles outlined in this chapter, adjacent communities, and the LA River Master Plan.



Figure 4. Certain reaches of the LA River, such as this segment near river mile 25, are soft-bottom rather than concrete. Source: OLIN, 2018.



Figure 5. Certain reaches of the river, such as this segment at river mile 14, are entrenched rather than leveed. Source: OLIN, 2018.

## LA RIVER RIGHT-OF-WAY AND CHANNEL

The 51-mile LA River is an engineered channel designed in response to historic flood events to convey stormwater to the Pacific Ocean as quickly and efficiently as possible. The material, shape, and size of the river changes along its length.

More than 75% of the length of the river has a concrete bed. The river has a “soft bottom” earthen riverbed in the Glendale Narrows, the Sepulveda Flood Control Basin, and the Estuary region. If not maintained, the soft bottom reaches can become heavily vegetated, often with invasive species, which decreases conveyance capacity.

The shape of the LA River channel is predominantly trapezoidal, with sides that flare out as they move up and away from the bottom of the channel. Rectangular sections of the channel, where its sides are completely vertical, are limited to the San Fernando Valley between Sherman Oaks and Burbank and a one-mile stretch near Vernon. To manage additional flood risk, the sides of the channel are often higher than the ground level of surrounding communities, forming levees or flood walls.

The width of the channel generally increases going downstream, from Canoga Park to Long Beach, to account for the increasing accumulation of runoff and changes in the channel’s slope. At its narrowest, between Sherman Oaks and Studio City, the channel is about 55 feet wide. At its widest, where the river meets the Pacific Ocean, the channel is more than ten times that width.

The LA River right-of-way includes the entirety of the river channel as well as landside areas immediately adjacent to the channel banks that facilitate continuous operations and maintenance access by the LA County Flood Control District (LACFCD). About 21% of the river’s two banks are constrained, with less than the 12 feet of landside area width that the LACFCD seeks to have for routine operations and maintenance. In some areas, particularly south of Compton, the landside area can surpass 100 or 200 feet in width.

## THE KIT OF PARTS MATRIX CONNECTS DESIGN COMPONENTS TO THE NINE MASTER PLAN GOALS

# PROGRAMMING AND ENGAGEMENT

Each project along the LA River should respond to the needs of adjacent communities. The LA River Master Plan identifies needs along the river for each of the plan's nine goals. The goals can be used to determine appropriate interventions in a particular project location.

### Goals of the LA River Master Plan

- Reduce flood risk and improve resiliency.
- Provide equitable, inclusive, and safe parks, open space, and trails.
- Support healthy, connected ecosystems.
- Enhance opportunities for equitable access to the river corridor.
- Embrace and enhance opportunities for arts and culture.
- Address potential adverse impacts to housing affordability and people experiencing homelessness.
- Foster opportunities for continued community engagement, development, and education.
- Improve local water supply reliability.
- Promote healthy, safe, clean water.

Over time, a community's needs may shift, so robust community engagement must be built into all projects.

### KIT OF PARTS AND COMMON ELEMENTS

The LA River Master Plan utilizes a kit of parts that includes possible design strategies for sites along the LA River. Each strategy is associated with certain Master Plan goals. The kit of parts is a recommended collection of multi-benefit design components organized within six major infrastructure and urban river typologies. These include: trails and access gateways, channel modifications, crossings and platforms, diversions, floodplain reclamation, and off-channel land assets.

In addition to the project-scaled design components in the kit of parts, smaller common design elements include pavilions, access stairs and ramps, and site furnishing such as lights, hygiene facilities, seating, trash and recycling, water fountains, guardrails, gates, bike racks, environmental graphics, emergency call boxes, and art.





Figure 6. Design strategies can be categorized into six infrastructure and urban river typologies. See Chapter 8 in the LA River Master Plan for more information. Source: LA River Master Plan, 2020.

IMPACT	ACREAGE / LENGTH	OCCUPANT RANGE
<b>XL</b>	> 150 acres or > 10 miles	>5,000
<b>L</b>	40 - 150 acres or 5 - 10 miles	1,000 - 10,000
<b>M</b>	< 40 acres or < 5 miles	100 - 5,000
<hr/>		
<b>S</b>	1 - 3 acres / 1 - 5 miles	5 - 500
<b>XS</b>	< 1 acres / < 1 miles	n/a

Figure 7. The LA River Master Plan proposes five scales of impact for sites along the river: XS, S, M, L, XL. Each scale has varying needs for facilities, amenities, gathering spaces, performance areas, and recreation.

## PROJECT PROGRAMMING

Project programming should be completed for each project based on their anticipated uses, size, and occupancy loads. The LA River Master Plan proposes five scales of sites along the river.

Each scale of project has varying needs for facilities, amenities, gathering spaces, performance areas, and recreation.

Medium (M), large (L), and extra-large (XL) projects in the LA River Master Plan are defined as projects greater than 5 acres, and they may include hundreds of acres. Projects of a smaller acreage may also be included in a larger category based on their ability to serve very high adjacent community needs. For example, a large performing arts center on a single acre of land may positively impact many community needs and, thus, qualify as a large project.

Depending on the scale and typology of the project, it is useful to plan for spaces that can flexibly accommodate smaller day-to-day uses as well as larger events such as festivals or recreation events.

Generally, M projects should accommodate between 100-5,000 occupants.

L projects should accommodate between 1,000-10,000 occupants.

XL projects should have spaces for large gatherings of hundreds, and in some cases thousands of people. They should accommodate more than 5,000 occupants.

**PROJECTS OF A SMALLER ACREAGE  
MAY ALSO BE INCLUDED IN A LARGER  
CATEGORY BASED ON THEIR ABILITY  
TO SERVE VERY HIGH ADJACENT  
COMMUNITY NEEDS**

---

S and XS projects are very different than their larger counterparts. An extra-small project may be as limited as the installation of a bench, sign, light pole, or sculpture. Access points, gateways, and other amenities commonly fall in this category.

XS and S projects may also take the form of river pavilions, typically sites under a quarter acre and a quarter to a full acre, respectively. They have an approximate building square footage range of 250 to 10,500 square feet and have occupancies between 5 and 500 occupants. Chapter 6, Facilities and Amenities, outlines specific design criteria for the river pavilions, which range in size to accommodate varying activities and programs. Shade Pavilions (Tier I), the smallest pavilions with the simplest programming, should accommodate 5 to 20 occupants. Rest Pavilions (Tier II) that offer enhanced programming such as restrooms, a snack station, and picnic table, should accommodate 20 to 50 occupants. Gathering Pavilions (Tier III), those with the most substantive facilities and amenities such as a cafe, locker room, and bike rental station, should accommodate 50 to 500 occupants. However, some XS and S projects may have more significant facilities that necessitate increased area and result in a higher occupancy.



**Figure 8. (Top) The LA River can host community performances, such as the one shown in the image by a local high school at the SELA Arts Festival at river mile 11.7.**

Source: OLIN, 2018.

**Figure 9. (Middle) Local Artists, such as Leo Limon, utilize the LA River as a canvas. Source: Leo Limon, 2010.**

**Figure 10. (Bottom) The LA River is an important resource to the Indigenous Peoples of Los Angeles. This images shows the Native American Veterans Association's annual Veterans Appreciation and Heritage Pow Wow at river mile 13.**

Source: Marvin Lynchard, 2014.



THE GOAL IS TO CREATE A  
COMPLEMENTARY APPROACH  
BETWEEN WHAT IS SHARED  
AND WHAT IS UNIQUE WITHIN EACH  
FRAME, NEIGHBORHOOD, AND  
ENVIRONMENT ALONG THE RIVER

---

## PRINCIPLES OF DESIGN

### A UNIQUE AND SHARED RIVER COMMONS

The design of plantings, structures, buildings, and trails should share some common attributes along the river course. For residents and visitors, this means it should be apparent when they are in the LA River corridor commons. The goal is to create a complementary approach between what is shared and what is unique along each frame, neighborhood, and environment along the river. The balance between celebrating the unique and providing a common design formality should not be a heavy-handed exercise. There are so many iconic vistas along the river: Sepulveda Basin, Griffith Park, the Glendale Narrows, the historic bridges crossing over the river in downtown City of LA, the rising 6th Street Viaduct, Hollydale Park, the Dominguez Gap Wetlands, and the Long Beach Estuary, to name a few. The shared identity should be a common platform for connecting and celebrating these destinations and future sites of interest.

The most logical way to do this is to create a trail identity that unites and connects just as the river corridor itself does: connective elements such as trail dimensions, path materiality, lighting, artwork, and environmental graphics should create this common identity. By contrast, points of arrival, vistas, and destinations should be inspired by high design ambition, community context, and environmental resilience. Ultimately, the common connection and destinations along the river should reveal a greater understanding of the river itself as a unique and diverse commons serving the people of LA County.



Figure 11. Projects along the LA River should improve ecosystem function and provide educational opportunities. Source: OLIN, 2019.

## PROSPECT AND REFUGE

For the river to be connective it must be inclusive, inviting, and useful to everyday life. Design is not a formula, but there are underlying fundamentals that all good design includes. One is to provide places of prospect (views) to see the greater landscape—to observe people and natural phenomena—and to be a safe place for all to use and enjoy.

A successful public space is a destination within the public realm that encourages social interaction and a sense of community. A sense of unease can accompany places that are vacant, missing convenient crossings, or have difficult and obscured lines of sight. Every destination and path along the river should be readily accessed and exited within no more than a half mile. Open spaces must be programmed to support a diversity of regular users. The strategies employed may vary and need not be complex; an extraordinary natural view, places to perch and observe activity in comfort and shade, areas to watch active gameplay or see a performance or an all ages adventure playground can all serve as strong attractors. In combination with comfort and convenient access, these places will be safe, vital, and attractive.

## SAFETY

Of paramount concern is that the river is safe for all and that the feeling of safety is perceptible. To ensure safety along the river, the guidelines have developed a framework of environmental design that requires projects to maintain: clear lines of sight, provide minimum standards of lighting uniformity along all routes of circulation, and post clear guidance on avoiding flood and storm hazards from within the channel. Every half mile of the river corridor will provide a station for rest and where adjacent to a neighboring community access to and from the river corridor commons. The entirety of the 51 miles of the LA River shall maintain emergency access for first responders and emergency personnel and maintenance vehicles. Ultimately, the river will be maintained for both the personal safety of visitors of the commons and for the protection of life and property along the entire corridor.



Figure 12. Vendors set up booths within the river channel at the SELA Arts Festival at river mile 11.7. Source: OLIN, 2019.





**Figure 13.** The industrial land that hems in the LA River, such as this example at river mile 18, is representative of over 10% of all land within the river corridor. Source: OLIN, 2018.

## CULTURAL IDENTITY

The river is a series of unique communities and environments united by the flow of the river. The corridor is envisioned to strengthen this environmental and cultural asset for the citizens of LA County. All design projects should be informed by the resources, assets, and needs provided by the local context of each mile of the river. The river should reflect the diversity and creativity of LA County, which is a multiracial and multicultural area where most people speak a language other than English. Facilities for the river should acknowledge and be informed by the histories, cultural expressions, and familial uses of communities along the river to maximize local use and authentically reflect the river's diversity.

## CADENCE

To make the 51 miles of the river accessible and useful to the communities of LA County, reliable access to amenities, services, and destination uses should be established. Additionally, there is great value in varied site and community responsive artworks strategically placed along all 51 miles of the river. The planning framework prescribes that these elements occur at regular intervals, or a steady cadence. The intent is to create both equity in access to open space and amenity throughout the river and to improve access and safety while setting reliable expectations for services and facilities along the river.

# INTEGRATION OF ARTS AND CULTURE

Incorporating arts and culture along the LA River is essential to creating a thriving, continuous 51-mile arts and culture corridor as outlined in Goal 5 of the LA River Master Plan. Communities along the LA River should have equitable access to arts and culture assets and programming. This is reinforced by a 2017 LA County Arts and Culture report on the Cultural Equity and Inclusion Initiative, which focuses on inclusive cultural and arts programs for all residents of LA County. Many jurisdictions also have a “percent for art” policy that requires private construction or development projects to invest in public art. Further incentives and new programs supporting arts and culture along the LA River will continue to be developed in the future.

The LA River Master Plan suggests that a methodology should be developed for the inclusive mapping of arts and culture in neighborhoods adjacent to the river. This methodology should be participatory and include informal and improvisational community spaces and groups, as well as temporary art installations and recurring community events and festivals. Mapped assets should also include places, people, and events that convey the cultural heritage of riverside communities. An example of comprehensive field mapping is the City of LA Department of Planning SurveyLA Program, which was completed from 2010 to 2017 and identified historic resources for each community plan area of the city.<sup>1</sup> As development and construction takes place along the river, cultural historic resources need to be safeguarded. Mapping these sites is an important way to ensure the historic and social fabric is not lost or if it is threatened, mitigation is provided.

Innovative approaches to art and design are strongly encouraged in this document. Throughout the design process, there are opportunities at each stage to integrate arts and culture. Designers, lead agencies, and partnering

organizations can maximize the impact of this integration by engaging artists at the earliest stages of a project and considering arts visibility and communication as crucial components of their proposals and implementation strategies. Early inclusion of artists in the project development process ensures that art is part of the overall project vision and site design rather than being a siloed component added on after construction is complete. Arts and culture-led community engagement is a uniquely effective strategy in including the voices of all through creative processes and products. Artists contribute unique perspectives, creative solutions, community and culturally-responsive design solutions and distinctive, place-defining artworks that reinforce a sense of belonging, attachment to place and stewardship of new public assets. For example, LA Metro integrates its arts and design team into early phases of project planning, allowing for the mapping and understanding of existing cultural assets through the incorporation of arts into community engagement.

Public art can play a role in all scales of projects along the LA River. The flexible and inclusive categories of public art include permanent and temporary installations, cultural facilities and uses, environmental graphics, and community engagement and programming. Access to arts education and other informal arts and culture programming is equally as important as permanent art institutions.

Designers can seek guidance and support from the LA County Department of Arts and Culture, municipal arts departments, community arts agencies, and other arts non-profit organizations to facilitate the development of works of public art that celebrates the diverse cultural heritage of the LA River. Examples of public art can be both permanent and temporary installations.

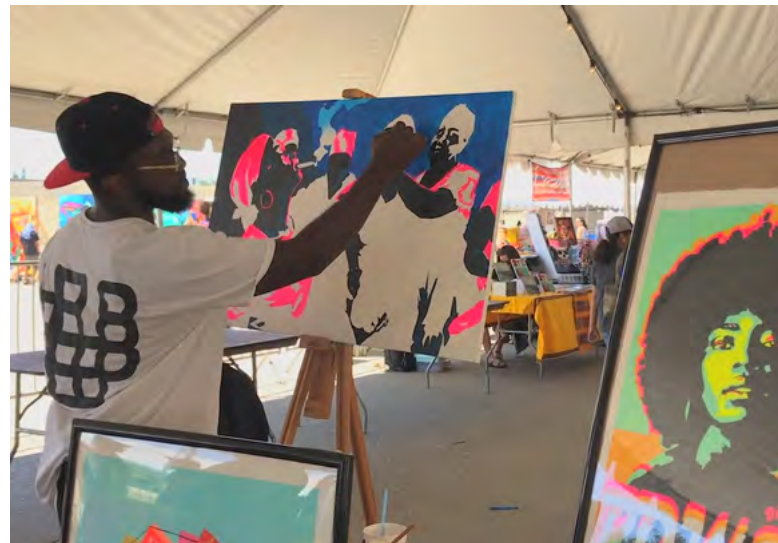


Permanent public art examples include, but are not limited to:

- Sculpture: Free standing, wall supported or suspended, kinetic, electronic or mechanical in material or combination of materials
- Murals, portable paintings, panels, pavers, or tiles
- Earthworks, neon, glass, mosaics, photographs, prints
- Site furnishings or fixtures
- Environmental graphics
- Exhibit or performance space: Public gallery/exhibition space, public performance spaces, public artistic studio spaces, and public art education facilities

Temporary public art examples include, but are not limited to:

- Forms of media including sound, film, holographic, and video systems, hybrids of any media and new genres
- Performing arts: Theatre, dance, music and performance art
- Literary art: Poetry readings and storytelling
- Food culture
- Education programming and arts services
- Special events: Parades, festivals and celebrations
- Arts and culture-led community engagement



**Figure 14. (Top) Le Balet Dembaya, a West African percussion collective, uses the LA River Channel to perform.** Source: Shabaka Johnson, Le Ballet Dembaya.

**Figure 15. (Middle) The LA River can host art shows and exhibitions to showcase local art from community members.** Source: Gehry Partners, 2018.

**Figure 16. (Bottom) Programs such as Turnaround Arts foster art education in schools and communities along the LA River.** Source: Turnaround Arts, California, 2018.



Figure 17. This example of an art installation at a Tier III Pavilion at river mile 28.4 portrays a data-based installation that could show real-time water quality through the color of the lights.

The following should be considered for integration of arts and culture along the LA River:

- Projects should incorporate artists and other arts and culture groups at the earliest phases of project development as an integral part of the design team, drawing from local artists and cultural assets. Art and design can be incorporated into all stages of community engagement.
- Project design teams should consider and highlight the cultural heritage of the site and existing, historic, and indigenous communities for projects along the LA River.

**PUBLIC ART CAN PLAY  
A ROLE IN ALL SCALES  
OF PROJECTS ALONG  
THE LA RIVER**





- Opportunities should be explored for art along the LA River that can be integrated with various aspects of a project. It can become a part of and evolve with the infrastructure of the river itself.
- Design teams should select durable materials appropriate for their application, establish strategies for responsible parties, and identify potential funding scenarios. Additionally, these material selections and strategies should distinguish between requirements for temporary versus permanent installations.
- Arts and culture projects along the LA River must be for all. This especially includes current residents of LA River adjacent neighborhoods who currently may not have access to arts and culture programming.
- Site specific criteria and community input should frame a competitive project selection process.
- Arts and culture projects can include programs and residencies for the incubation of youth and community talent, along with other community programming.

# ONGOING PROJECT SUCCESS

Almost 25 years ago, LA County developed a transformative plan to re-envision the river as an 'Urban Treasure' and a 'valuable natural asset' that would enrich the quality of life for residents and help to sustain the economy of the region.<sup>2</sup> Since publication, miles of trails have been added for pedestrians and cyclists, and the river has emerged as an iconic presence in Angelenos' minds. Today, new concerns have shifted from what was once aspirational into something that brings tangible value and improvement to all communities along the river and those who travel along its banks. The Master Plan assembled today has been constructed from robust data sets that have provided clear metrics for addressing flood risk, water resources, connectivity, and, critically, social health and equity.

Building great projects that meet the goals of the LA River Master Plan is not enough. During project development, the ongoing success of projects must be a significant consideration. Plants sourced locally and grown from plant material that originates from the watershed and ecoregion is best suited and strongly suggested. Generally local native plant ecotypes enhance habitat for local pollinators, insects, birds, mammals, and other wildlife, while preserving the genetic integrity of native plant communities. Topics such as life cycle costs, including operations and maintenance funding and responsibility, must be planned for. Other items that can frequently cause issues after project development if not considered in how elements are designed, such as pest and vector control, should be addressed during the design phases. Additional stressors on long-term success may be related to the use of the LA River right-of-way by persons experiencing homelessness. Thinking through all of these elements during the design process is required.

## LIFE CYCLE COSTS AND O&M

The LA River flows through various cross-sectional conditions along its 51-mile course including concrete lined and earthen reaches as well as trapezoidal and rectangular section reaches. The typical river right-of-way includes flood management structures such as levees, the channel itself as well as access roads, and various recreational amenities such as bike paths and trails, which are primarily maintained by the United States Army Corps of Engineers (USACE) and the Los Angeles County Flood Control District (LACFCD). In some cases, other entities such as municipalities, non-governmental agencies, or developers provide O&M of the various recreational and habitat amenities.

Maintenance costs must be considered and planned for during project development to determine responsibility for funding the day-to-day operations and maintenance of projects. The responsible agency for maintenance of projects and improvements must be identified for any projects in the LA County Flood Control District right-of-way to receive a permit.

Every project permitted under these guidelines requires the submission of a three year maintenance and monitoring plan for the site along with the expected budget for the maintenance. The agency responsible for maintenance must agree in writing to the maintenance plan and budget. See the permitting checklist (on page 34) for full maintenance plan requirements.

In addition to day-to-day maintenance costs, the long-term needs for rebuilding and repairing projects should be considered by the responsible agency to ensure success. Upon completion of a project, operations and maintenance alone may average 0.1-1% of the capital costs annually depending on the type of project and facility. Replacement costs are in addition to these numbers. Significant replacement of infrastructure, such as levees and floodwalls, while required much less frequently, can be a significant life cycle cost.

**THE MASTER PLAN HAS BEEN CONSTRUCTED FROM ROBUST DATA SETS THAT HAVE PROVIDED CLEAR METRICS FOR ADDRESSING FLOOD RISK, WATER RESOURCES, CONNECTIVITY, AND, CRITICALLY, SOCIAL HEALTH AND EQUITY**

---

## **PERSONS EXPERIENCING HOMELESSNESS**

Los Angeles has one of the largest populations of persons experiencing homelessness in the United States, and many of the county's unsheltered residents take refuge within the LA River right-of-way. The presence of homeless encampments can impede operations and maintenance efforts along the river, exacerbate pollution, and discourage recreational users from visiting the river. Those living in encampments also face chronic health risks due, in great part, to a lack of access to sanitation and hygiene facilities. The ongoing success of projects along the LA River largely depends on how communities experiencing homelessness dwelling on the river banks or in the channel are addressed—with such, it is critical that river improvements do not result in spaces of exclusion. Rather, what is needed is an overarching commitment to provide opportunities for sanitation and personal hygiene that are both accessible and humane. The construction and maintenance of pavilions where one can use the restroom, wash their hands, take a shower, and dispose of trash will have a resoundingly positive impact on the health, dignity, and general well-being of all people along the river, as well as the health and safety of the river itself.

Likewise, the LA River should be an environment that reflects active care. The maintenance of clear sight lines is equally critical for both safety and comfort, as they prevent visual isolation and enable “eyes on the street” (in this case, “eyes on the river”). Street furniture provides an essential place to rest, and the design of common elements like seating should be varied enough to allow for different types of uses. To endure as a public space that truly serves all, including persons experiencing homelessness, the LA River should incorporate a multiplicity of facilities, large and small, that ensure safety, provide comfort, amplify beauty, and encourage the coexistence of diverse populations.

## **PEST/VECTOR CONTROL**

At the beginning of project development, it is critical to review design ideas with the vector control district of jurisdiction to ensure proper mosquito minimization measures are incorporated into the project. Mosquitoes threaten public health by transmitting a number of potentially debilitating, even fatal, diseases. Mosquito minimization measures should include natural predation, mosquito exclusion, and a comprehensive operation and maintenance plan including vegetation management. The system should be designed to facilitate necessary surveillance as well as physical and chemical mosquito control efforts by the vector control agency. A checklist developed by the California Department of Public Health entitled “Checklist for Minimizing Vector Production in Stormwater Management Structures” is available to assist designers, <https://www.cdph.ca.gov/>.

The project should be designed to facilitate necessary surveillance as well as physical and chemical mosquito control efforts by the vector control agency. Projects that fail to incorporate proper mosquito minimization will be subject to costly corrective actions including potential abatement proceedings pursuant to the California Health and Safety Code Section 2000-2007.

# PERMITTING

Depending on the project type, location, and site-specific conditions, there are many permit requirements to meet in order to plan and develop a project along the LA River.

The most common types of approvals and permits required for projects along the LA River are included below to assist in project development, but project teams should always review the latest information available from each agency at the time of project planning to confirm requirements.

Projects that require discretionary approval (meaning the approval requires the exercise of judgment or deliberation by the reviewing public agency or agencies prior to approving or disapproving a project) require some level of environmental review pursuant to the California Environmental Quality Act (CEQA). Projects that also impact a federal facility, such as the LA River Channel itself, are also subject to the National Environmental Policy Act (NEPA).

Proponents of projects in and along the LA River corridor may also need to consider and plan for:

- Site access through acquisition or easement.
- Municipal permits such as Building and Safety and/or permits for work within the public right-of-way.
- Coordination with rail corridors as much of the river corridor is flanked by rail (South California Regional Rail Authority, Metropolitan Transit Authority, Union Pacific Railroad, etc.).
- Utilities, including connections/hook ups, crossings, relocations.
- Site remediation, including clean up of toxic soils, may require coordination with the Environmental Protection Agency, California Environmental Protection Agency, or Department of Toxic Substances Control.

In addition to the above, there is a consistent suite of permits that may be required for projects in and along the LA River Corridor.

## LA COUNTY FLOOD CONTROL DISTRICT (LACFCD) (FCD PERMITS ARE ISSUED BY LA COUNTY PUBLIC WORKS)

A Flood Control Permit is required where the LACFCD owns the land or controls the operations and maintenance of the LA River Corridor, to ensure that the proposed project does not interfere with the LACFCD's operation and maintenance responsibilities. Some of the more common types of Flood Control Permits are:

**Access Permit:** required for temporary use of LACFCD right-of-way. Examples include community or educational events, volunteer trash cleanup events, or filming.<sup>3</sup>

**Connection Permit:** required when a private citizen, developer, or agency proposes to connect a drainage system to an existing LACFCD facility. Examples include connecting a small pipe to the rear of a catch basin or a new storm drain connecting to a larger storm drain or channel.<sup>4</sup>

**Temporary Discharge Permit:** required for the temporary discharge of non-stormwater such as water well start up, construction dewatering, municipal water supply system flushing, swimming pool discharge etc.<sup>5</sup>

**Construction Permit:** required for encroachment onto and/or alteration of LACFCD right-of-way for new construction. A few examples of permitted activities are storm drain realignment, landscape improvements, parks, bikeway construction, or installation of structural best management practice devices.<sup>6</sup>

The LA River Design Guidelines contained within this document must be followed for projects seeking this type of permit. The design of recreational amenities, parks, and plantings for the LA River requires a series of steps and procedures to achieve optimum success, which includes the development of plans and specifications that meet the permit criteria of the LA County Public Works. Project proponents must submit plans for approval by LA County Public Works on a project by project basis. Permittee is responsible for adhering to all requirements. Requirements for jurisdictional reviews and permits procedural issues are outlined in detail on the following pages:



## LA RIVER MAINTENANCE RESPONSIBILITIES



### Agency:

**Los Angeles District,  
US Army Corps of Engineers  
(USACE: 23.5 miles)**

**Los Angeles County Flood  
Control District  
(LACFCD: 27.5 miles)**

Figure 18. LA River Maintenance Responsibilities. Currently, the LA River and its tributaries are operated and maintained by the USACE or the FCD. This map indicates which entity has jurisdiction in different segments of the river. Source: LA County Public Works, GIS Maintenance Map, 2016.

# LACFCD PERMITTING CHECKLIST

## Detailed Checklist for LA County Flood Control District (LACFCD)

- Submit all applicable forms per permit type.

### Background Review

- Determine river mile location of project and list on all documents associated with the project.
- Review the LA River Master Plan documents to identify local and site-specific opportunities.
- Review the LA River Design Guidelines (this document) for applicable requirements.
- Review the LA River Master Plan goals to confirm the project is aligned with long-term actions and methods.
- Determine location of nearest river pavilion and amenities to determine what is required on-site.
- Meet with LA County Public Works staff and local municipality staff (as required per site location).
- Review other relevant documents, such as adjacent city plans.
- Meet with sponsoring groups (as required).
- Begin community engagement process.
- Hire a professional design team (may include landscape architect, engineer, architect, ecologist, artist, botanist, and others depending on project type). (Best Practice: Early integration of all disciplines, particularly designers and artists.)

### Long Term Usage and Maintenance Agreement

- Submit usage agreement or comparable document agreed upon by the project proponent and the Flood Control District that includes ownership information, easement information, and any other applicable memoranda of understanding surrounding the usage of the site and responsible parties for construction, long term maintenance, replacement, and operations of the project.

### Evaluate Site for Opportunities and Constraints

- Determine maintenance jurisdiction.
- Determine all land ownerships and easements/rights-of-way.
- Contact all agencies involved and owners for concept approval.
- Identify water source (point of connection) if required and funding responsibility.
- Conduct site analysis:
  - Assess topographic, hydrologic, and microclimate conditions.
  - Conduct agronomic and biological activity soil test.
  - Determine existing utilities (gas lines, water lines, electric lines).
  - Review applicable codes, which may include, but is not limited to CA Title 24 Building Energy Efficiency Standards, LA County Public Works and/or American Public Works Association (APWA) Standard Plans, LA County Flood Control District Code, Municipal Codes, USACE Policy, LID Ordinance and Manual, LA County Parks and Rec Guidelines.
- Research adjacent arts and cultural assets determine if project should have an art component.

### Conceptual Design Stage

- Develop a site-specific program (include multi-benefit opportunities as outlined in the LA River Master Plan Kit of Parts).
- Develop preliminary plant palettes per the Design Guidelines starting on page 218.
- Develop conceptual planting and grading.
- Develop conceptual public art program (as required).



- Prepare section-view illustrations, including topography, planting, and architectural features.
- Identify irrigation basis of design.
- Submit to LA County Public Works for review.
- Discuss applicability of plant nursery contract growing for the project.
- Review O&M requirements for project success and begin to plan for how O&M will be accomplished.

### **Schematic Design Stage**

- Prepare design and irrigation plans with preliminary details.
- Consult LA County LID manual and municipality requirements regarding irrigation equipment.
- Prepare comprehensive plant palettes including species types, quantities, sizes, and installation details.
- Begin contract growing process (as required).
- Prepare preliminary cost estimate and project specifications.
- Complete preliminary site engineering analyses as required for project including stormwater calculations, hydraulic analyses, and site structures.
- Prepare public art proposal (as required).

### **Monitoring and Maintenance Program**

- Prepare irrigation schedule.
- Prepare a 12 month maintenance program for planting.
- Prepare a 3 year monitoring and maintenance program, including all planting and improvements (pavilions, site furnishings, etc). See pages 96-97, 156-157, 302-305, and 348-349 for technical drawing and specific requirements for trails, environmental graphics, planting, and site amenities.
- Submit budget for maintenance, and include a written statement of intention to perform and fund maintenance.
- List agencies responsible for maintaining the project.
- Prepare O&M for public art proposal (as required).

### **Technical Drawings and Specifications**

- Coordinate technical drawings with public art (as required).
- Submit technical drawings and specifications to the county for review and approval. Landscape plans, irrigation plans, and specifications to be prepared by a registered landscape architect licensed to practice in California. Engineering plans, calculations, and specifications to be prepared by a California registered engineer. For structural amenities not shown in the county or APWA standard plans, the designer should provide detailed drawings and design calculations, prepared, signed, and stamped by a California registered civil or structural engineer. See pages 96-97, 156-157, 302-305, and 348-349 for technical drawing and specific requirements for trails, environmental graphics, planting, and site amenities.
- Submit maintenance and monitoring programs for both 12-month and 3-years as part of the technical specifications required for project approval.
- Require underground service alert (Sponsored by the Underground Service Alert of Southern California, a non-profit mutual-benefit organization dedicated to ensuring public safety and that of workers of underground utility lines: [www.digalert.org](http://www.digalert.org)).

### **As-Built Drawings**

- Submit an updated planting plan, irrigation schematics, site engineering plans, and other applicable as-built record drawings to LA County Public Works. (As built drawings should be prepared by the installing contractor.)

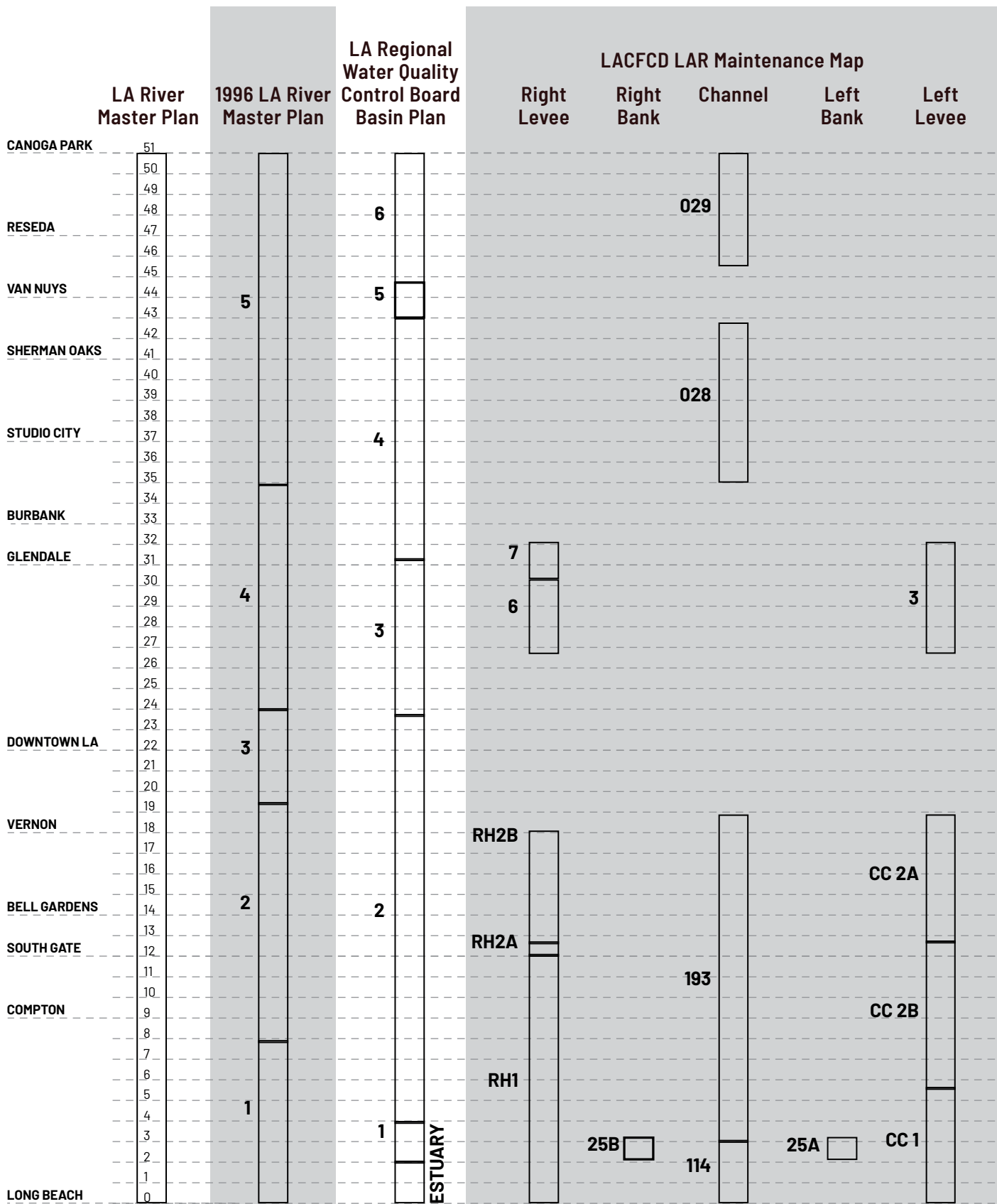


Figure 19. Various governmental entities use differing methods to define river segments, as shown in this diagram. However, all projects permitted under these guidelines are required to reference the 51 mile LA River numbering system. This diagram is for reference only. Other entities may change their definitions over time, so consult with the applicable entity as needed. Source: LA River Master Plan, 2020.

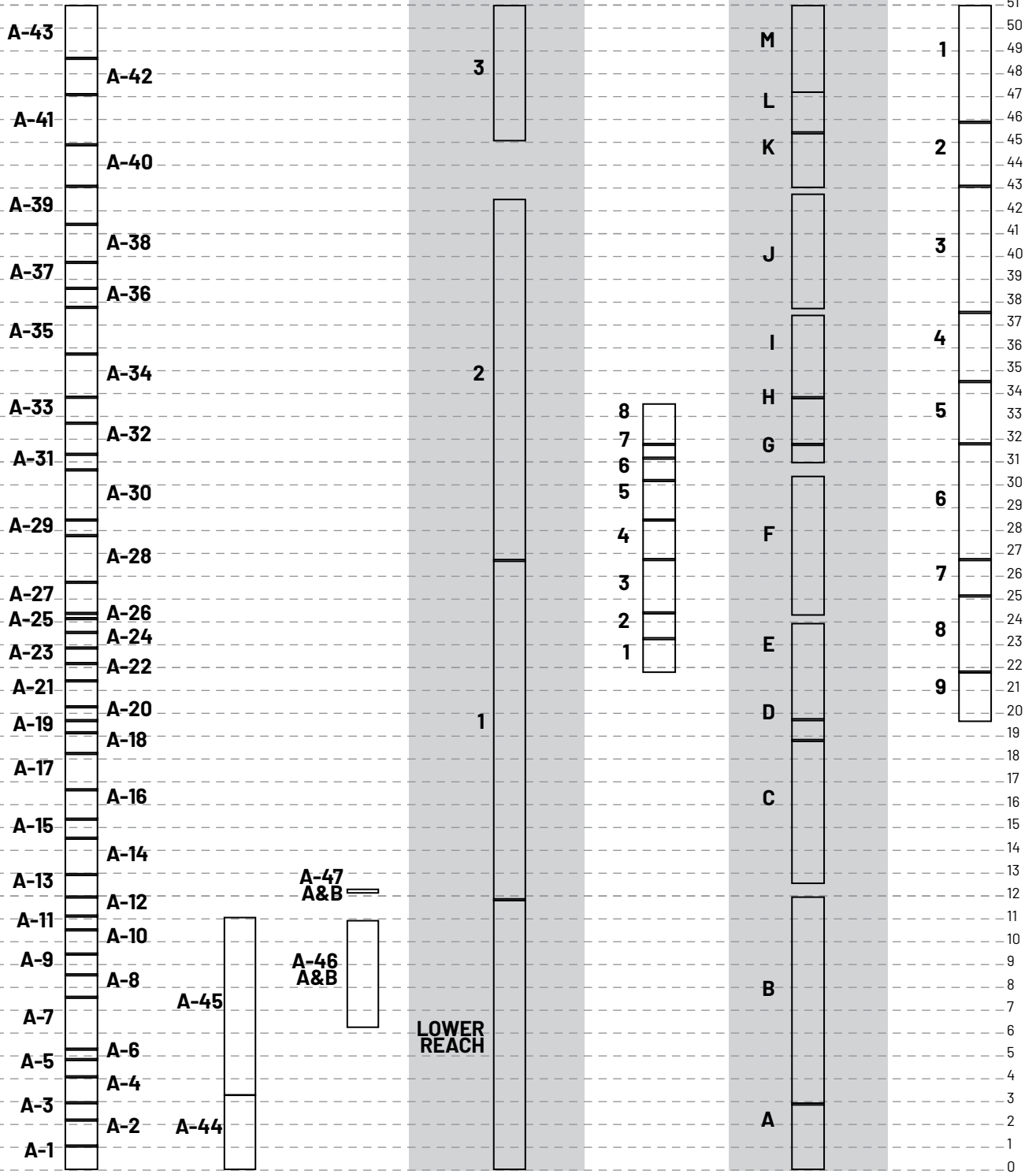
USACE LA County Drainage Area  
Operation, Maintenance, Repair,  
Replacement and Rehabilitation Manual

USACE  
HEC-RAS Model

USACE  
ARBOR Study

LA River  
Integrated  
Design

LA River  
Revitalization  
Master Plan



LA River  
Miles



# OTHER PERMITS

## US ARMY CORPS OF ENGINEERS (USACE) LOS ANGELES DISTRICT

**404:** Section 404 of the Clean Water Act (CWA) establishes a program to regulate the discharge of dredged or fill material into waters of the United States (WOUS), including wetlands. Activities in waters of the United States regulated under this program include the construction, modification, or removal of structures and work involving dredging, disposal of dredged material, filling, excavation, or other modification to a WOUS. Proposed activities that modify a WOUS are regulated through a USACE permit review process. The USACE issues both individual and two types of general permits; including nationwide and regional permits that are required before dredged or fill material may be discharged into WOUS. General permits provide a more streamlined application and expedited review process and are applicable for work that is typically more common in nature (e.g., outfall structures) and generally minimal in nature. An individual permit is generally required for more complex projects or projects that may potentially result in significant impacts. Individual permits require a public review and compliance with CWA Section 404(b)(1) Guidelines, promulgated by the Environmental Protection Agency<sup>7</sup> including completion of an alternative's analysis. Both individual and general permit applications need to demonstrate that steps have been taken to avoid impacts to wetlands, streams and other aquatic resources; that potential impacts have been minimized; and that compensation will be provided for all remaining unavoidable impacts.<sup>8</sup> Projects requiring individual permits also need to demonstrate that the Least Environmentally Damaging Practicable Alternative (LEDPA) is selected.

**408:** USACE, in partnership with local partners, has constructed many Civil Works projects across the nation's landscape, including the LA River. Over time, there may be a need for others outside of the USACE to alter or occupy these projects and their associated lands. In order to ensure that these projects continue to provide their intended benefits to the public, Congress mandated that any use or alteration of a Civil Works project by another party is subject to the approval of USACE. This requirement was established in Section 14 of the Rivers and Harbors Act of 1899 and codified

in 33 USC 408, commonly referred to as "Section 408." USACE Section 408 policy, contained in the document Engineer Circular (EC) 1165-2-220 effective September 10, 2018, sets forth the process and criteria USACE uses to review requests to alter USACE Civil Works projects.<sup>9</sup>

## US FISH AND WILDLIFE SERVICE (USFWS)

The USFWS reviews and comments on projects pursuant to the Fish and Wildlife Coordination Act, the CWA, and the NEPA. The USFWS's comments focus on the effects of projects on all fish and wildlife resources and the habitats that support those resources. Such projects may be, but not limited to, flood risk management, urban and industrial development, habitat restoration activities, etc. The USFWS also reviews projects for their affects pursuant to the Federal Endangered Species Act (ESA). The ESA, through Section 9, prohibits the take of any species listed as threatened or endangered pursuant to the Act. The USFWS is responsible for issuing permits authorizing the incidental take of threatened or endangered species that is consistent with conservation of that species and exempts the take from the Section 9 prohibitions. When projects or activities require a federal permit, such as a CWA section 404 permit from USACE, Section 7 ESA consultation with USFWS is required. The consultation typically starts as informal consultation during the planning stage. If the informal consultation identifies the proposed project is not likely to affect listed species, consultation between the USACE and the USFWS is considered complete. If listed species may be affected the USACE will request formal consultation with the USFWS, and the USFWS will prepare a biological opinion outlining if the proposed development is likely to adversely affect or take of a listed species. If identified reasonable and prudent alternatives still result in adverse effects or take of a listed species, the USFWS will prepare an incidental take statement that outlines project conditions and exempts the take from the Section 9 prohibitions. If there is no Federal involvement, and the project may result in an incidental take, Section 10 requires a Habitat Conservation Plan (HCP) be prepared as part of an application to obtain an incidental take permit from the USFWS. Similar to the incidental take statement, the incidental take permit exempts the take from Section 9 prohibitions.<sup>10</sup>

## **NATIONAL MARINE FISHERIES SERVICE (NMFS)**

This is the federal agency responsible for the conservation and management of the nation's living marine resources. Projects or activities that may affect marine fish and related habitat within NMFS jurisdiction are reviewed for any potentially harmful effects. These evaluations are conducted under the authority of the ESA, Magnuson-Stevens Fishery Conservation and Management Act, Fish and Wildlife Coordination Act, and NEPA. The purpose of the reviews conducted by NMFS is to ensure that sensitive populations of marine and anadromous fish (such as salmon and steelhead), as well as the aquatic and riparian habitats that support these fish, can survive and recover in the presence of human activities. Through these reviews, the need to conserve and protect fish and habitat is balanced with the need to responsibly utilize natural resources for economic and other purposes. When projects or activities require a federal permit, such as a CWA section 404 permit from USACE, Section 7 ESA consultation with the NMFS, in addition to the USFWS, may be required if applicable. If there is no Federal involvement, and the project may result in an incidental take, Section 10 requires a HCP be prepared and an incidental take permit be obtained through the NMFS, in addition to the USFWS, if applicable.<sup>11</sup>

## **CALIFORNIA DEPARTMENT OF FISH AND WILDLIFE (CDFW)**

**1602:** The Fish and Game Code section 1602 requires any person, state, or local government agency, or public utility to notify the CDWF before beginning any activity that will:

- Substantially divert or obstruct the natural flow of any river, stream or lake; or
- Substantially change or use any material from the bed, channel, or bank of any river, stream or lake; or
- Deposit or dispose of debris, waste, or other material containing crumbled, flaked, or ground pavement where it may pass into any river, stream, or lake.

If CDFW determines that the activity may substantially adversely affect fish and wildlife resources, a Lake or Streambed Alteration (LSA) Agreement will be required that is compliant with CEQA.<sup>12</sup>

## **CALIFORNIA COASTAL COMMISSION**

**Coastal Development Permit:** The California Coastal Act of 1976 requires any person proposing to undertake development in the Coastal Zone to obtain a Coastal Development Permit. The Coastal Zone extends inland anywhere from approximately 500 yards in developed urban areas to five miles in undeveloped areas. If projects are proposed in or adjacent to existing or historic coastal wetland areas, they will require Coastal Development Permits issued by the Coastal Commission.<sup>13</sup> The Coastal Act defines development broadly (with a few narrow exceptions), to include not only typical land development activities such as construction of buildings, but also changes in the intensity of use of land or water, even where no construction is involved. Coastal Development Permits are the regulatory mechanism by which proposed developments in the coastal zone are brought into compliance with the coastal resources planning and management policies of Chapter 3 of the Coastal Act.<sup>14</sup>

## **LOS ANGELES REGIONAL WATER QUALITY CONTROL BOARD**

**401:** Section 401 of the CWA requires that any person applying for a federal permit or license which may result in a discharge of pollutants into WOUS must obtain a state water quality certification that the activity complies with all applicable water quality standards, limitations, and restrictions. No license or permit may be issued by a federal agency until certification required under Section 401 has been granted.<sup>15</sup> Meaning, that before the Corps can issue a 404 permit, a 401 permit must be obtained from the Los Angeles Regional Water Quality Control Board (LA RWQCB).



## PLANNING FRAMES

A series of nine geographical frames assists in understanding where specific site opportunities are located in relation to municipal, hydraulic, and ecological zones. There is no single design solution that is applicable to all 51 miles of the LA River; therefore, it is critical to understand where a site is located in the larger context of the river as well as its local context. The frames allow river champions to take responsibility for specific sections of the Master Plan implementation and work together to bring them into reality.

The nine frames are divided as follows:

**Frame 9 - West Valley:** City of Los Angeles; river mile 51.0 - 43.1

**Frame 8 - Mid Valley:** City of Los Angeles; river mile 43.1 - 37.8

**Frame 7 - East Valley:** Cities of Los Angeles, Burbank; river mile 37.8 - 32.0

**Frame 6 - Narrows:** Cities of Los Angeles, Burbank, Glendale;  
river mile 32.0 - 24.5

**Frame 5 - Heights:** City of Los Angeles; river mile 24.5 - 19.5

**Frame 4 - North Plain:** Cities of Bell Gardens, Bell, Maywood, Vernon,  
Commerce; river mile 19.5 - 14.14

**Frame 3 - Central Plain:** Cities of Compton, Paramount, Downey, Lynwood,  
South Gate, Cudahy; river mile 14.14 - 8.4

**Frame 2 - South Plain:** City of Long Beach; river mile 8.4 - 4.0

**Frame 1 - Estuary:** City of Long Beach; river mile 4.0 - 0.0



# LA RIVER PLANNING FRAMES

- 9** Frame 9 - West Valley
- 8** Frame 8 - Mid Valley
- 7** Frame 7 - East Valley
- 6** Frame 6 - Narrows
- 5** Frame 5 - Heights
- 4** Frame 4 - North Plain
- 3** Frame 3 - Central Plain
- 2** Frame 2 - South Plain
- 1** Frame 1 - Estuary

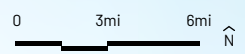


Figure 20. LA River Planning Frames.

# FRAME 9: WEST VALLEY

**Location:** City of Los Angeles (West Hills, Canoga Park, Winnetka, Woodland Hills, Reseda, Tarzana, Lake Balboa, Encino, Sepulveda Basin); river mile 51 - 43.1

**Channel Characteristics:** The channel in this frame begins (at river mile 43.1) as a soft bottom with riparian edges at Sepulveda Basin, and transitions to entrenched trapezoidal concrete channel at mile 45.5. with a typical width of 180 feet. At mile 51, the channel transitions to an entrenched concrete box channel with a typical width of approximately 60 feet.

**Average Channel Slope:** 0.2%

**Landside Right-of-Way Characteristics:** In this frame, the landside right-of-way ranges from 20-30 feet with a few larger tracts in the western portion of Canoga Park that are closer to 40-50 feet in width. The eastern soft bottom portion of the river channel has no landside right-of-way in Sepulveda Basin for approximately two miles (about 25% of the frame).

## Notable Features:

- Dense residential context
- Bell Creek confluence at river mile 51 - also the location of Canoga Park High School
- Browns Canyon Wash confluence at river mile 49.8
- Aliso Canyon Wash confluence at river mile 47.3
- Reseda Park from river mile 46.6 to 47.0 along the right bank
- Sepulveda Basin Recreation Area and Wildlife Reserve from river mile 43.1 to 45.5; a significant ecological area

## Significant Design Considerations for this Frame:

- Mile 51 at the Bell Creek confluence marks the headwaters of the LA River, and projects nearby should consider the significance of this moment of the LA River.
- Projects in this frame have the opportunity to enhance native habitat and connect to other important habitat area in the region, such as the Santa Monica Mountains.
- Sepulveda Basin occurs in this frame, and as a soft-bottomed sediment basin approximately 2,000 acres large, it provides a tremendous opportunity for native habitat and biodiversity.
- Generally surface water in the channel portions of this frame is insignificant, except during rain events.



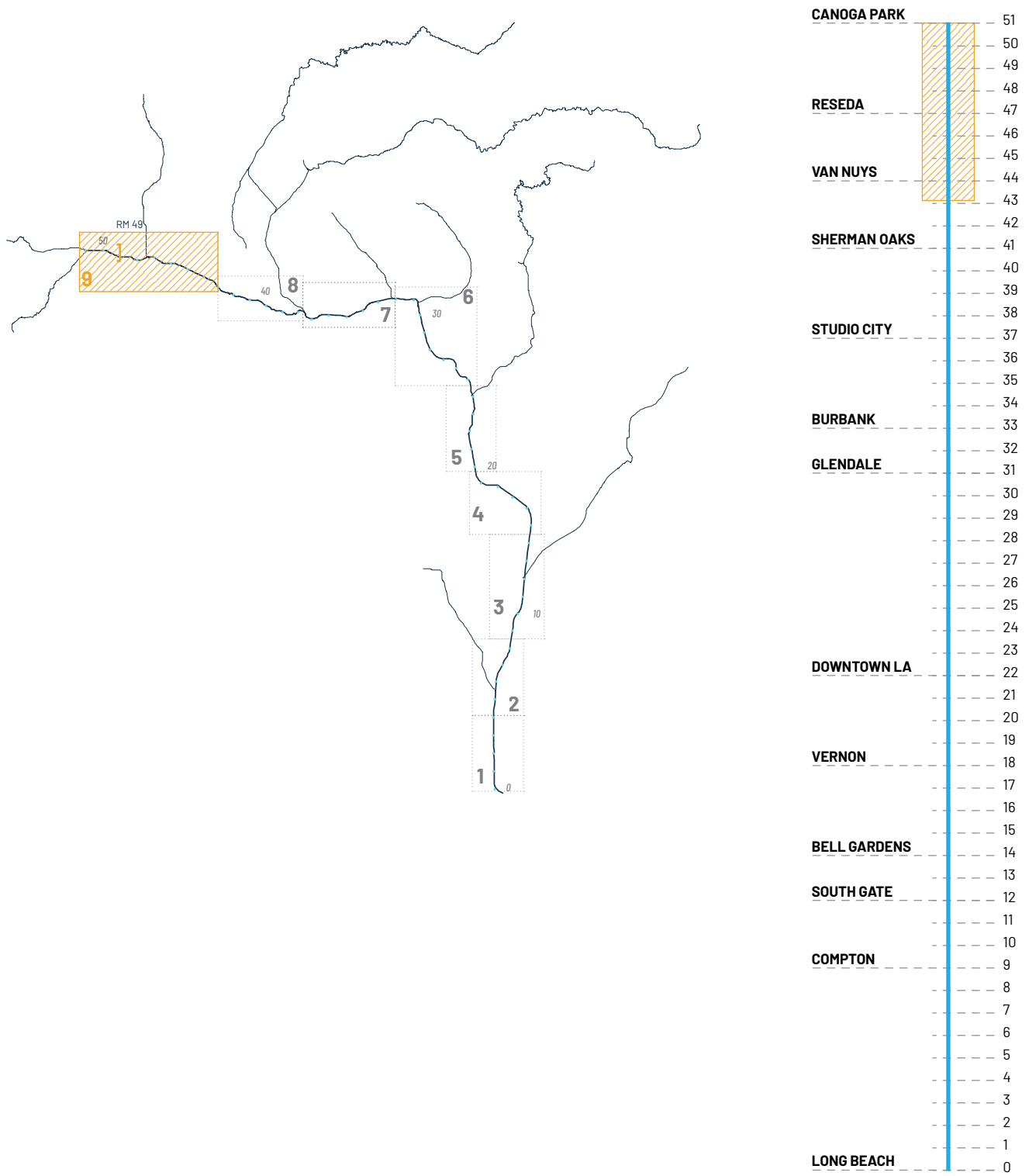


Figure 21. The channel conditions of LA River Planning Frame 9 range from soft bottom to trapezoidal to concrete. Much of the frame occurs in a dense residential context.



# FRAME 8: MID VALLEY

**Location:** City of Los Angeles (Encino, Van Nuys, Sherman Oaks, Studio City, Valley Village, Beverly Crest); river mile 43.1 - 37.8

**Channel Characteristics:** In this frame, the channel is an entrenched rectangular box concrete channel with a typical width of 60 feet.

**Average Channel Slope:** 0.3%

**Landside Right-of-Way Characteristics:** In this frame, the landside right-of-way ranges from 30-60 feet before terminating at the northwestern edge of the frame where Sepulveda Basin begins.

## Notable Features:

- Dense residential context
- Several greenways, from river mile 37.8 to 38.6 along the right bank, from river mile 38.7 to 39.1 along the left bank, and from river mile 39.2 to 39.7 along both the left and right banks

## Significant Design Considerations for this Frame:

- The sections of the frame with a narrower right-of-way may require using the width of the channel or external land acquisition for projects of larger impact.
- Multiuse trails and access for wildlife should both be accommodated, even in tighter right-of-way space. Methods such as habitat ramps into the channel may be considered.
- Connections for wildlife could also be made to the multiple creeks of the Santa Monica Mountains in this area.



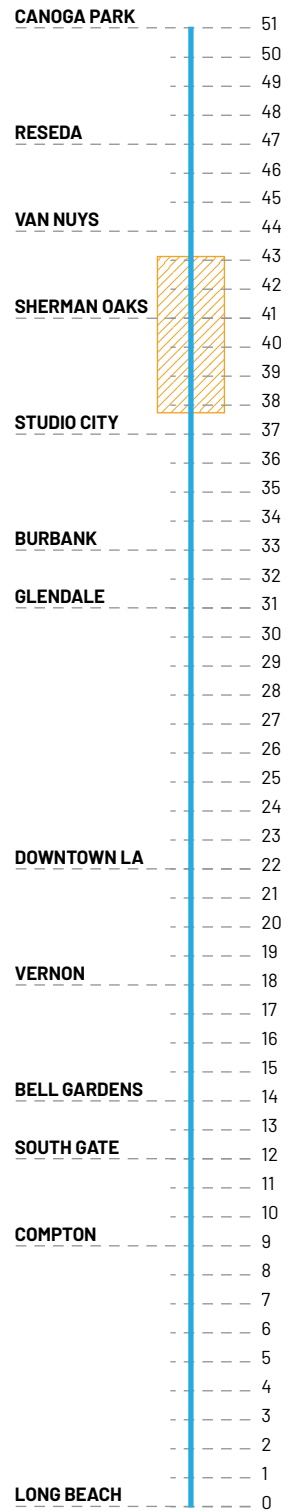
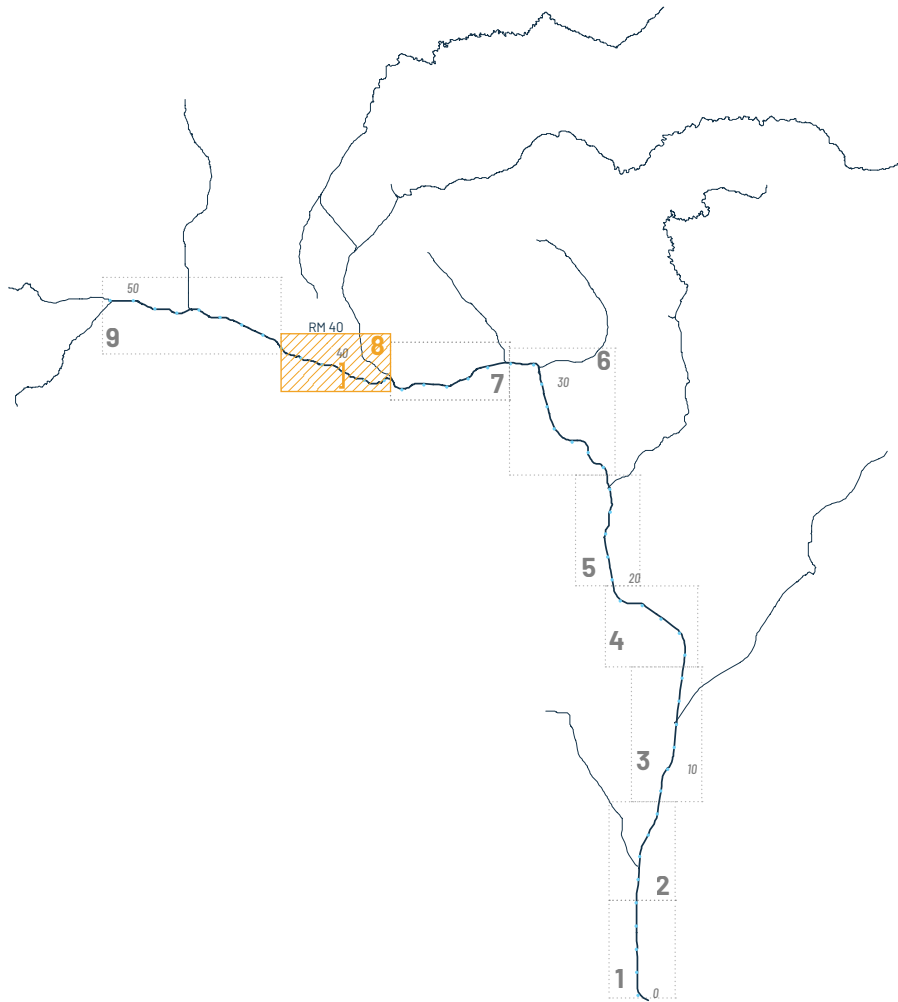


Figure 22. LA River Planning Frame 8 occurs in a dense urban and residential context and the river has a narrow, rectangular box channel section.

# FRAME 7: EAST VALLEY

**Location:** Cities of Los Angeles (Studio City, Valley Village, North Hollywood, Toluca Lake, Hollywood Hills West, Hollywood Hills, Griffith Park) and Burbank; river mile 37.8 – 32.0

**Channel Characteristics:** The channel in this frame is an entrenched rectangular box concrete channel, with a typical width of approximately 130 feet.

**Average Channel Slope:** 0.6%

**Landside Right-of-Way Characteristics:** As the channel narrows in Frame 7, landside right-of-way (ROW) increases to 30-50 feet with a couple of large parcels that extend 200-450 feet into adjacent development. However, there is also approximately a mile on each bank (about 20% of the frame) where there is no landside right-of-way due to Warner Brothers and Universal Studios and the Lakeside Golf Course. The landside right-of-way parcels in this frame are both north and south facing, sometimes on slopes.

## Notable Features:

- Dense residential context
- Tujunga Wash confluence at river mile 37.5
- Lakeside Golf Club from river mile 34.6 to 35.6 along the left bank, no ROW
- Warner Bros Studios from approximately river mile 34 to 34.5 along the left bank, no ROW
- Adjacent to Griffith Park from approximately river mile 32 to 34.5 along the right bank
- Sennett Canyon and Creek at river mile 33.5 along the right bank
- Burbank Channel confluence at river mile 32

## Significant Design Considerations for this Frame:

- Projects in this frame have the opportunity to enhance native habitat and connect to other important habitat corridors in the region, especially the riparian to upland connection along the right bank with Griffith Park.
- Significant equestrian community in this area would utilize an expanded network of equestrian trails.
- The sections of the frame with no ROW may require using the width of the channel or external land acquisition for projects of larger impact.





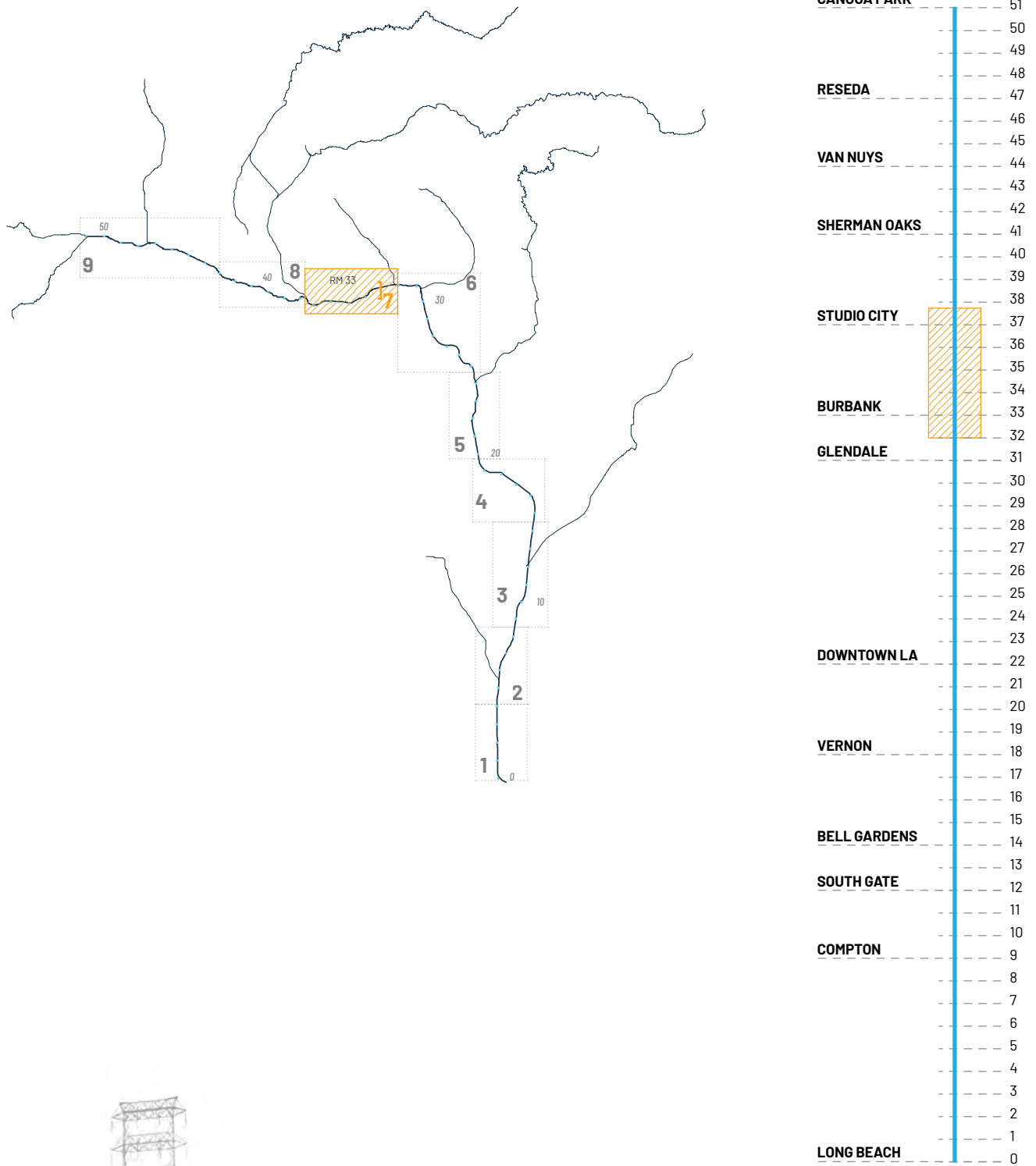


Figure 23. This channel condition of LA River Planning Frame 7 is a rectangular box section. Certain areas of the river have no ROW due to large private land holdings.

# FRAME 6: NARROWS

**Location:** Cities of Los Angeles (Hollywood Hills, Griffith Park, Los Feliz, Atwater Village, Glassell Park, Silver Lake, Elysian Valley, Echo Park, Elysian Park, Cypress Park, Mount Washington, Highland Park, Montecito Heights, Lincoln Heights, Chinatown), Burbank, and Glendale; river mile 32.0 - 24.5

**Channel Characteristics:** In this frame, the channel is primarily soft bottom with entrenched trapezoid concrete walls. Typical channel width is approximately 300 feet. The channel bottom becomes concrete for about a half mile stretch as the river turns a corner just north of the Verdugo Wash confluence.

**Average Channel Slope:** 0.4%

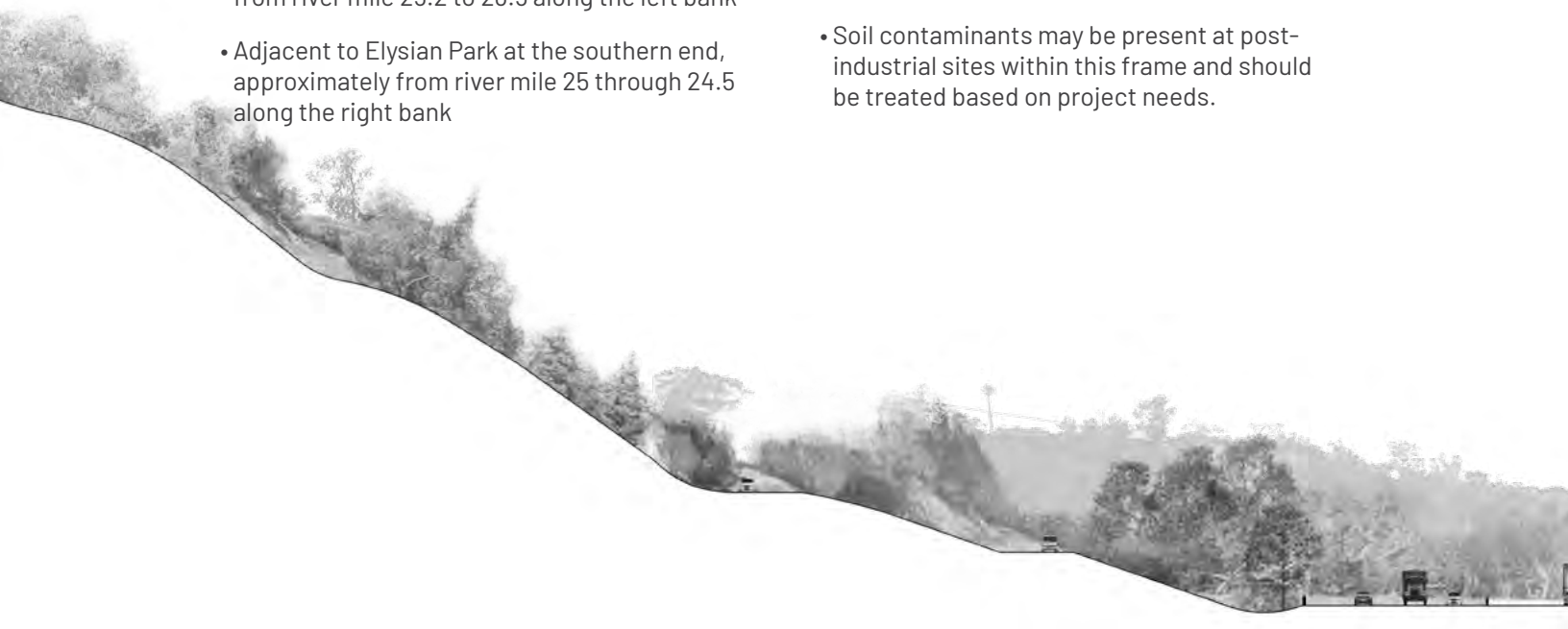
**Landside Right-of-Way Characteristics:** In this frame, the landside right-of-way ranges between 12-30 feet. There are also some gaps in the landside right-of-way along each bank. It consists of northeast and southwest facing parcels.

## Notable Features:

- Significant ecological area with adjacency to Griffith Park from approximately river mile 28.5 through 32 along the right bank
- Barrier between the river and Griffith Park in this frame due to Interstate 5 and the Ventura Freeway
- Heavy sediment and vegetation are present in the channel
- River trail and park improvements
- Verdugo Wash confluence at river mile 30.6 along the left bank
- Rio de Los Angeles State Park and G2 parcel from river mile 25.2 to 26.5 along the left bank
- Adjacent to Elysian Park at the southern end, approximately from river mile 25 through 24.5 along the right bank

## Significant Design Considerations for this Frame:

- Projects in this frame have the opportunity to enhance native habitat and connect to other important habitat corridors in the region (Santa Monica Mountains), although freeway barriers have to be considered in these connections.
- Flooding is a particular concern for residents in this community.
- Significant equestrian community in this area would utilize an expanded network of equestrian trails.
- Surface water is present in the channel bottom of this frame year-round due to a high water table and the underlying geology.
- Soil contaminants may be present at post-industrial sites within this frame and should be treated based on project needs.



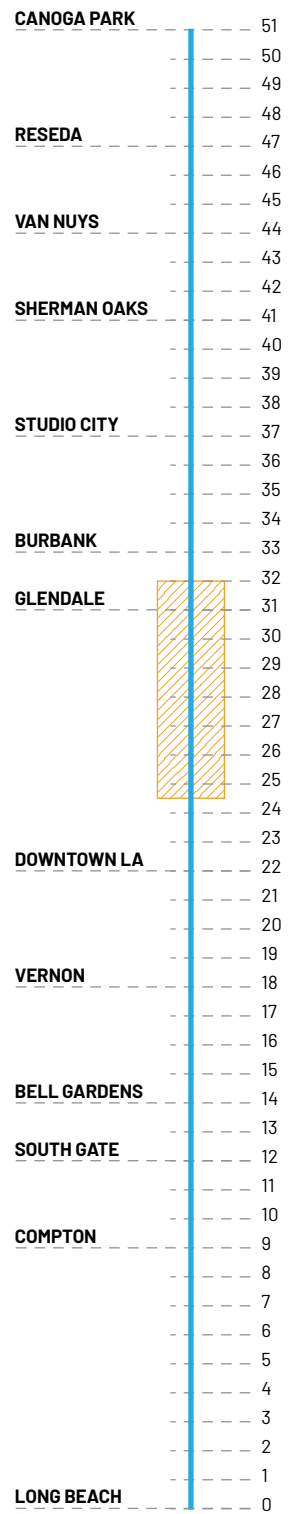
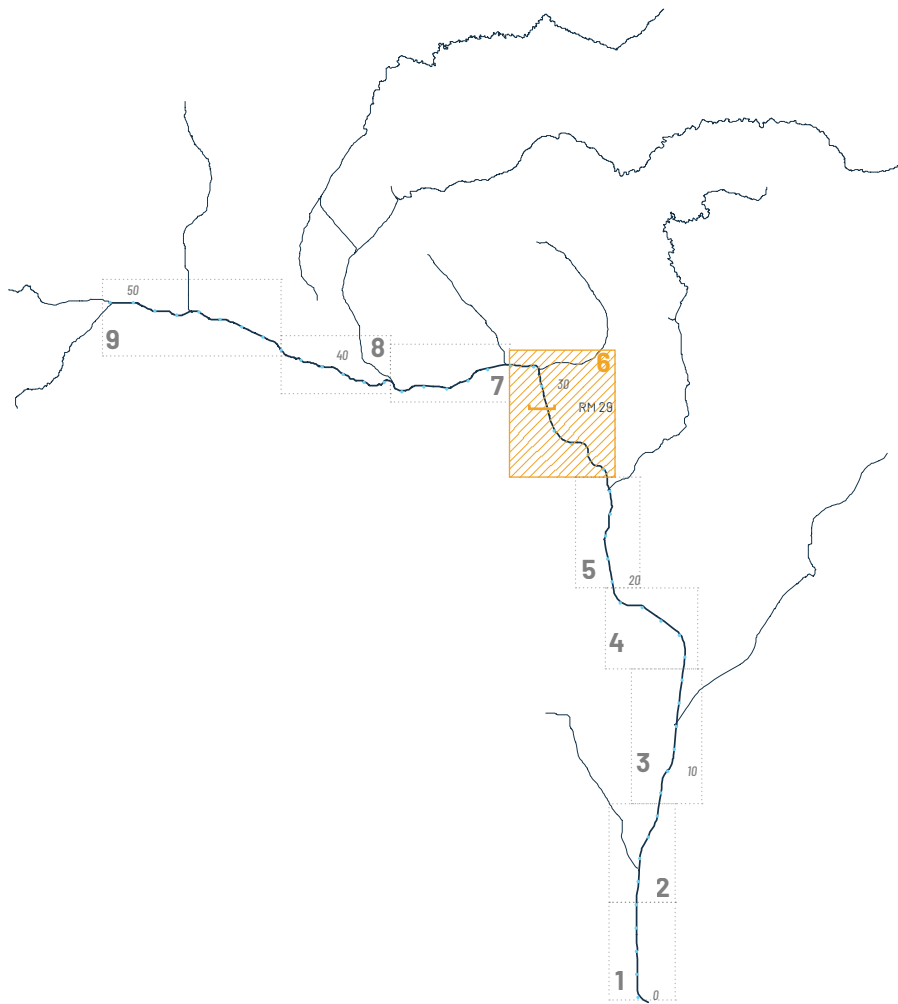


Figure 24. LA River Planning Frame 6 contains soft bottom river profiles and runs adjacent to Griffith Park.



# FRAME 5: HEIGHTS

**Location:** City of Los Angeles (Elysian Valley, Cypress Park, Highland Park, Elysian Park, Chinatown, Lincoln Heights, Montecito Heights, Downtown LA, Boyle Heights, Central Alameda); river mile 24.5 - 19.5

**Channel Characteristics:** The channel in this frame is an entrenched concrete trapezoid section, with a typical width of 225 feet.

**Average Channel Slope:** 0.4%

**Landside Right-of-Way Characteristics:** In this frame, the landside right-of-way is typically less than 12 feet wide, widening at the northern edge. It consists of south, east, and west facing parcels.

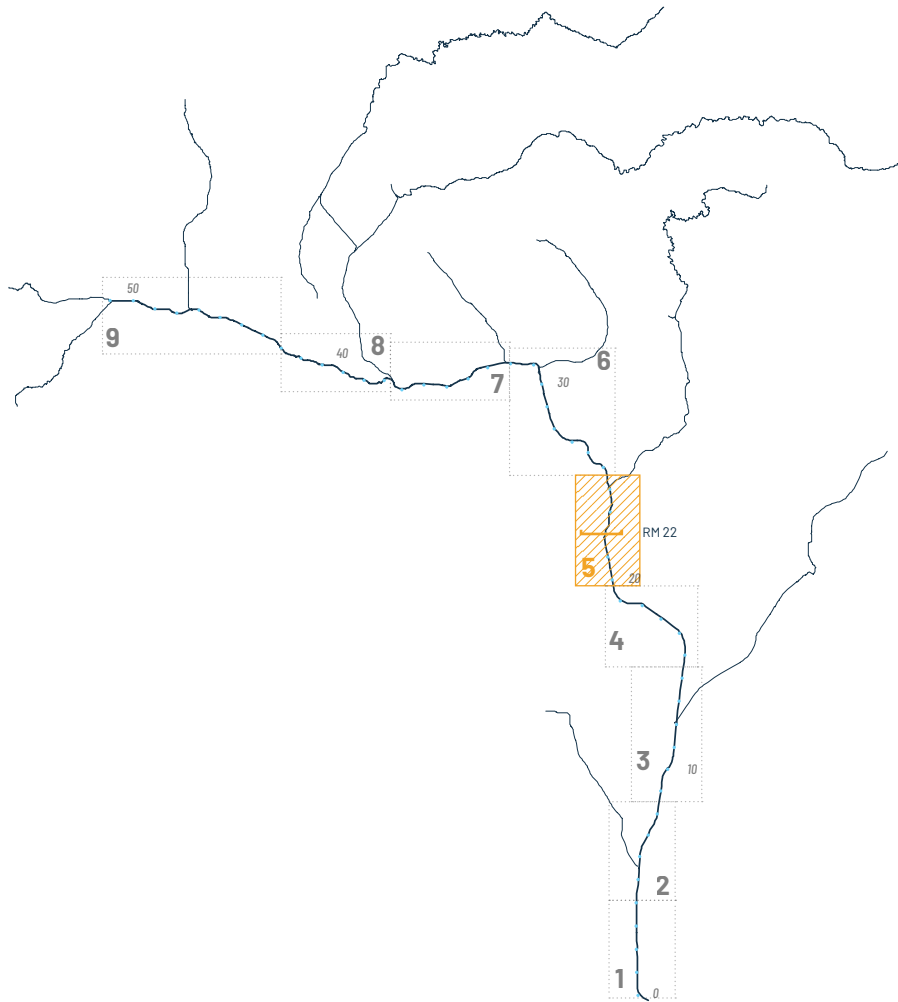
## Notable Features:

- Dense urban context - Downtown Los Angeles adjacent, several notable historic bridges
- High concentration of arts and cultural facilities
- Railroad lines and larger industrial yards along both sides of the river, several former industrial areas
- Los Angeles State Historic Park near river mile 23.5 along the right bank
- Arroyo Seco confluence near river mile 24, where the 110 freeway crosses the LA River

## Significant Design Considerations for this Frame:

- Soil contaminants and air pollution mitigation and treatment are especially important in post-industrial sites prevalent in this frame.
- The often narrow right-of-way may require using the width of the channel or external land acquisition for projects of larger impact.
- Railroads and other transportation networks make it challenging to access the river in this frame.
- Surrounding urban development increases the urban heat island effect, so providing shade is critical.





<b>CANOGA PARK</b>	51
	50
	49
	48
<b>RESEDA</b>	47
	46
	45
<b>VAN NUYS</b>	44
	43
	42
<b>SHERMAN OAKS</b>	41
	40
	39
<b>STUDIO CITY</b>	38
	37
	36
	35
<b>BURBANK</b>	34
	33
	32
<b>GLENDALE</b>	31
	30
	29
	28
	27
	26
	25
	24
	23
<b>DOWNTOWN LA</b>	22
	21
	20
	19
<b>VERNON</b>	18
	17
	16
	15
<b>BELL GARDENS</b>	14
	13
<b>SOUTH GATE</b>	12
	11
	10
<b>COMPTON</b>	9
	8
	7
	6
	5
	4
	3
	2
	1
<b>LONG BEACH</b>	0



Figure 25. LA River Planning Frame 5 includes the section of the river that runs through Downtown LA, often near railroads or industrial sites.

# FRAME 4: NORTH PLAIN

**Location:** Cities of Bell Gardens, Bell, Maywood, Vernon, Commerce, Huntington Park; river mile 19.5 - 14.14

**Channel Characteristics:** The channel in this frame is a concrete leveed trapezoidal section that is approximately 415 feet wide at the southernmost end. It transitions to a concrete entrenched trapezoidal section and then to a concrete entrenched rectangular section at river mile 19 at the northern end, with a width of about 285 feet.

**Average Channel Slope:** 0.2%

**Landside Right-of-Way Characteristics:** In this frame, industrial development and several adjacent rail lines limit the landside right-of-way to consistently less than 15 feet. In the northern portion of the frame, there is no landside right-of-way along the right bank. Right-of-way parcels in this frame are south, east, and west facing.

## Notable Features:

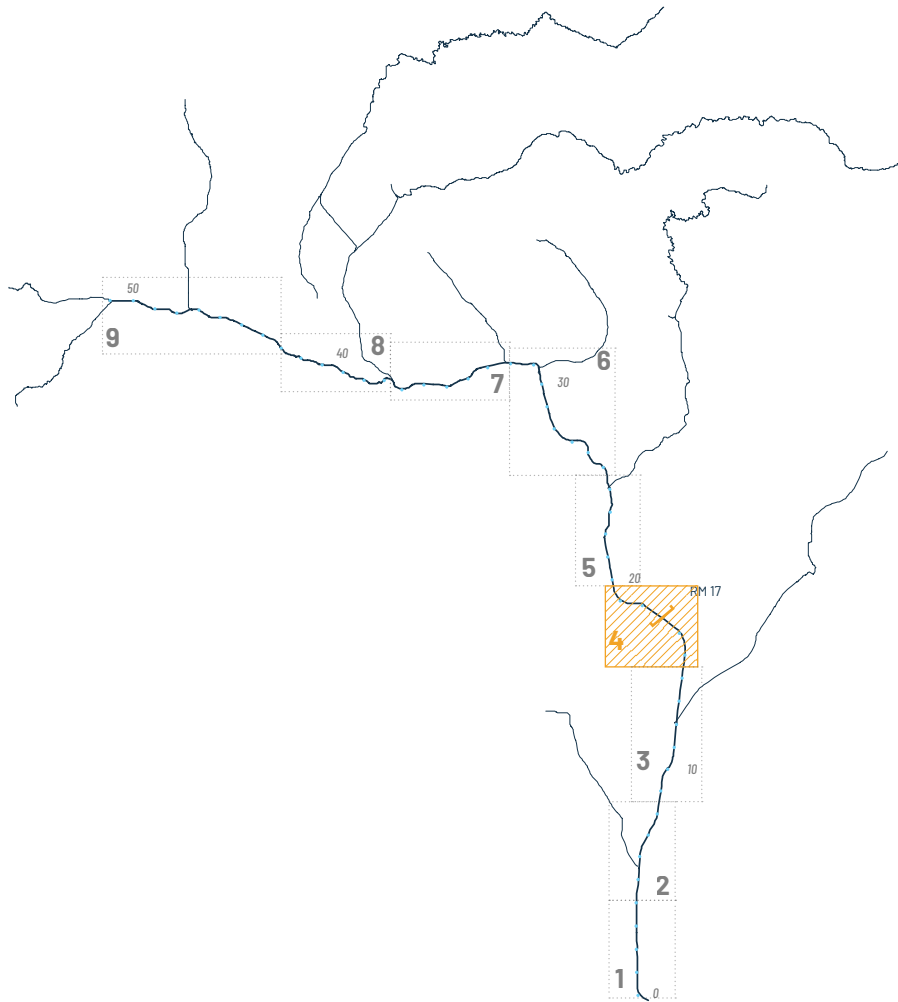
- Dense industrial context
- Pollution and soil contamination present from heavy industry
- Utility rights-of-way and freight yards along both sides of the river
- Maywood Riverfront Park from river mile 15.7 to 15.8 along the right bank

## Significant Design Considerations for this Frame:

- Soil contaminant and air pollution mitigation and treatment are especially important in post-industrial sites prevalent in this frame.
- Utility right-of-way projects require further coordination with power companies, but also provide a significant amount of land for corridor connectivity.
- Very high park needs and industrial land uses limit access to the LA River and healthy open space.
- Access to the river is limited by Interstate 710 so projects may need to consider how barriers to reaching the river can be navigated.







CANOGA PARK	51
	50
	49
	48
RESEDA	47
	46
	45
VAN NUYS	44
	43
	42
SHERMAN OAKS	41
	40
	39
STUDIO CITY	38
	37
	36
	35
BURBANK	34
	33
	32
GLENDALE	31
	30
	29
	28
	27
	26
	25
	24
	23
DOWNTOWN LA	22
	21
	20
VERNON	19
	18
	17
	16
	15
BELL GARDENS	14
	13
SOUTH GATE	12
	11
	10
COMPTON	9
	8
	7
	6
	5
	4
	3
	2
	1
LONG BEACH	0



Figure 26. The river widens to a concrete trapezoidal channel in LA River Planning Frame 4, with many sites that have contamination from adjacent industrial land uses.

# FRAME 3: CENTRAL PLAIN

**Location:** Cities of Compton, Paramount, Downey, Lynwood, South Gate, and Cudahy; river mile 14.14 - 8.4

**Channel Characteristics:** The channel in this frame is a trapezoidal concrete leveed cross section with an approximate width of 400 feet.

**Average Channel Slope:** 0.2%

**Landside Right-of-Way Characteristics:** The landside right-of-way in this frame contains both east and west facing parcels, and is further limited by industrial and residential development, transmission easements, and Interstate 710 and Interstate 105. It exists for extensive lengths at about 15 feet in width. However, there are large 200-foot-wide tracts of the right-of-way incorporated into recreational park space (Ralph C. Dills and Hollydale Parks along with portions of the LA River Trail). There is a dense residential context, east and west facing parcels along levee of varying widths, areas typically 15 feet wide, in addition to utility corridors.

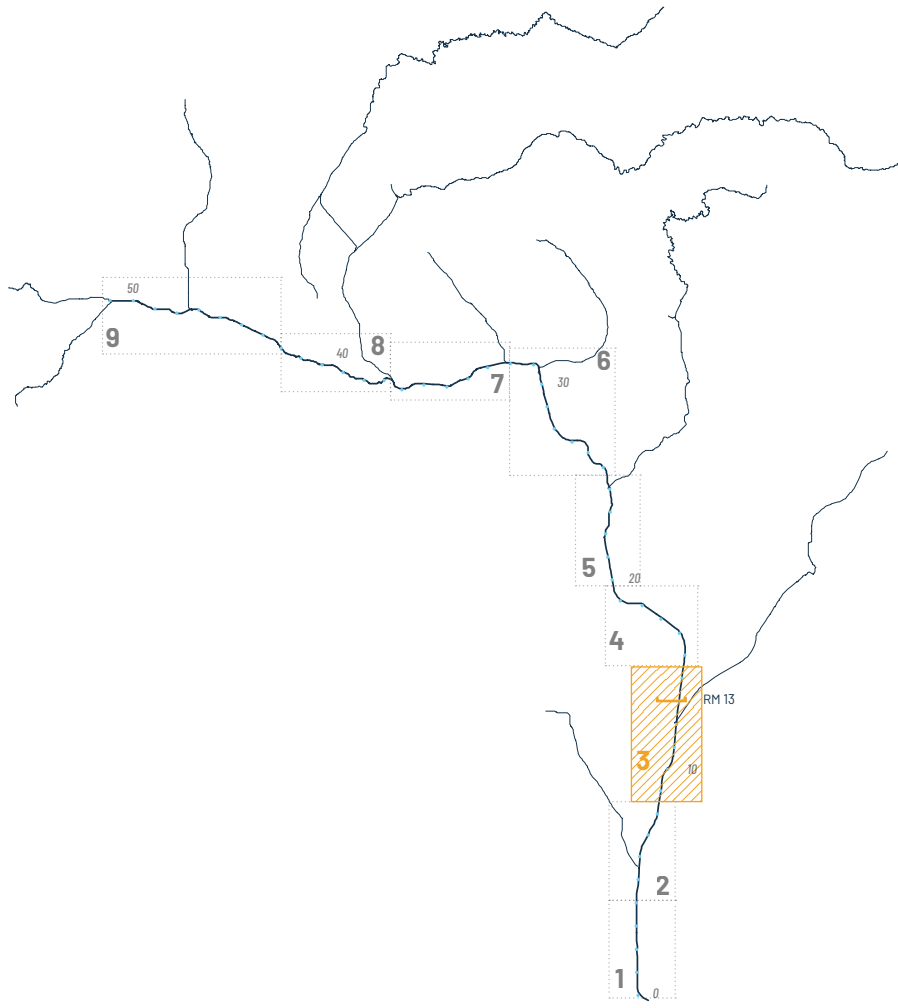
## Notable Features:

- Dense residential context
- Utility ROWs along the left bank of the river
- Rio Hondo confluence at river mile 12.0 along the left bank
- Hollydale Park from river mile 11 to 11.5 along the left bank
- Ralph C. Dills Park from river mile 9.5 to 10.0 along the left bank
- LA River Trail provides recreational opportunities for pedestrians, cyclists, and equestrians

## Significant Design Considerations for this Frame:

- Utility ROW projects require further coordination with power companies, but also provide a significant amount of land for corridor connectivity.





CANOGA PARK	51
	50
	49
	48
RESEDA	47
	46
	45
VAN NUYS	44
	43
	42
SHERMAN OAKS	41
	40
	39
STUDIO CITY	38
	37
	36
	35
BURBANK	34
	33
	32
GLENDALE	31
	30
	29
	28
	27
	26
	25
	24
	23
DOWNTOWN LA	22
	21
	20
	19
VERNON	18
	17
	16
	15
BELL GARDENS	14
	13
SOUTH GATE	12
	11
	10
COMPTON	9
	8
	7
	6
	5
	4
	3
	2
	1
LONG BEACH	0

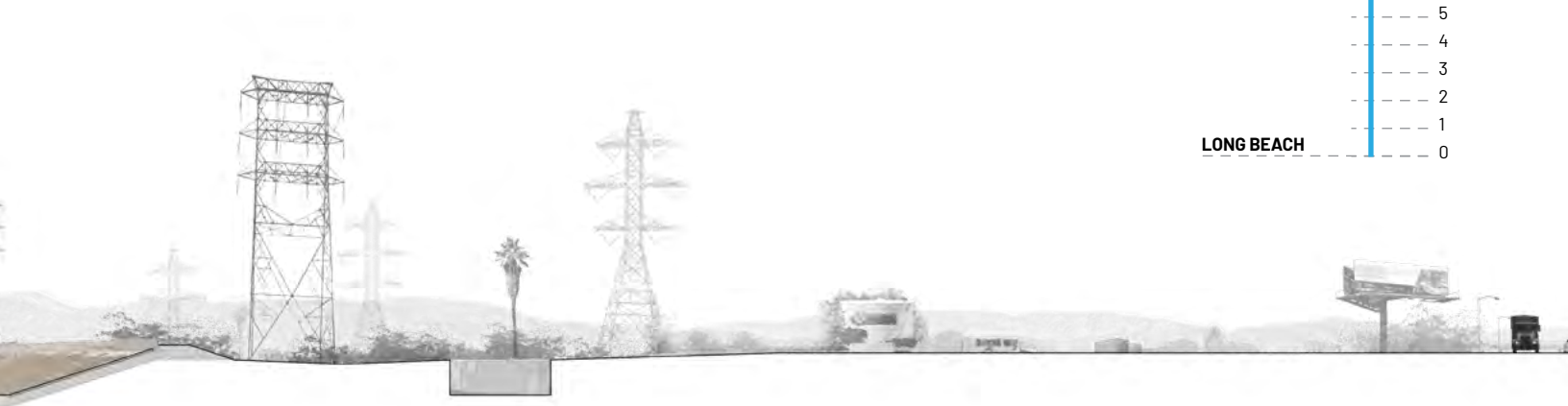


Figure 27. LA River Planning Frame 3 includes the section of the river that runs through South Gate, and often includes power lines from major utilities.

# FRAME 2: SOUTH PLAIN

**Location:** City of Long Beach; river mile 8.4 - 4.0

**Channel Characteristics:** The channel in this frame is a trapezoidal concrete leveed cross section with an approximate width of 350 feet.

**Average Channel Slope:** 0.1%

**Landside Right-of-Way Characteristics:** This frame has some of the widest right-of-way parcels along the LA River. The parcels are east and west facing parcels along the levee. The landside right-of-way is widest in the southern portion of the frame, at widths of over 200 feet on each bank. Industrial and residential development, transmission easements, and Interstate 710 and the 91 Freeway cut into the landside right-of-way in the northern portion of the frame. The landside right-of-way is on average 50 feet wide.

## Notable Features:

- Important bird habitat area
- Freshwater year round
- Utility ROWs along both sides of the river
- De Forest Park from river mile 6.8 to 7.5 along the left bank
- Dominguez Gap Wetlands from river mile 4.8 to 5.8 along the left bank
- Compton Creek confluence at river mile 5.4 along the right bank
- LA River Trail provides recreational opportunities for pedestrians, cyclists, and equestrians

## Significant Design Considerations for this Frame:

- Significant equestrian community in this area would utilize an expanded network of equestrian trails.
- Algae mats on the concrete channel bottom provide an important food source for migrating birds.
- The widest portions of the landside ROW provides opportunity for significant habitat areas.
- Utility ROW projects require further coordination with power companies, but also provide a significant amount of land for corridor connectivity.





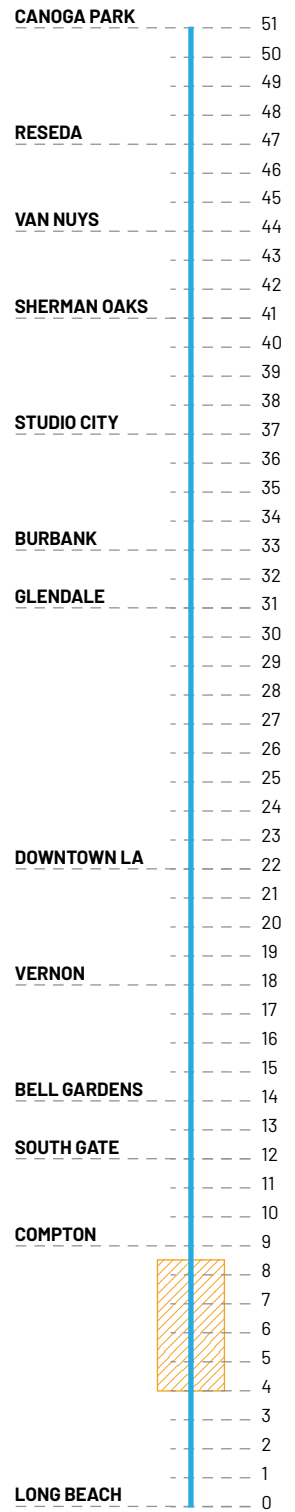
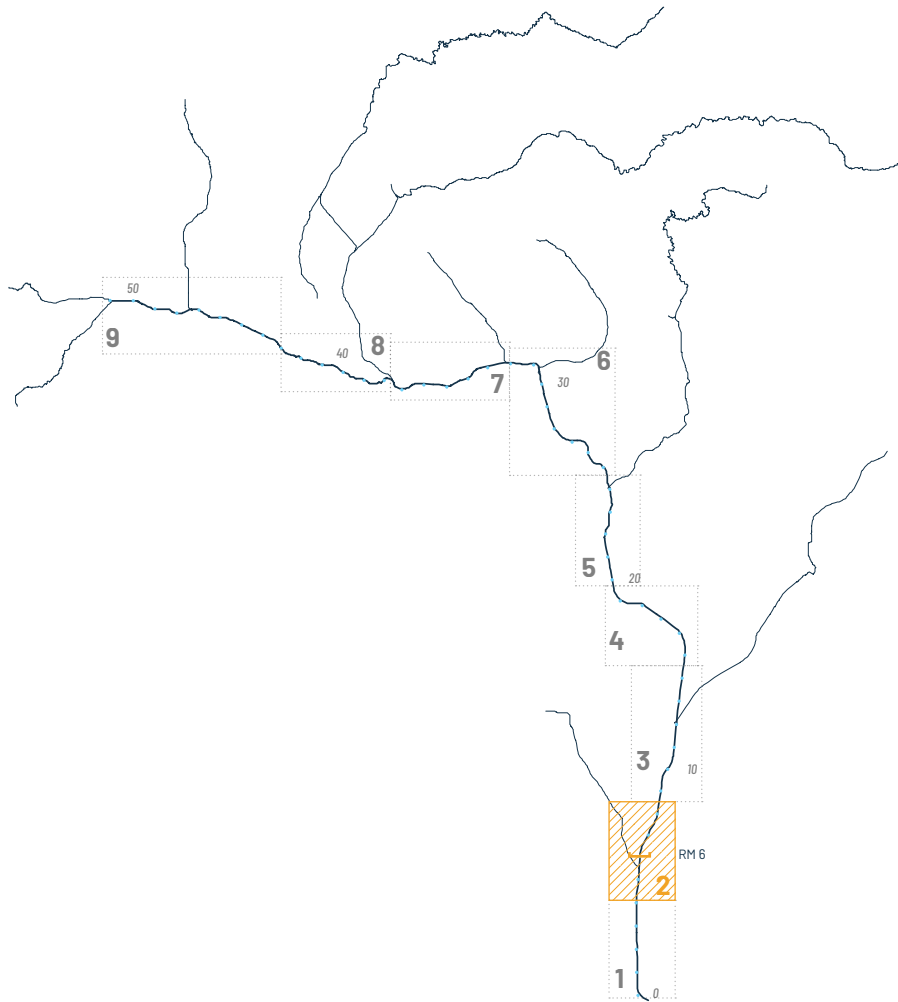


Figure 28. The channel in LA River Planning Frame 2 has a trapezoidal concrete section. There is a significant equestrian community that uses trails along this portion of the river.

# FRAME 1: ESTUARY

**Location:** City of Long Beach; river mile 4.0 - 0.0

**Channel Characteristics:** The channel in this frame is a leveed trapezoidal concrete cross section with a width of approximately 400 feet. The soft channel bottom with year-round water transitions at river mile 3 to a concrete bottom section with hard rip-rap sides, with a typical width of 585 feet.

**Average Channel Slope:** < 0.1%

**Landside Right-of-Way Characteristics:** This frame contains east and west facing parcels along levee, with areas that vary from approximately 15 feet to 100-150 feet wide.

## Notable Features:

- Estuary (including projections for sea level rise)
- Important bird habitat area
- Brackish water year round
- Present transition from river channel to soft bottom estuary at Willow Street
- Wrigley Greenbelt from river mile 2.9 to 4.0 along the left bank
- Santa Cruz Park, Golden Park, and Cesar Chavez Park from river mile 0.3 to 0.8 along the left bank, bisected from the river by West Shoreline Drive
- Shoreline Aquatic Park and the Queen Mary at river mile 0

## Significant Design Considerations for this Frame:

- This frame is in closest proximity to the ocean and Port of Long Beach, with unique site conditions for projects along the LA River.
- Projects here are potentially subject to high amounts of salt spray and salt content in the water and soil. Material and plant selections should be able to tolerate these conditions.
- Raised banks along the channel bottom allow for planting and should be managed as to not encourage the spread of invasive species.
- The wide ROW parcels, year-round presence of water, and proximity to the ocean provides opportunities for the creation and enhancement of valuable coastal habitat such as wetlands and nesting grounds.
- Sea level rise may occur in coming decades in this frame.



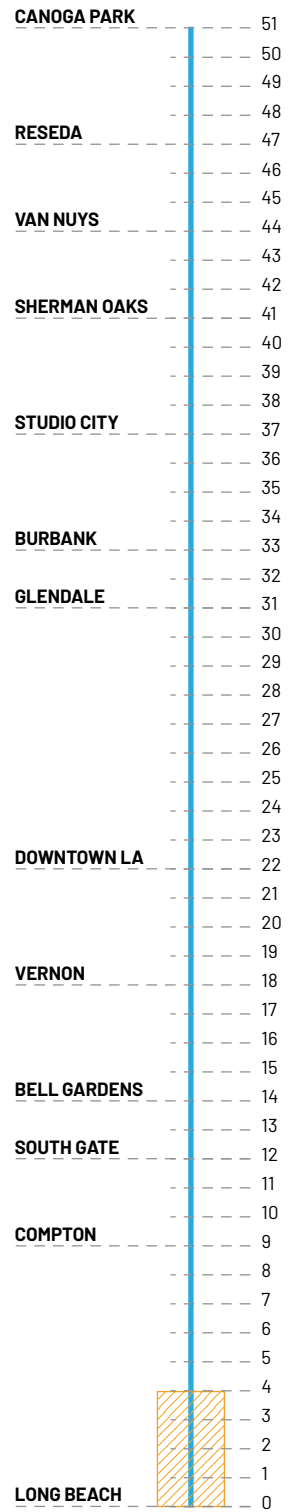
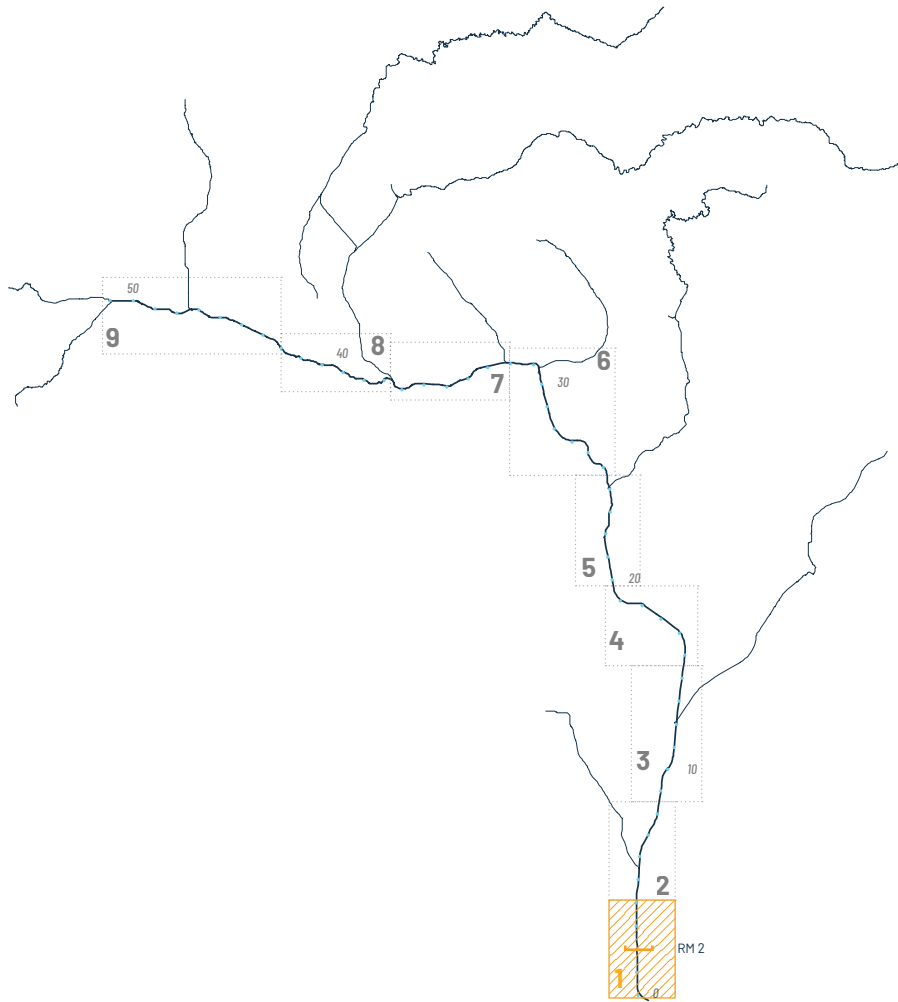
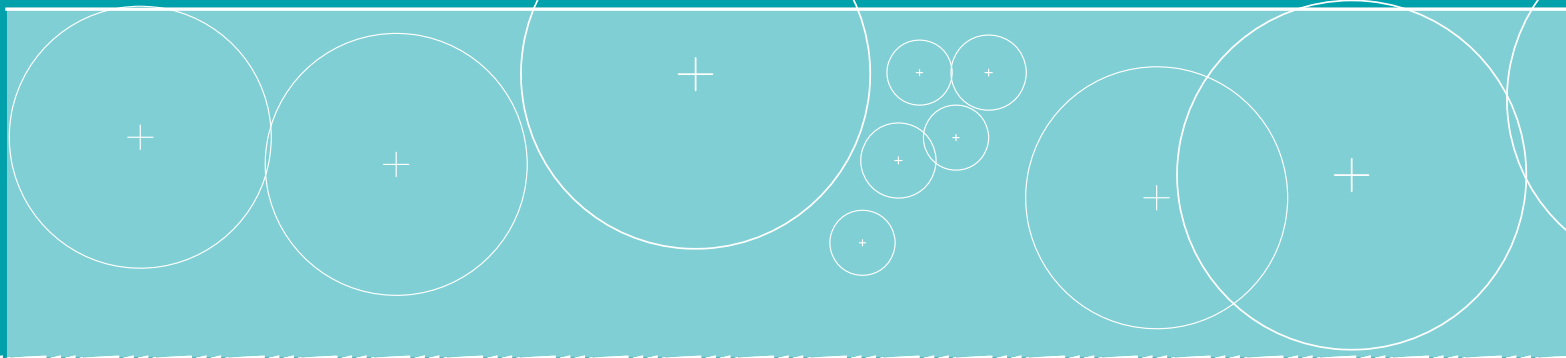
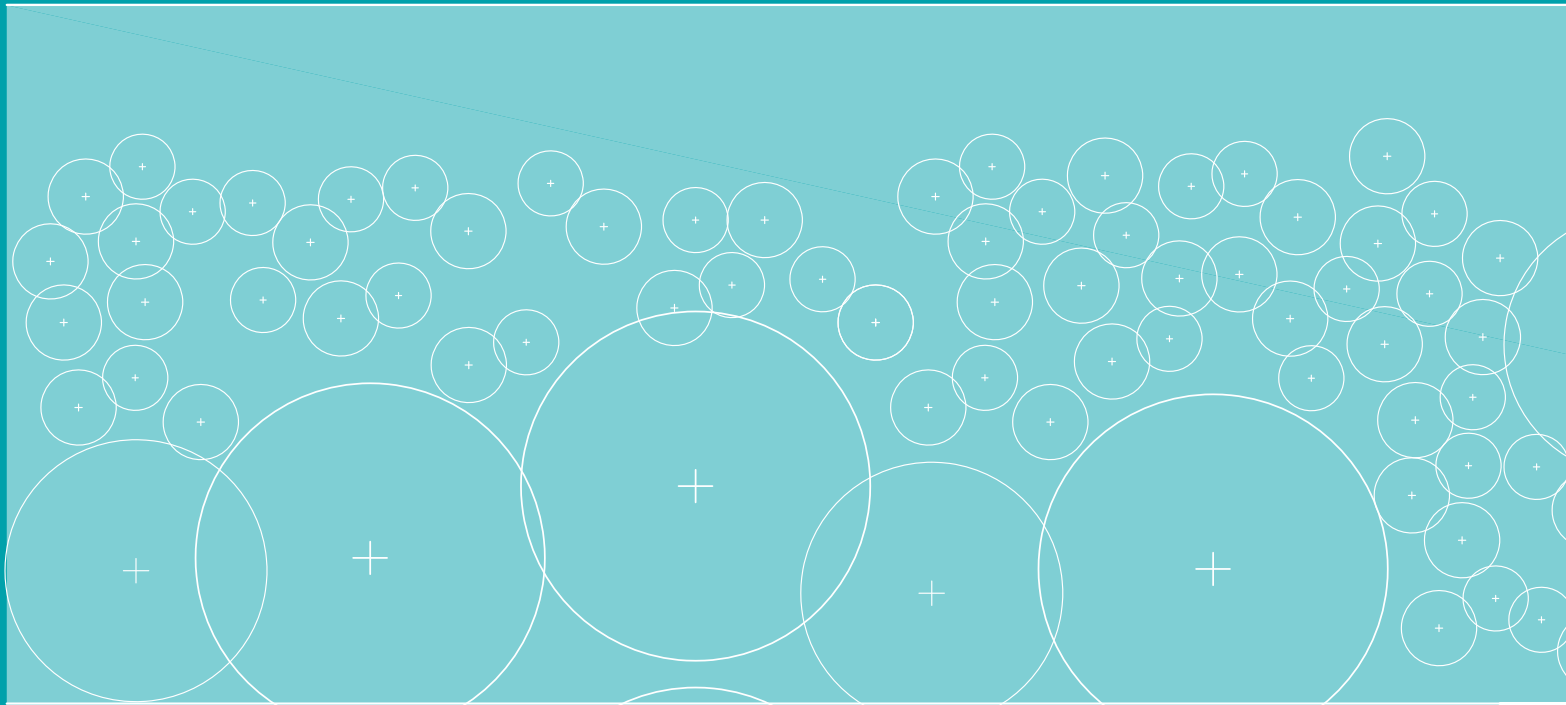
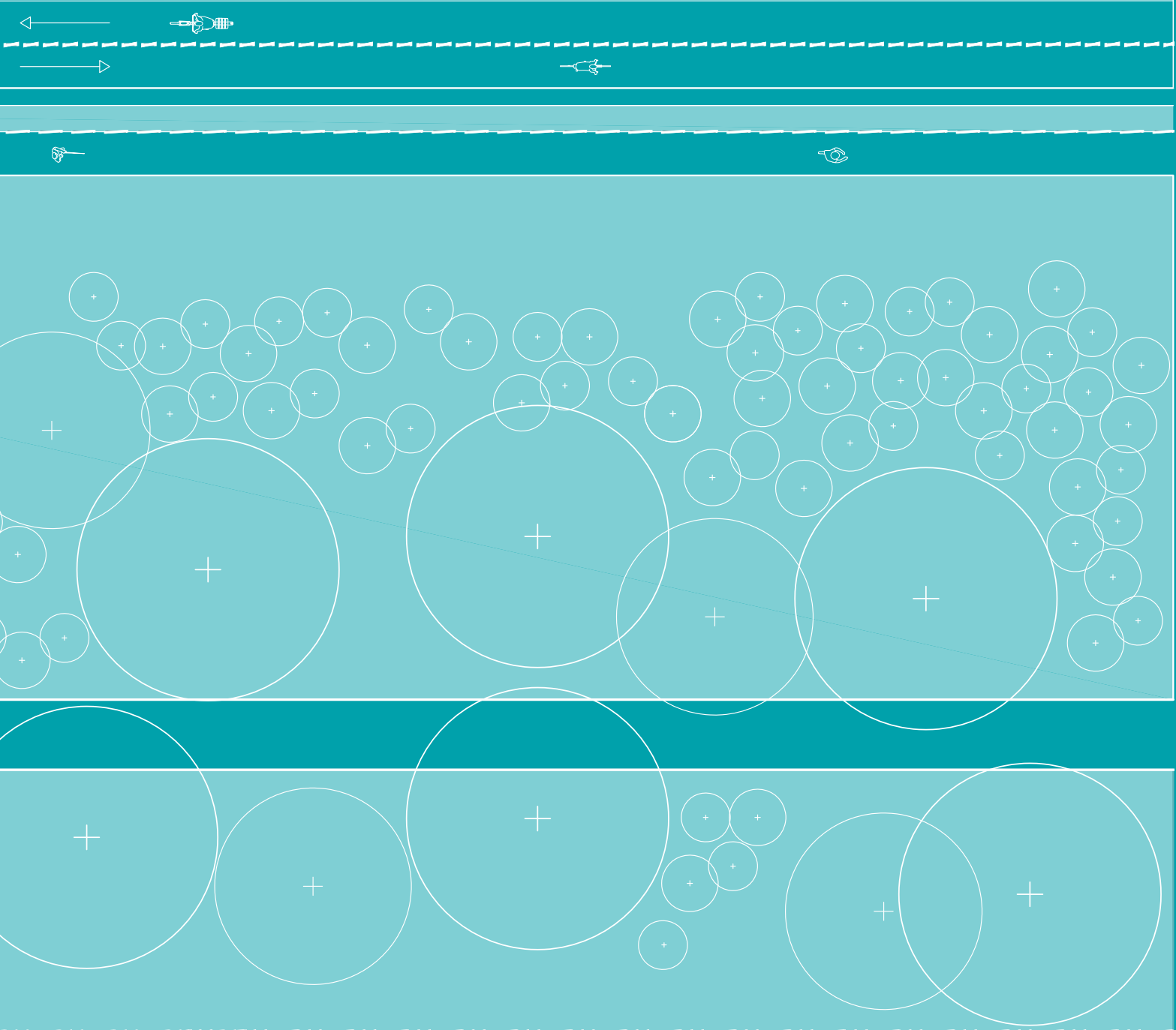


Figure 29. The estuary in LA River Planning Frame 1 contains brackish water and is a significant bird habitat.










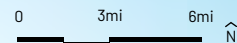




# SECTION II: DESIGN GUIDELINES

# LA RIVER ACCESS

-  Metro Rail Stop within 1 mi of access point
-  Bus Stops within 1/2 mi of access point
-  Access Point
-  Existing LA River Trail
-  Proposed LA River Trail
-  Bike Path/Lane Connected to River Path
-  Other Bike Paths and Lanes



**Figure 30. LA River Access. Access points, trails, and public transportation stops along or adjacent to the LA River.**  
 Source: LA River Master Plan, 2020.

# 3.

## ACCESS AND MOBILITY

### BUILDING AN INCLUSIVE MULTI-MODAL NETWORK FOR THE RIVER

The LA River is intended to be a resource for use by all people in LA County. To be this resource, the river must be accessible and usable. In community meetings and surveys during the LA River Master Plan process, people indicated that walking and biking are the two activities they participate in the most along the river, with combined participation more than all other activities combined. However, ease and availability of access to trails along the LA River is highly variable.

Trail guidelines ensure a degree of consistency in experience from one segment of the LA River trails to the next. Whether LA County Public Works or one of its partners implements a segment of trail, it should meet the same minimum standards. The more regular and frequent access is to trails along the LA River, the more people from surrounding communities will be able to take advantage of these amenities. With increased visibility of access points and consistency of experience, more people will become aware of the river and the experience of using any part of the river will become more familiar. As trails along the LA River become better connected to other trails in the county network, the value of the river trail will increase exponentially, opening up destinations that people can reach by getting on the river trails and making the LA River a destination by trail for more of the county. Better connections to transit will enable those without cars the opportunity to take advantage of the river and increase the viability of multi-modal trips. Finally, the addition of amenities such as water fountains or benches at regular intervals will make the experience more pleasant for both the casual recreation user and the seasoned commuter (see Chapter 6 for further discussion on amenities).

# WHAT'S IN THE CHAPTER

The following pages contain the dimensional and material guidelines for multi-modal trails connecting to and along the LA River. This chapter will provide information regarding right-of-way scenarios, gateways, and bridges among other aspects related to access and mobility. The designer or engineer shall be responsible for ensuring the implementation of these guidelines is compliant with prevailing building codes and regulations. Consult the checklist at the end of the chapter to ensure the correct guideline items are followed.

<b>63</b>	<b>3. Access and Mobility</b>
64	What's in the Chapter
66	Multiuse Trails
69	Trail Components
70	Right-of-Way Combinations
72	Trails in Wide Right-of-Way Areas
73	Trails in Narrow Right-of-Way Areas
78	Trail Assemblies
81	Paving Materials
83	Fences, Guardrails, Railings, and Gates
86	Gateways
88	Bridges
94	Access and Mobility Checklist





Figure 31. Chapter 3 of this document covers items related to access and mobility along the LA River.

**THE LA RIVER TRAIL SHOULD CONNECT TO OTHER TRAILS ALONG THE LENGTH OF THE RIVER TO CREATE A NETWORK OF TRAILS ACROSS LA COUNTY FOR CYCLISTS, PEDESTRIANS, AND EQUESTRIANS**

---

## MULTIUSE TRAILS

A primary goal of the LA River Master Plan is to create 51 miles of connected open space with equitable access, including trails, gateways, and access points. The LA River Trail should connect to other trails and paths along the length of the river to create a mobility network across LA County for cyclists, pedestrians, and equestrians. The LA River Trail should always seek to accommodate as many user types as safely possible, although all types of users may not always be accommodated based on specific projects and site conditions. Additionally, operations and maintenance vehicles need to access the right-of-way.

The various trail conditions along the LA River should be designed with their intended use in mind. Each type of trail user has different needs in terms of width and materiality.

### **SEPARATED USES: EQUESTRIAN, PEDESTRIAN, AND BICYCLE**

In a condition where ample right-of-way space is available, the pedestrian, bicycle, and equestrian trails should give each user group a dedicated passageway with buffers in between the trails. In this scenario, the condition of the buffer spaces between the paths is important. The vegetated buffers should be at least three feet wide. The trail widths shall be dictated by their expected usage and informed by the site conditions. A 12 foot minimum width is required for either the pedestrian or the bicycle trail to accommodate the service/maintenance vehicles.

When there is not enough space to separate all three trail uses, the pedestrian and bicycle trails should be adjacent to one another and a vegetated buffer or trail divider should be used to separate those uses from the equestrian trails. A 12-foot minimum width is required of the pedestrian and bicycle trails to provide access for service/maintenance vehicles.

### **ADJACENT USES: EQUESTRIAN, PEDESTRIAN, AND BICYCLE**

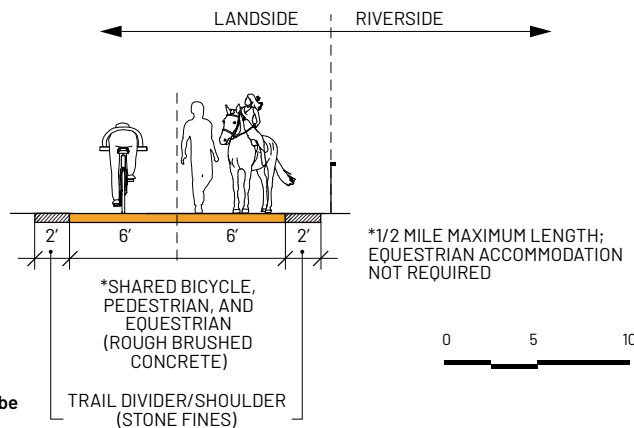
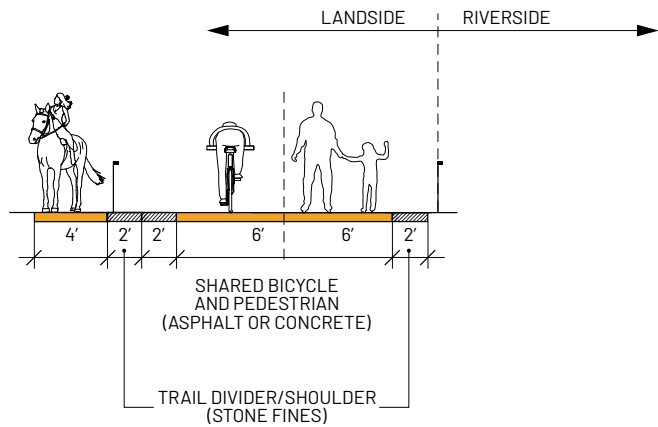
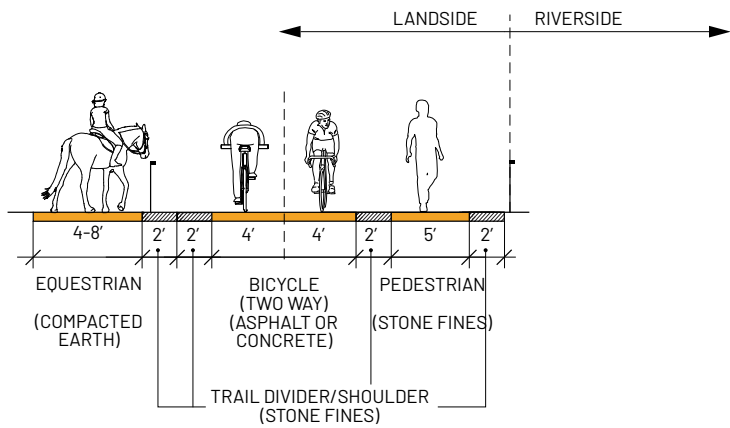
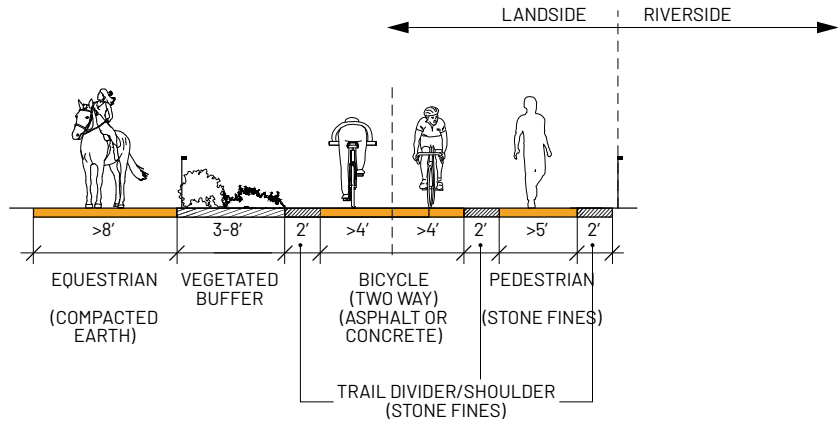
Where there are more space constraints in the LA River right-of-way, pedestrian and bicycle trails may need to be directly adjacent or share a trail. These two trails can coexist next to one another as long as there is correct striping and clear signage designating the trail uses. The combined width must be a minimum of 12 feet to provide access for service and maintenance vehicles.

### **COMBINED USES: EQUESTRIAN, PEDESTRIAN, AND BICYCLE**

In some instances along the river where there is the tightest right-of-way, the most efficient trail option is a single trail that is designed to be used by pedestrians, bicyclists, and equestrians. Clear trail environmental graphics and striping must be present. For equestrian uses, rough brushed concrete paving should be installed at a recommended length of half a mile maximum. The width of this multiuse trail must be a minimum of 12 feet to provide access for service and maintenance vehicles.

PREFERRED

### MULTIUSE TRAIL COMBINATIONS



MINIMUM

Figure 32. Multiuse trails can be designed in different ways depending on available width. Ideally equestrians would be separated from pedestrians and bicyclists with a buffer. Dimensions illustrated for bikes are based on the LA County Bike Plan.

### COMPONENTS OF MULTIUSE TRAILS



Figure 33. Pedestrian, bicycle, and equestrian trail components vary in width and are most often used in combination with one another, but they may also be implemented as standalone trails in certain projects. Dimensions illustrated for bikes are based on the County of LA Bike Plan.



**ALL PEDESTRIAN AND BICYCLE TRAILS  
MUST HAVE 2 FEET OF SHOULDER  
ON EACH SIDE IN ADDITION TO THE  
TRAIL WIDTH**

---

## **TRAIL COMPONENTS**

### **PEDESTRIAN TRAILS**

Pedestrians make up the largest user group of the river. The main paths of travel should be linear and efficiently designed for active transport. Paths that are for passive uses may meander. The pedestrian trails should range anywhere from 4 feet wide (for secondary/recreation use only) up to the preferred 12 feet wide where there is a need to share the space with other types of users. At least two foot shoulders should be provided on either side of the path. Regardless of usage, there must be clear visibility to the surrounding paths for safety.

### **BICYCLE TRAILS**

Bicycle trails along the entirety of the river should be designed to meet Caltrans Class I minimum standards with a design speed of 20 mph. These trails should allow for four foot lanes of two-way traffic with two foot shoulders on each side. Clear environmental graphics and striping must be included for safety (see "Bike Trail Paint" in Chapter 4 for more details).

### **EQUESTRIAN TRAILS**

Where possible, equestrian trails should be kept separate from other trails. Equestrian trails should range from 4 feet wide, where low usage is expected, to 12 feet wide, where high, two-way usage occurs. Where applicable, they should provide safe access across the river bed and to other recreational areas. Equestrian trails exist adjacent to the river in several places. Linking these facilities in the future would provide equestrians with greater opportunities for all day rides or longer trail loop systems not currently available.

When there is not enough space to accommodate all uses, the first priority remains to create a connected LA River Trail. Design teams shall determine a method to maintain pedestrian and bicycle connections regardless of constraints.

## RIGHT-OF-WAY COMBINATIONS

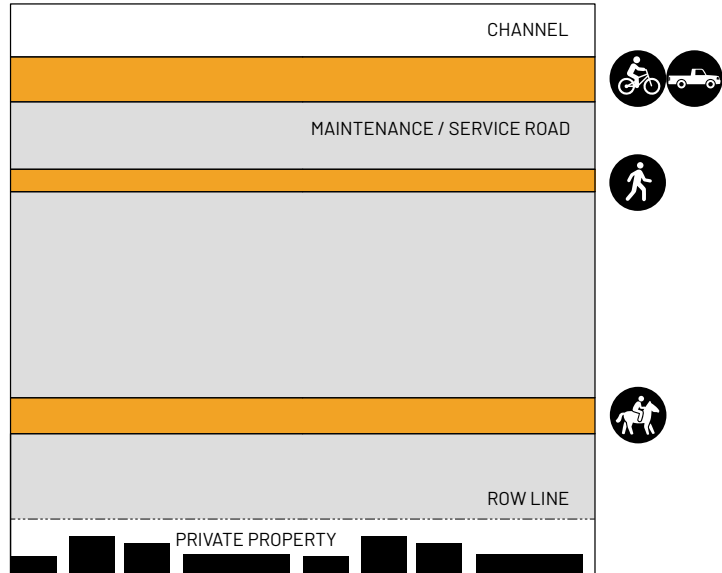
The design and location of trails is primarily affected by the channel configuration, the US Army Corps of Engineers (USACE), City of Los Angeles, or LA County (LAC) right-of-way widths, maintenance requirements of flood control and auxiliary uses, and utility easements.

The right-of-way conditions along the LA River vary substantially in each frame. LA County Public Works and the USACE maintain various segments of the river channel. To access and maintain the river, these rights-of-way contain service roads, both paved and unpaved, along the top of the channel. These service roads are used by LAC and the USACE crews to inspect the channel, clean out weir structures on an annual basis at various locations, and respond to emergency situations. The location of the service road varies depending on the right-of-way condition. In general, there are 4 different existing sizes of right-of-way:

- Extra Large ( >12 feet, extends beyond base of levee)
- Large ( >12 feet, along entrenched condition)
- Narrow (approximately 12 feet)
- Very Narrow ( < 12 feet)

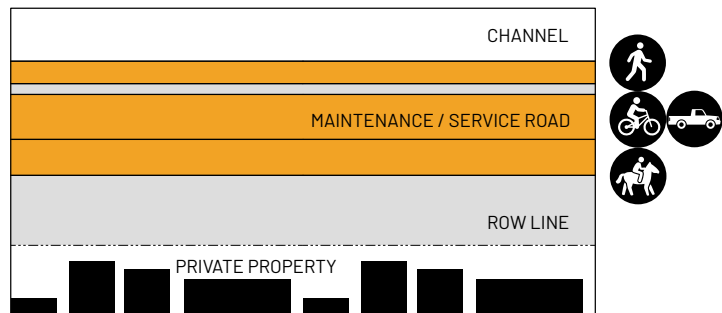
Within each of the different existing right-of-way conditions, the trails and service roads are organized in different ways. Along some sections of the river, the service road runs along both banks and in some sections on one bank. Through the industrial parts of downtown LA and in the San Fernando basin, no room is currently provided for service roads. Where there is less than 12 feet of right-of-way width, a cantilevered multiuse trail may be necessary.

## EXISTING RIGHT-OF-WAY TYPOLOGIES



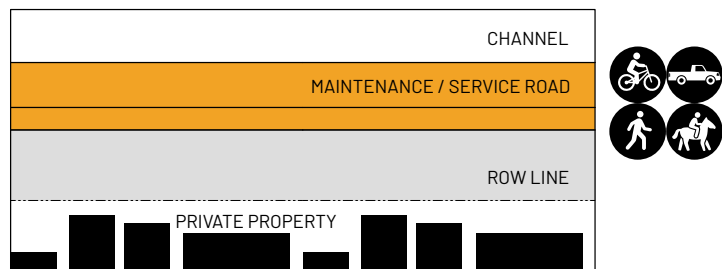
### EXTRA LARGE RIGHT-OF-WAY

See Figure 35 on page 72.



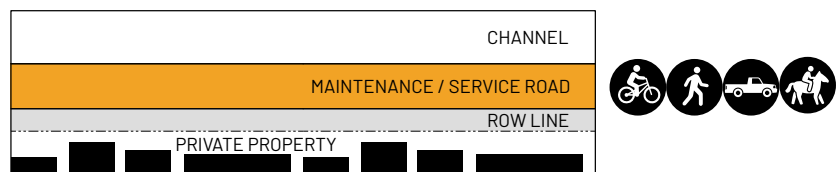
### LARGE RIGHT-OF-WAY

See Figure 36 on page 73.



### NARROW RIGHT-OF-WAY

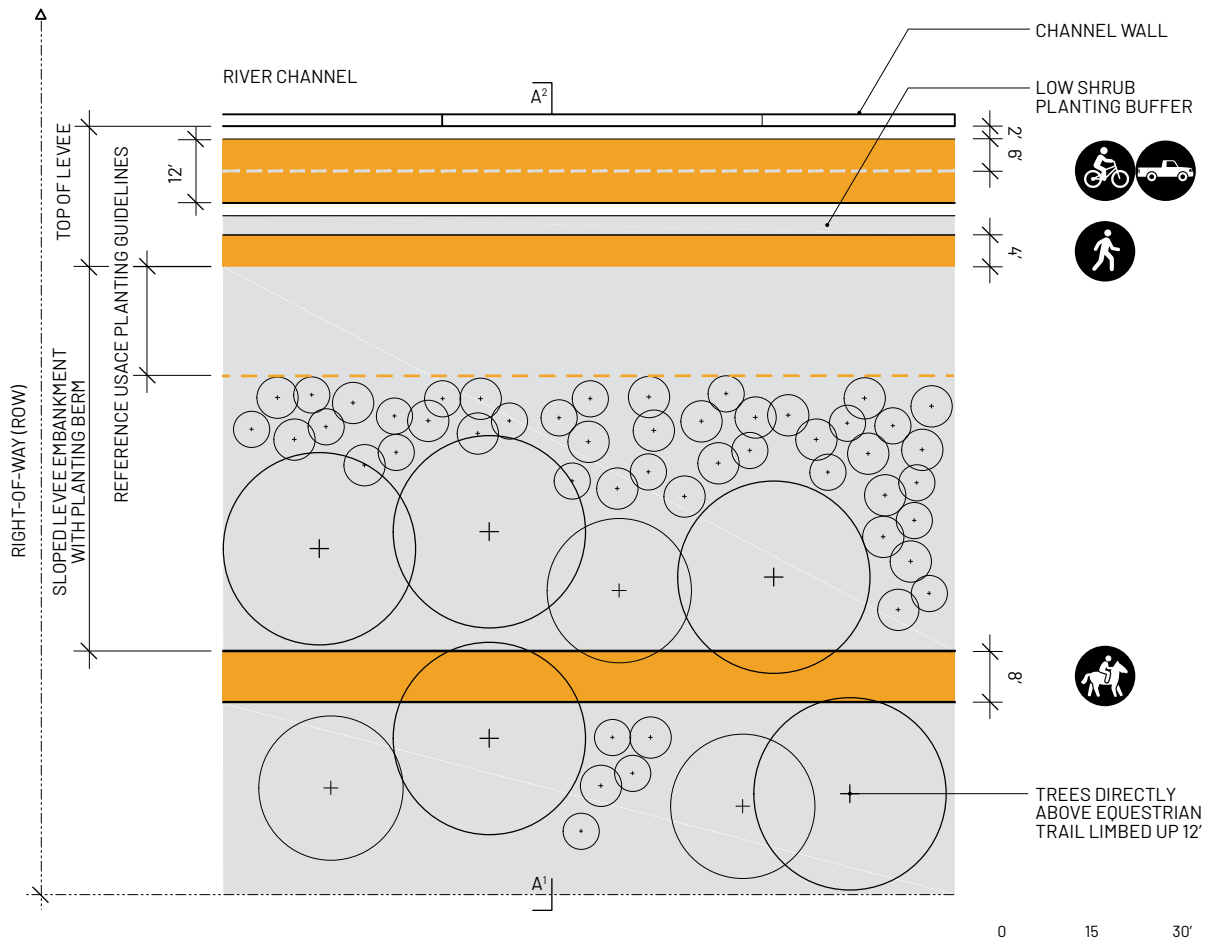
See Figure 37 on page 74.



### VERY NARROW RIGHT-OF-WAY

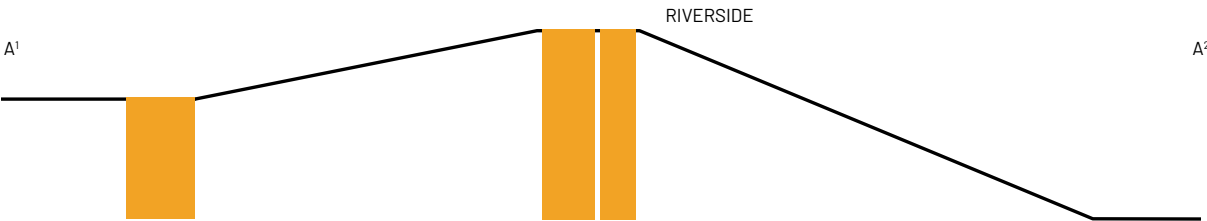
See Figure 38 on page 74.

Figure 34. Existing right-of-way conditions vary greatly along the 51 miles of the river. In general, there are four typologies that represent the majority of conditions along the river.



**WIDE LANDSIDE ROW > 12', SEPARATED MULTIUSE TRAIL ALONG LEVEE**

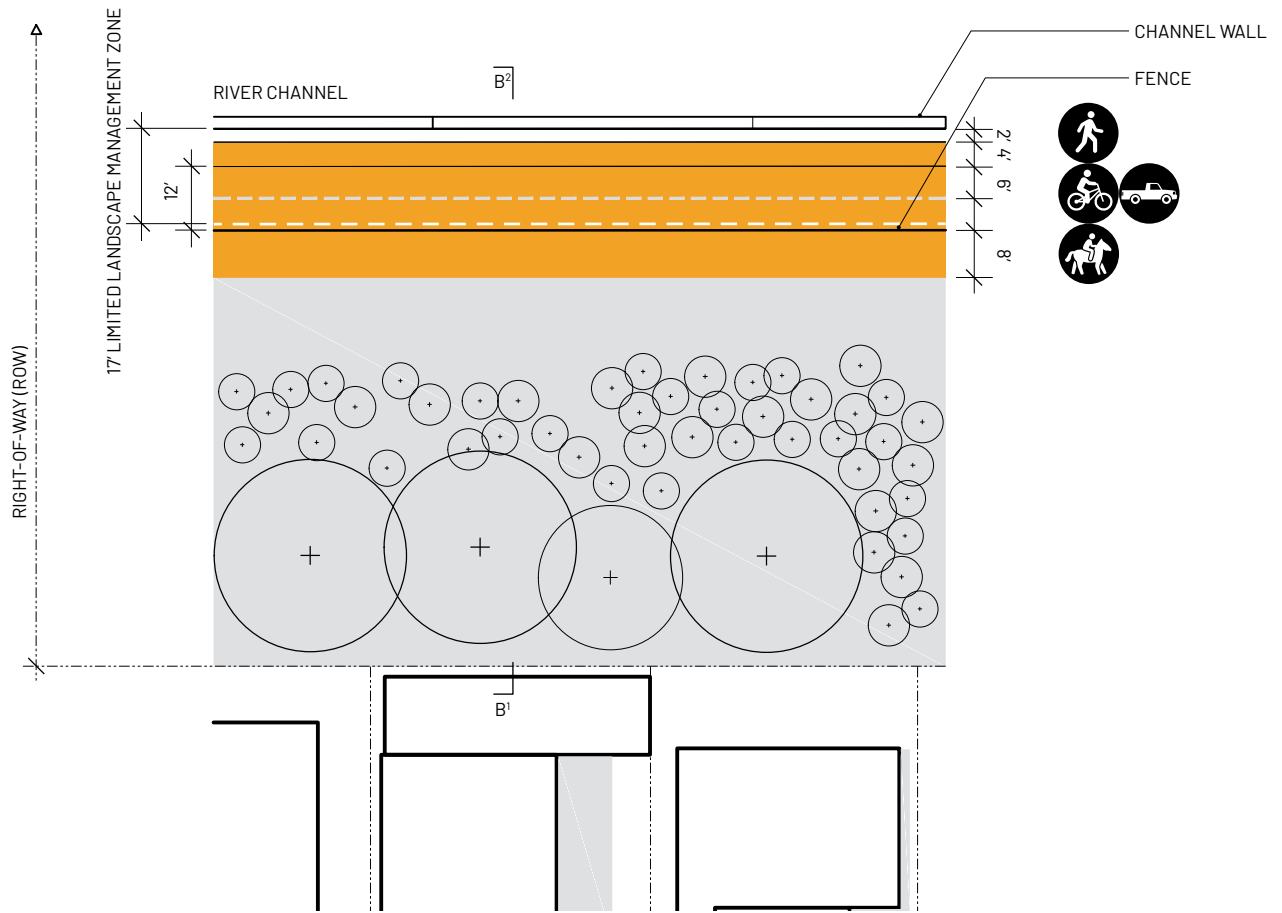
Figure 35. A wide landside ROW would allow for the separation of trail types. This presents the possibility to have wide trail dimensions and highest safety measures. This figure represents one possible configuration of this typology.



# TRAILS IN WIDE RIGHT-OF-WAY AREAS

Areas with large rights-of-way along the LA River should utilize that space to separate the different trail typologies. To promote safe usage, bicycle, pedestrian, and equestrian trails should have their own designated trails with adequate buffers or trail dividers. Special consideration should be given to areas where different types of trail users intersect, such as access points and bridge crossings.





**WIDE LANDSIDE ROW > 12', CONSOLIDATED MULTIUSE TRAIL ALONG ENTRENCHED CHANNEL**

Figure 36. Trails may be consolidated when a wide landside ROW is present. When the trails are consolidated, more land becomes available for parks, planting, and habitat. This figure represents one possible configuration of this typology.



## TRAILS IN NARROW RIGHT-OF-WAY AREAS

Connectivity of the trail network along all 51 miles of the LA River is critical, therefore, in areas where the right-of-way is narrow, innovative methods to create connectivity should be explored, such as cantilevers, bridges, elevated trails, and platforms. When necessary, paths can be shared by cyclists, pedestrians, and equestrians.

**RIGHT-OF-WAY CONDITIONS VARY GREATLY ALONG THE 51 MILES OF THE LA RIVER. THE FIGURES ABOVE REPRESENT ONE POSSIBLE CONFIGURATION OF THE RIGHT-OF-WAY**

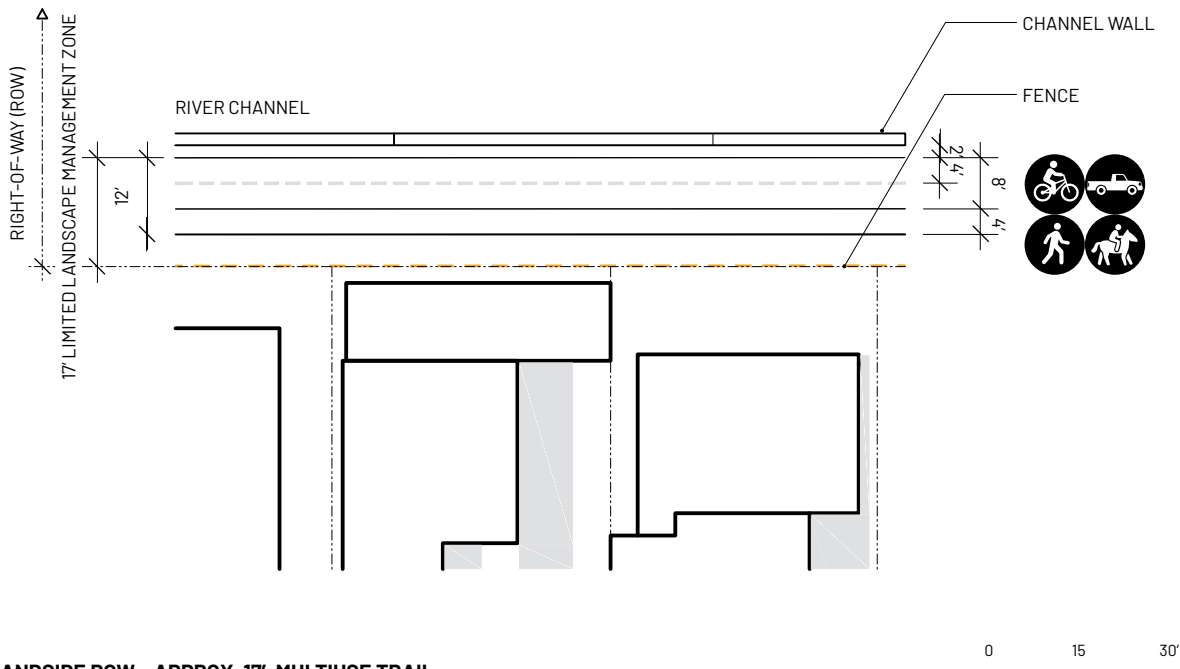


Figure 37. Narrow landside ROW allow for the separation of pedestrian and bike trails. However, they do not allow room for separate equestrian trails. In this condition, room for buffer planting is present, allowing separation between the trail users and the property owners. This figure represents one possible configuration of this typology.

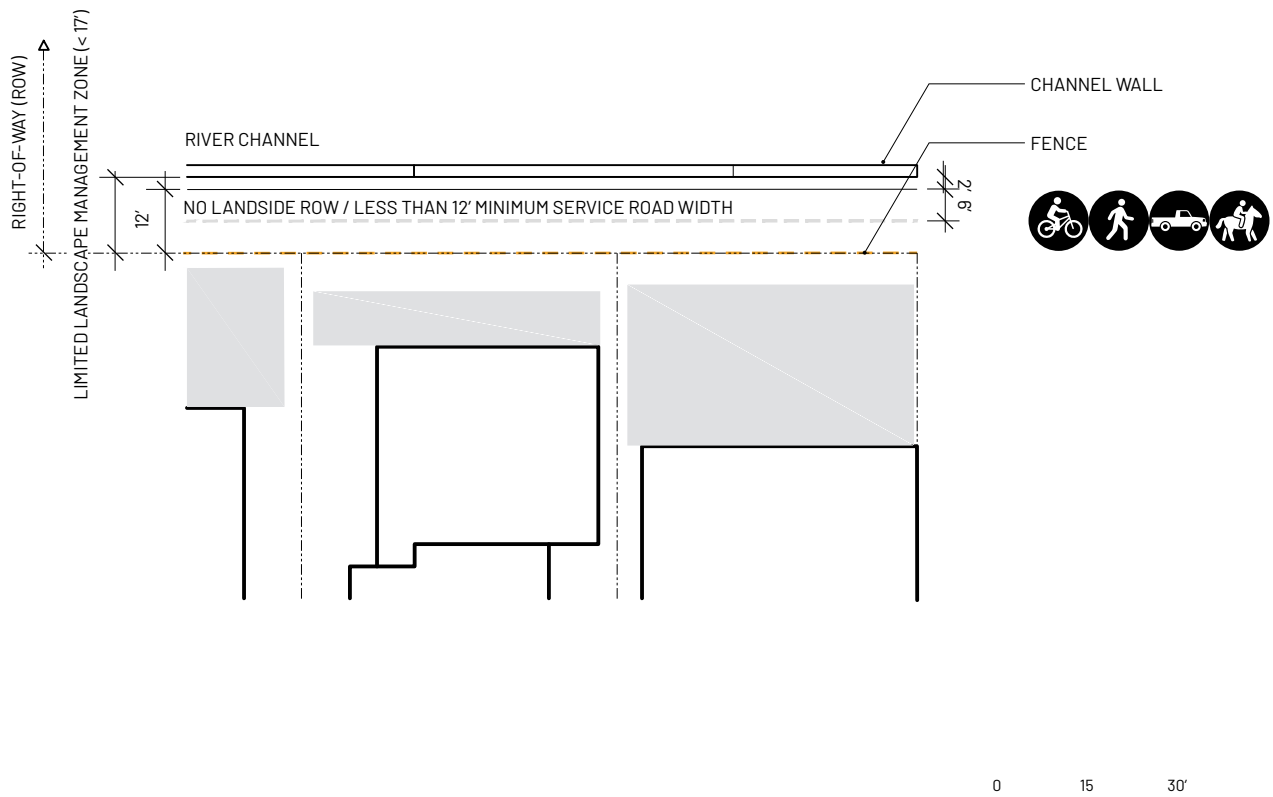
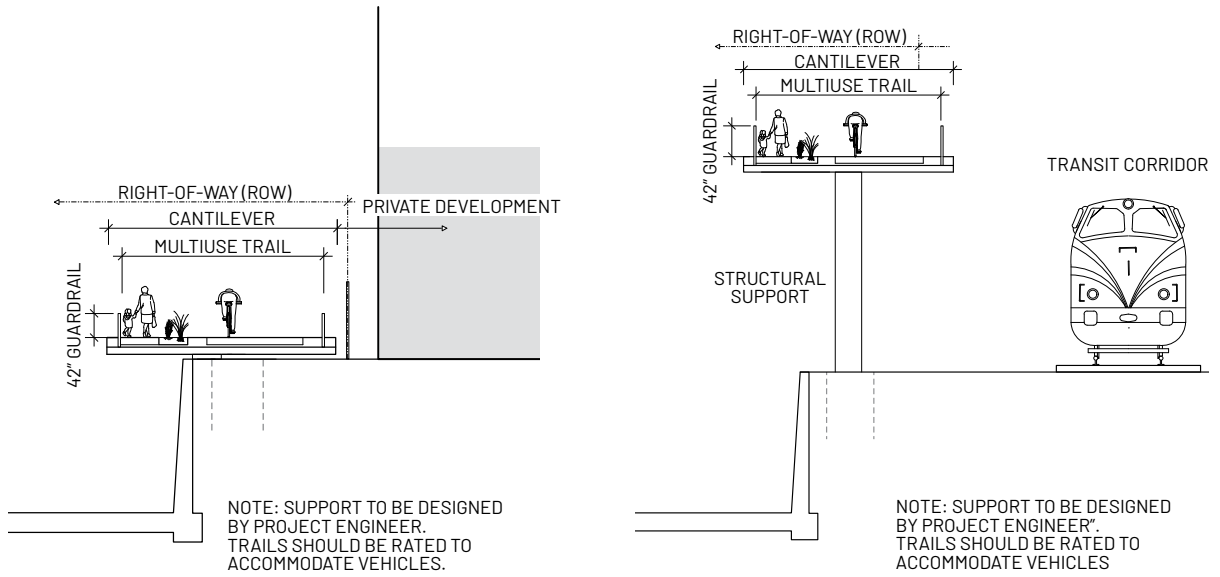


Figure 38. Narrow landside ROW allow for the separation of pedestrian and bike trails. However, they do not allow room for separate equestrian trails. This figure represents one possible configuration of this typology.



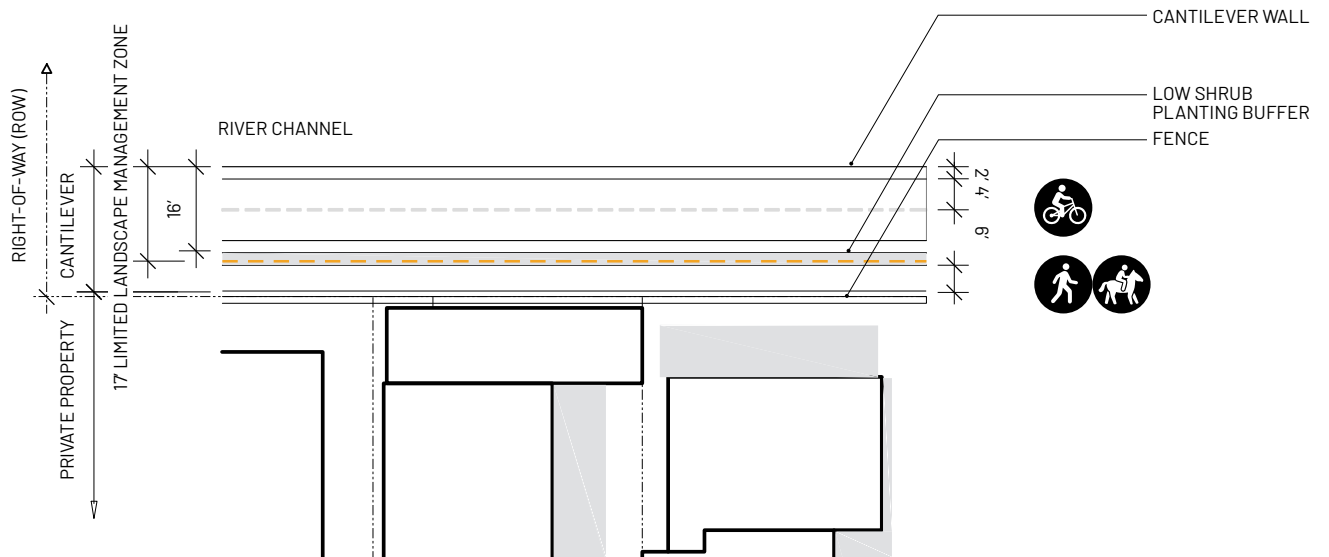
NOTE: SUPPORT TO BE DESIGNED BY PROJECT ENGINEER. TRAILS SHOULD BE RATED TO ACCOMMODATE VEHICLES.

NOTE: SUPPORT TO BE DESIGNED BY PROJECT ENGINEER\*. TRAILS SHOULD BE RATED TO ACCOMMODATE VEHICLES



**NO LANDSIDE ROW, CANTILEVERED OR ELEVATED MULTIUSE TRAIL**

Figure 39. The cantilevered and elevated trails allow pedestrians and cyclists to utilize the ROW when there is not enough room between the channel and adjacent property, infrastructure, or utilities. Guardrails on both sides of the trail help keep users safe. This typology could stay open during storm events and offer elevated views. This figure represents one possible configuration of this typology



**NO LANDSIDE ROW, CANTILEVERED MULTIUSE TRAIL**

Figure 40. For instances where there is no landside ROW, a cantilevered condition can create space for an accessible multiuse trail. This figure represents one possible configuration of this typology.

# MULTIUSE TRAILS IN WIDE ROW: BEST CASE SCENARIO

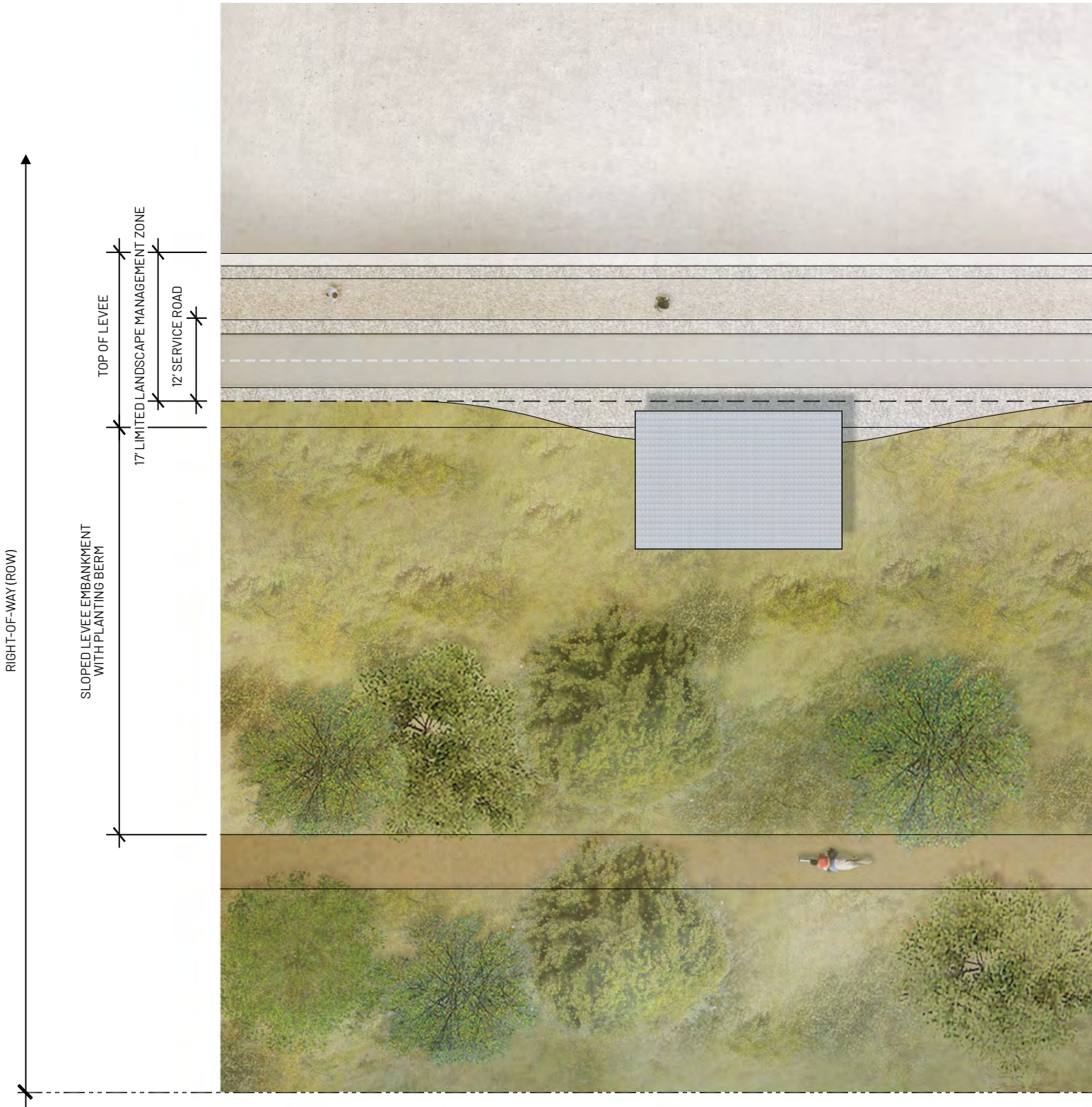
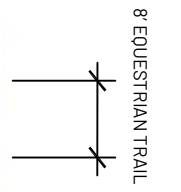
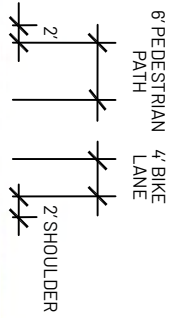


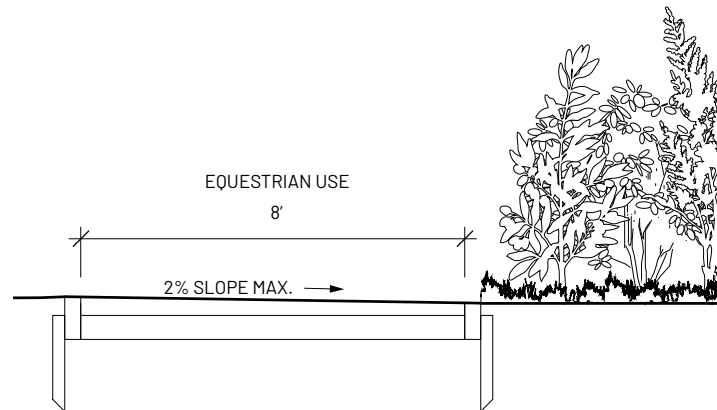
Figure 41. Wide landside ROW allow for the separation of trail types with vegetated buffers. This figure represents one possible configuration of this typology.





## TRAIL ASSEMBLIES

The relationship between the trails and their adjacent conditions should be considered when designing and constructing along the LA River. While the trail widths vary based on the combination of usage type and materiality, there are design principles that should be followed universally where possible. To improve water quality, trails should generally slope away from the river channel and filter runoff prior to discharge into the channel. In some circumstances, such as elevated or cantilevered paths, underpasses, and tight right-of-ways, this condition may not be preferred.



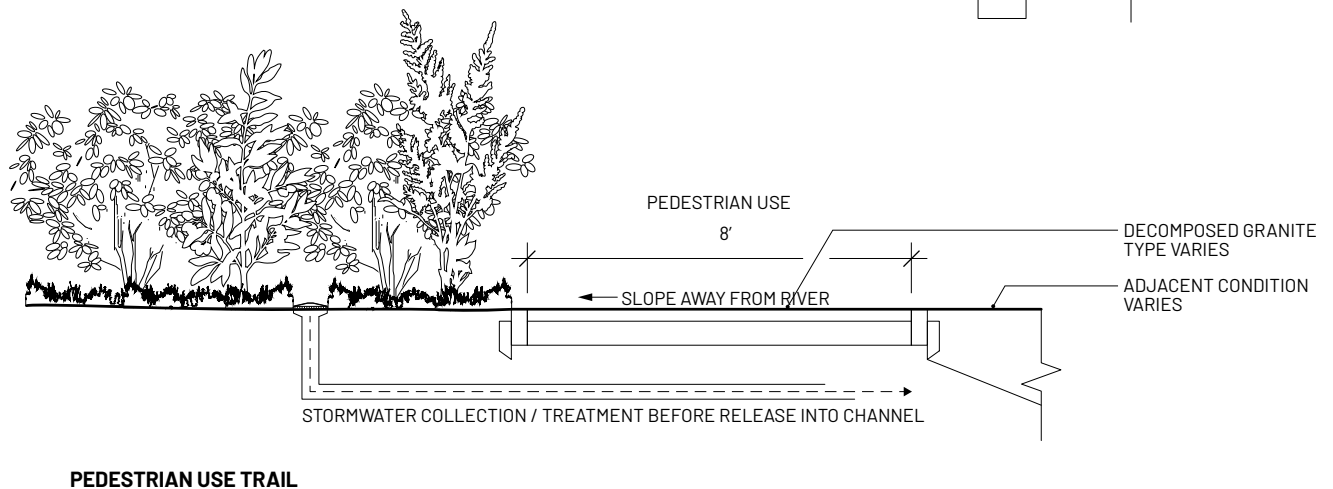
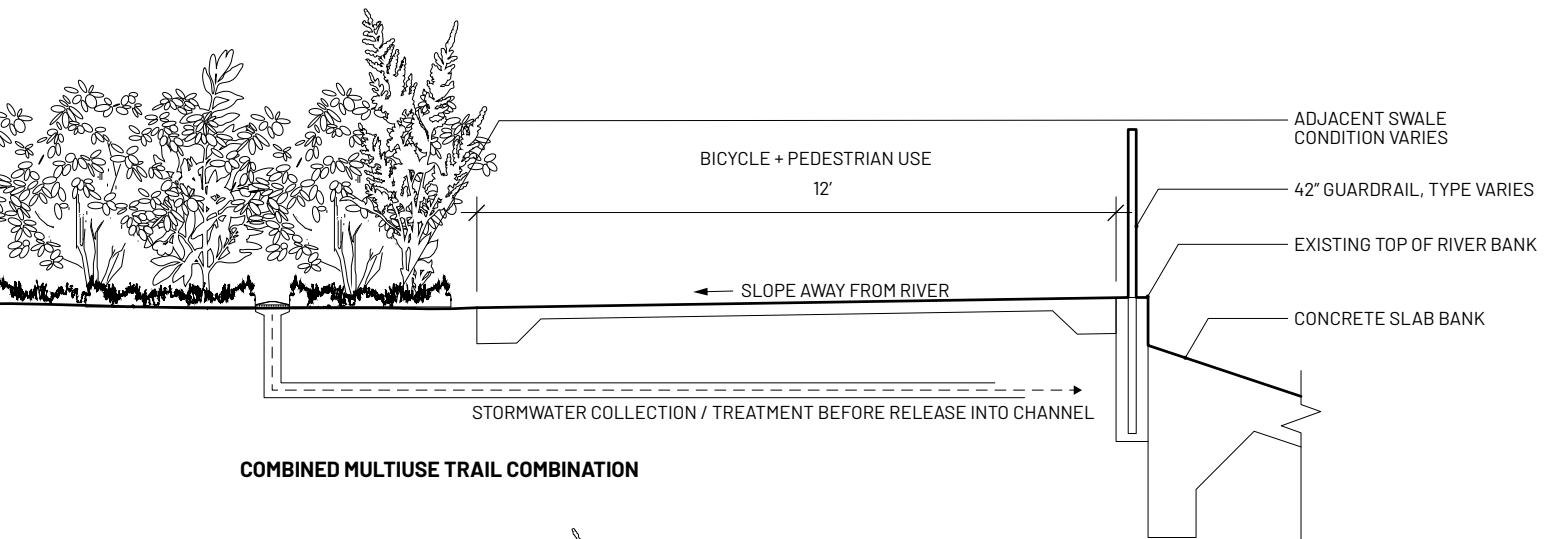
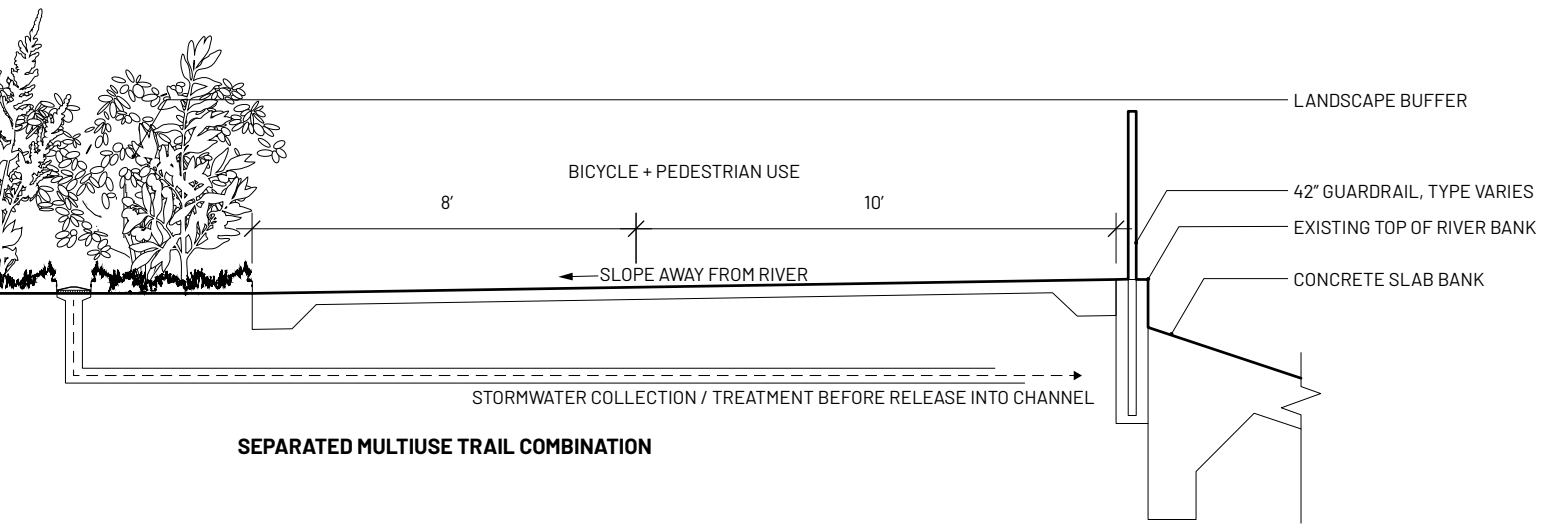
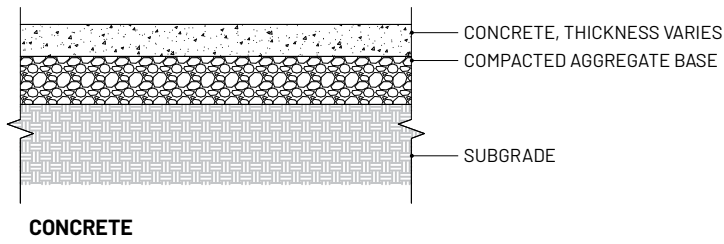


Figure 42. Where possible, trails should slope away from the river and to a landscape drain or infiltration zone. That water should then be filtered and conveyed into the river.



## PAVING TYPOLOGIES



## PAVING EXAMPLES

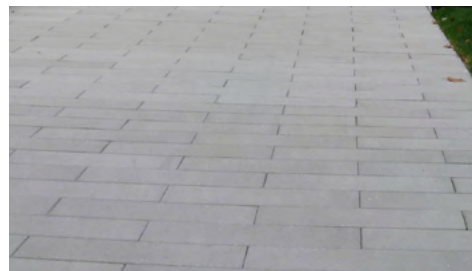
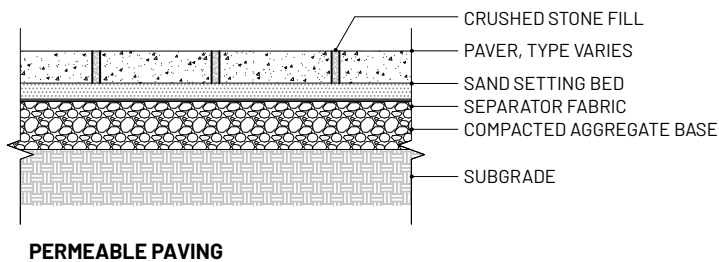
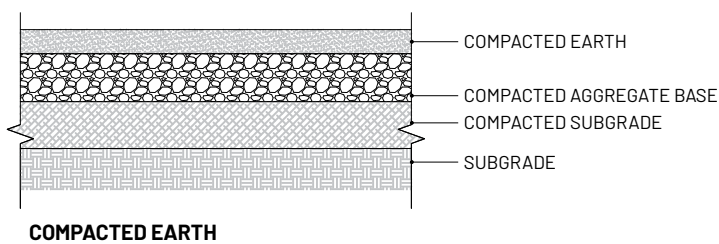
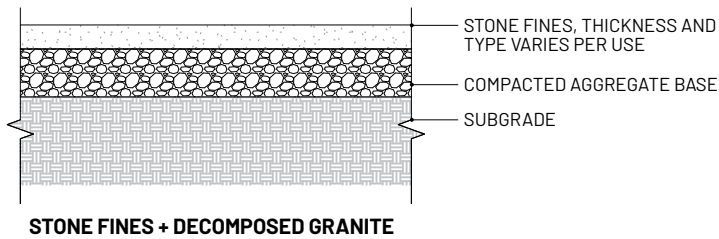
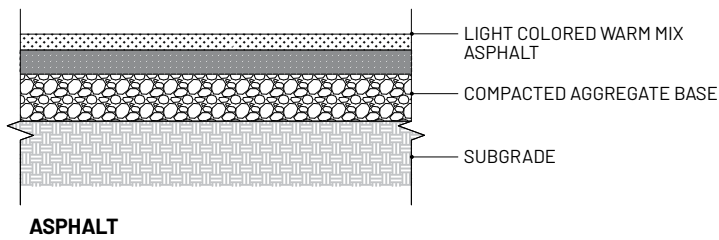


Figure 43. Paving types are not limited to those above and vary based on the intended use. Paving material thicknesses and sub-base dimensions vary according to use. Any geotechnical conditions should be studied and reviewed by a licensed State of California civil engineer.  
 Source: All images OLIN, 2019.



## USED FOR

- Maintenance and service roads
- Bicycles
- Pedestrians
- Equestrians (must be rough brushed)

- 
- Maintenance and service roads
  - Bicycles
  - Pedestrians

- 
- Pedestrians
  - Equestrians

- 
- Maintenance and service roads
  - Equestrians
  - Pedestrians

- 
- Pedestrians
  - Gathering spaces

# PAVING MATERIALS

There is no single perfect material for trails along the LA River. Cyclists prefer smooth continuous surfaces such as asphalt or concrete whereas pedestrians typically prefer more forgiving surfaces such as bonded stone fines and equestrians a larger aggregate.

When possible, these “ideal” surfaces should be used; however, all design conditions, material thicknesses/assemblies, and colors should be reviewed by design professionals for site specific considerations. Additionally, paving has the potential to feature artwork.

**Concrete:** A durable paving material that consists of aggregate and cement over a compacted aggregate base. Suitable for maintenance roads and bicycle and pedestrian trails.

**Asphalt:** Durable and relatively inexpensive paving material that consists of aggregates held together by asphalt cement over an aggregate base. Can withstand heavy loads of a maintenance vehicle, while also being a suitable material for bicycle trails. A light-colored, low VOC warm mix must be used to offset the urban heat island effect. Coal-tar-based pavement sealcoat should not be used.

**Stone Fines and Decomposed Granite (DG):** A stable, natural-looking paving material consisting of crushed rock that can be found in a variety of different colors and granular sizes. A larger granular size is recommended, as fine DG becomes slippery when wet. Where erosion is a concern, DG should be protected with a resin-binder and should not be used on sloped areas greater than 3% unless a drainage system is installed.

**Compacted Earth:** This inexpensive method should be primarily used for equestrian trails when no other option is available since erosion and wear can be a maintenance problem. Care should be taken to stabilize the path with a well-graded aggregate base.

**Permeable Paving:** Crushed stone fill between paving, or open, coarse aggregate held together by asphalt concrete or cement. Problems can occur with silting which reduces permeability if surfaces are not cleaned and maintained regularly to allow maximum water percolation.

## WHERE TO SITE FENCES, GUARDRAILS, AND RAILINGS

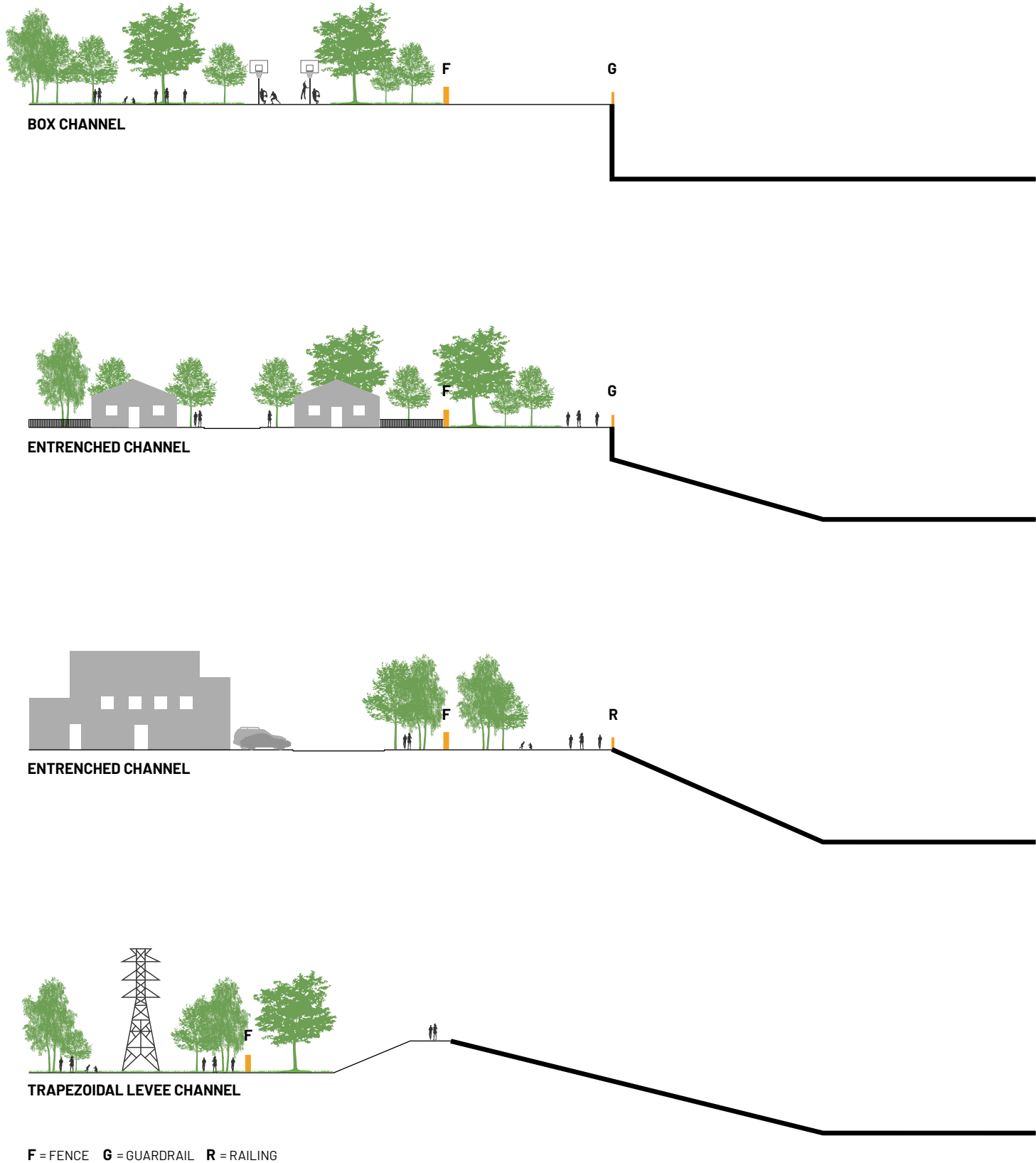


Figure 44. Fences, guardrails, and railings should be utilized in the correct locations along the river. These locations are dictated by channel characteristics, user access, adjacent land uses, and programming.

# FENCES, GUARDRAILS, RAILINGS, AND GATES

Use of the river corridor for public activities requires the re-evaluation of fencing in terms of function, aesthetics, and the perception of safety vs. real hazard. Designers should incorporate fencing that blends in with the environment as much as possible. Fences to keep the public away from the channel are not applicable to an open space corridor, except where public safety is a concern. In some areas along the LA River, vertical drops require guardrails for fall protection. In other areas, a simple railing may be recommended where steep slopes are adjacent to paths of travel.

Opportunities exist to provide the appropriate type of fencing for a variety of proposed recreational uses and to remove fencing that is redundant or does not meet a multi-objective approach to river management. This includes situations that utilize a fence to disconnect the river from adjacent parks and other public open spaces rather than provide the parks an opportunity to function as part of the river corridor by gating the park entrance. Additionally, designers can consider reducing fencing and railings along the LA River in order to allow users to step aside to alleviate traffic from multiuse trails.

The reduction of fencing along the LA River is reliant on:

- The reduction of public hazards
- The implementation of other types of buffers and barriers
- Safety/warning notification system including a comprehensive environmental graphics system (see Chapter 4)

Safety from flood waters is critical along the LA River. Flood channels within LA County are gated for public safety, so that access can be prohibited during flood conditions. Gates are to be placed at access points and major arterials and are to be connected to adjacent fencing. Vehicular and pedestrian gates must have the ability to close and lock. The design of new projects should maintain a level of safety while promoting a welcoming and connected open space river corridor.

## FENCE, GUARDRAIL, RAILING, AND GATE DEFINITIONS

**Fence:** A barrier for public safety along LA County watercourses at least 60 inches high off the adjacent surface.

**Guardrail:** A barrier at least 42 inches high near the open sides of elevated surfaces that minimizes the possibility of a fall. Guardrails should follow the latest code and ADA requirements (such as restrictions on openings).

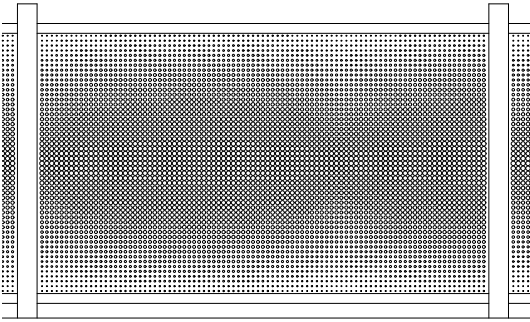
**Railing:** A barrier that separates trail uses or provides a visual separation but is not required by code.

**Gate:** An aperture along a fence to provide access while maintaining public safety.

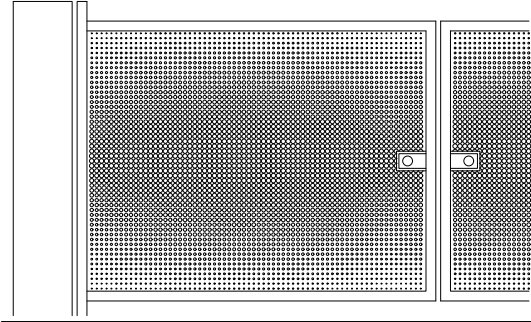
Figure 45. The terms above are defined as used in this document.

FENCE OR GUARDRAIL TYPOLOGIES

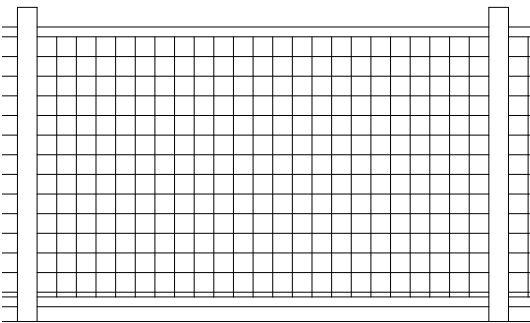
CORRESPONDING GATES



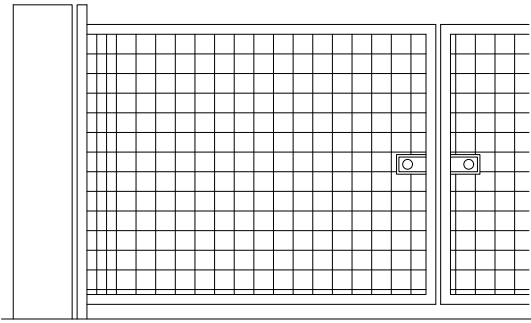
CUSTOM METAL



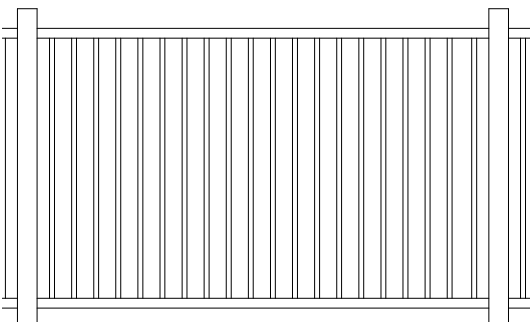
CUSTOM METAL GATE



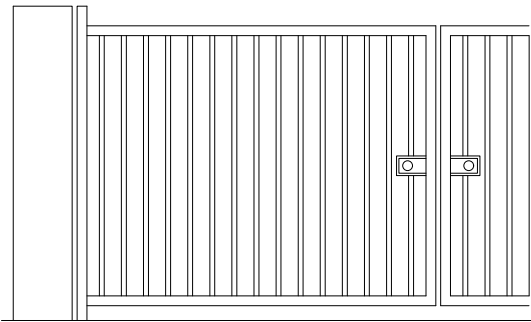
WELDED WIRE



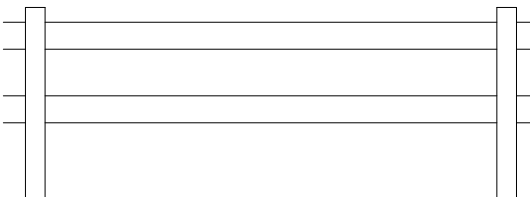
WELDED WIRE GATE



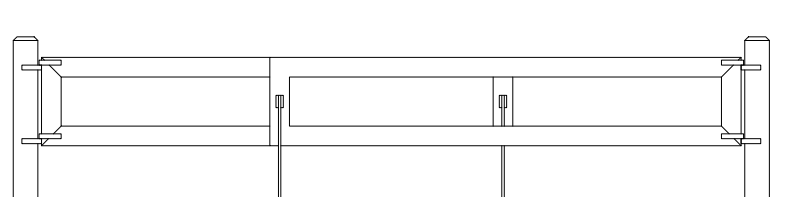
TUBULAR STEEL



TUBULAR STEEL GATE



LODGEPOLE SPLIT RAIL (FOR TRAIL SEPARATION)



EQUESTRIAN GATE

INCORPORATE FENCING THAT BLENDS IN WITH THE ENVIRONMENT WHERE POSSIBLE

Figure 46. Fence, guardrail, or gate type is determined by location on the river and the intended use.

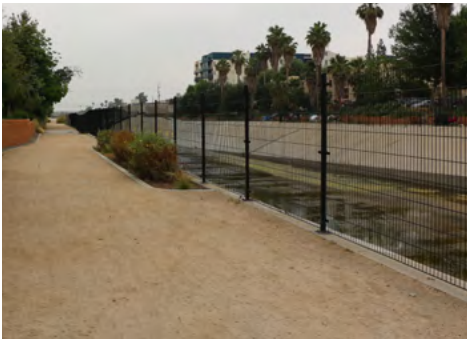


## FENCE EXAMPLES

## USED FOR



- Prominent trail access points
- Gateways
- Statement art piece



- Adjacent to channel
- Adjacent to parks



- Adjacent to channel
- Adjacent to parks



- Maintenance and service roads
- Equestrian trails
- Trail dividers

**MINIMIZE THE USE OF  
CHAINLINK FENCING AND DO NOT  
USE IN HIGH-VISIBILITY AREAS**

**Figure 47. Fence types along the LA River vary due to intended uses and adjacent elements.**  
Source: (Top) OLIN / Sahar Coston-Hardy, 2013. All other images OLIN, 2019.

GATEWAYS ARE PLACED ALONG  
THE RIVER AT KEY MOMENTS  
WHERE MAJOR ACCESS POINTS,  
ADJACENT PROGRAMMING, AND  
LA RIVER COMMUNITIES INTERSECT

---

## GATEWAYS

Gateways represent instances along the river to welcome, inform, and allow users to utilize the LA River Trail. They are access points at key moments along the river, and are usually identified by a visual marker, either through a large specimen tree, environmental graphics (see Chapter 4), or another kind of community artwork or cultural expression. Gateways call attention to the presence of the river and the access through their design and can also provide educational opportunities for visitors. While all gateways are access points, not all access points are gateways. Typically, gateways are placed along the river at moments where major access points, adjacent programming, and LA River communities intersect. Gateways represent a great opportunity to connect adjacent communities to the river and create a neighborhood identity based on the LA River.

There are three different scales of gateways that can be implemented depending on site conditions. All of the gateways must include the following items, no matter the type:

- Ample lighting for safety
- ADA accessibility
- Environmental graphics

### **Preferred**

Preferred gateways have a large or eye-catching visual marker and a gracious entrance (landside right-of-way larger than 17 feet). They include the most complete suite of amenities, including but not limited to, a Tier II or III river pavilion (see Chapter 6), environmental graphics (see Chapter 4), and native planting and specimen or shade trees (see Chapter 5).

### **Average**

Average gateways include a distinctive visual marker or artwork at its entrance and occur in areas that have a narrower landside right-of-way than the preferred gateways (approx. 12 feet-17 feet). These gateways can include a Tier I river pavilion (see: Chapter 6), artwork, stormwater BMPs, and a native vegetation buffer to designate the LA River access point.

### **Minimum**

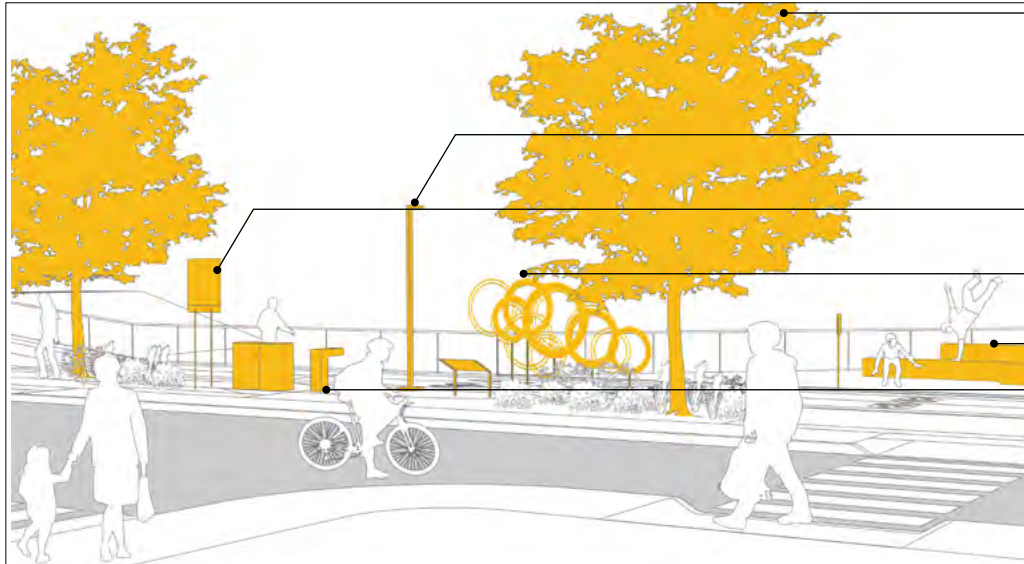
The minimum gateways provide an enhanced access point to the LA River in narrow landside right-of-way. Environmental graphics are often the primary visual markers for these gateways, and allow users to locate themselves on the river and educate themselves about different facets of the river. These gateways can also include site furnishings, stormwater BMPs, and a native vegetation buffer to welcome users to access the river.

**PREFERRED**



- RIVER PAVILION (SEE CH. 6)
- LIGHTING (SEE CH. 6)
- SITE FURNISHINGS (SEE CH. 6)
- ENVIRONMENTAL GRAPHICS (SEE CH. 4)
- EMERGENCY CALL BOX (SEE CH. 6)
- SPECIMEN SHADE TREE (SEE CH. 5)

**AVERAGE**



- SPECIMEN SHADE TREE (SEE CH. 5)
- LIGHTING (SEE CH. 6)
- ENVIRONMENTAL GRAPHICS (SEE CH. 4)
- COMMUNITY EXPRESSION - PUBLIC ART (SEE CH. 2)
- ART/PERFORMANCE SPACE (SEE CH. 6)
- SITE FURNISHINGS (SEE CH. 6)

**MINIMUM (NARROW)**



- SPECIMEN SHADE TREE (SEE CH. 5)
- LIGHTING (SEE CH. 6)
- ENVIRONMENTAL GRAPHICS (SEE CH. 4)
- SITE FURNISHINGS (SEE CH. 6)
- COMMUNITY EXPRESSION - PAVEMENT GRAPHICS (SEE CH. 4)

**Figure 48.** Gateway conditions vary depending on the space available. Gateways signify entrances to the LA River Trail and vary from trail access points with clear environmental graphics and minimum site-specific amenities to access points with pavilions and programming.

TRAIL INTERSECTIONS SHOULD BE  
CAREFULLY CONSIDERED IN THE  
DESIGN OF BRIDGES TO ENSURE  
SEAMLESS CIRCULATION BETWEEN  
DIFFERENT KINDS OF USERS

---

## BRIDGES

Connectivity across the LA River is just as important as connectivity along it. Where feasible, bridges should be implemented to connect all users to the river and the adjacent neighborhoods. While the overall look and structure of these bridges will be different based on the location and intended use, there are certain elements that should be present in all instances.

Ideally, a bridge would be able to connect all users of the LA River corridor, including habitats and animals. Where the construction or investment of a land bridge is not possible, equestrian, bicycle, and pedestrian trails should be connected across the river. At a minimum, bicycles and pedestrians should be able to cross to enjoy amenities and destinations along both sides of the river. Guardrail heights should follow the standards put forth in the applicable codes as stated in the LACFCD Permitting Checklist in Chapter 2.

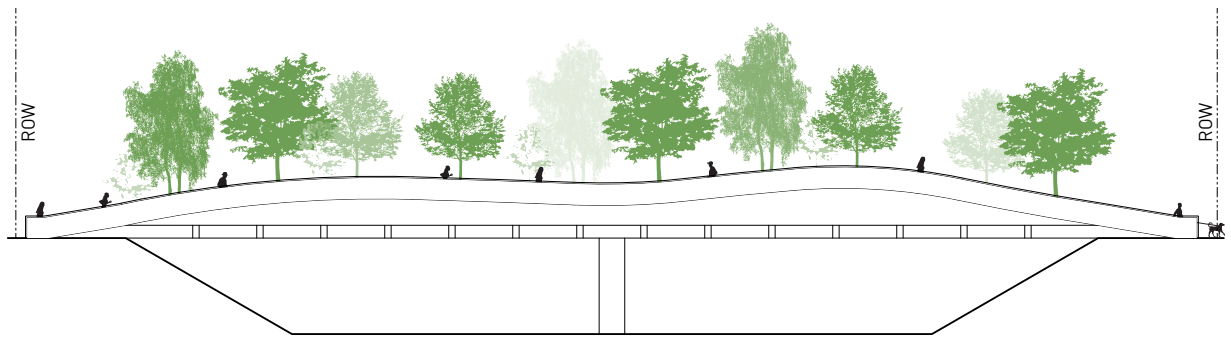
Wherever a bridge is implemented, connections to the correct trail systems and users is paramount. Trail intersections should be carefully considered in the design of bridges to ensure seamless circulation between different kinds of users. For example, when building an equestrian bridge, that bridge should connect users to a corresponding equestrian trail. In all instances of crossing, ample environmental graphics and striping must be included to warn users of a crossing. The specific design, materiality, and form of each bridge should be developed for intended use and on a project-by-project basis. Bridges also provide an opportunity for artwork.

All bridge proposals should be studied for hydraulic impacts on the flood capacity of the channel and shall aim to convey at a minimum the 1% annual chance flood event, including freeboard. Bridge height and width should also consider future climate and channel condition.



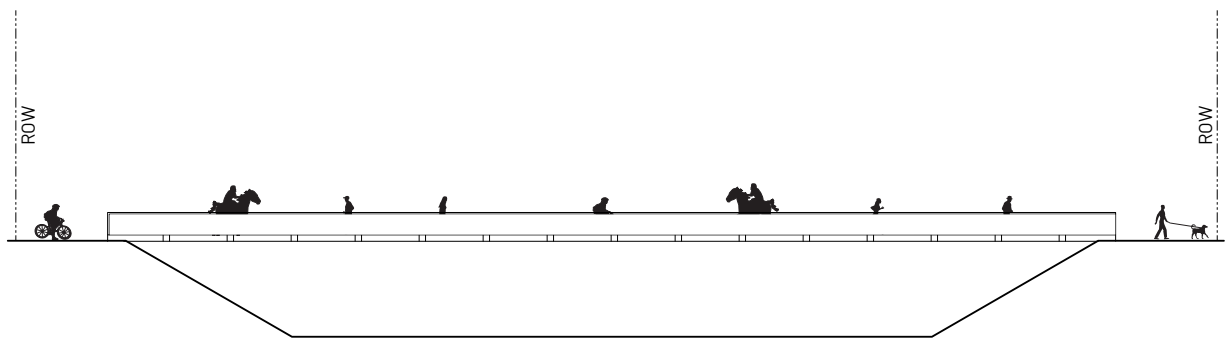
## BRIDGE TYPOLOGIES

PREFERRED



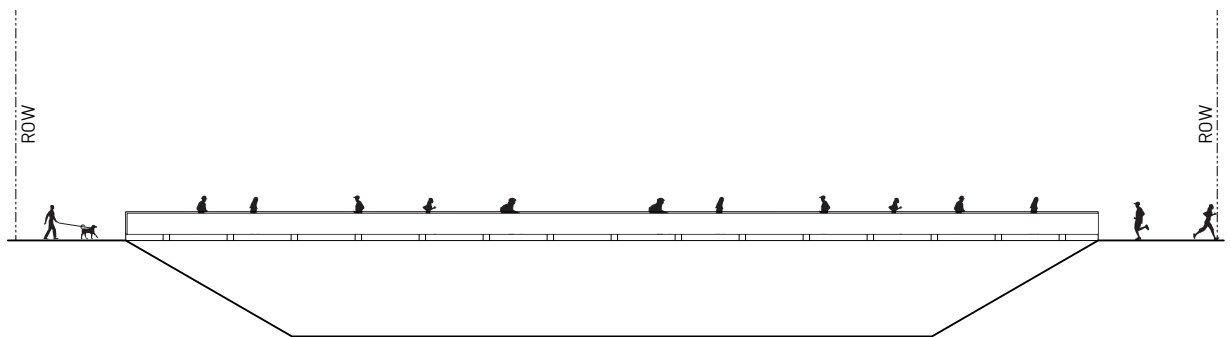
### LAND BRIDGE/HABITAT CONNECTIONS + MULTIUSE TRAIL BRIDGE

See Figure 50 on page 90.



### MULTIUSE TRAIL BRIDGE

See Figure 51 on page 90.

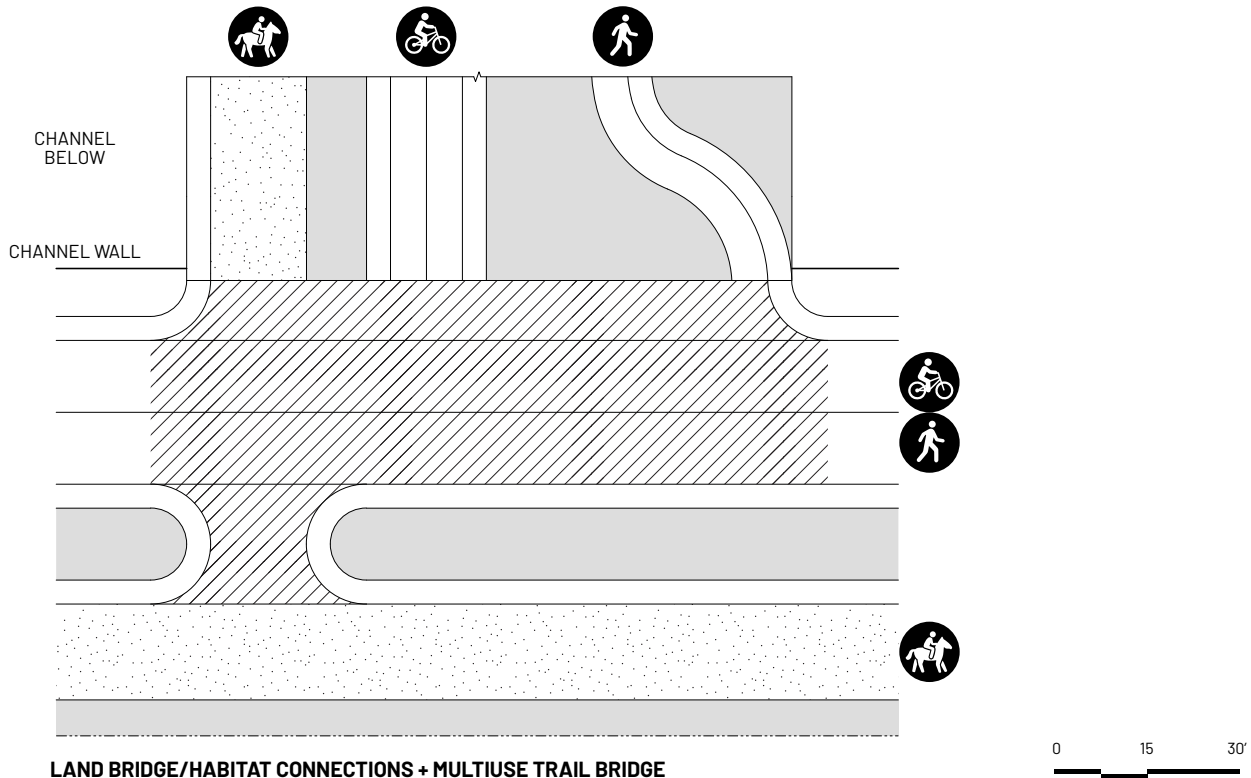


### PEDESTRIAN + BIKE TRAIL BRIDGE

See Figure 53 on page 91.

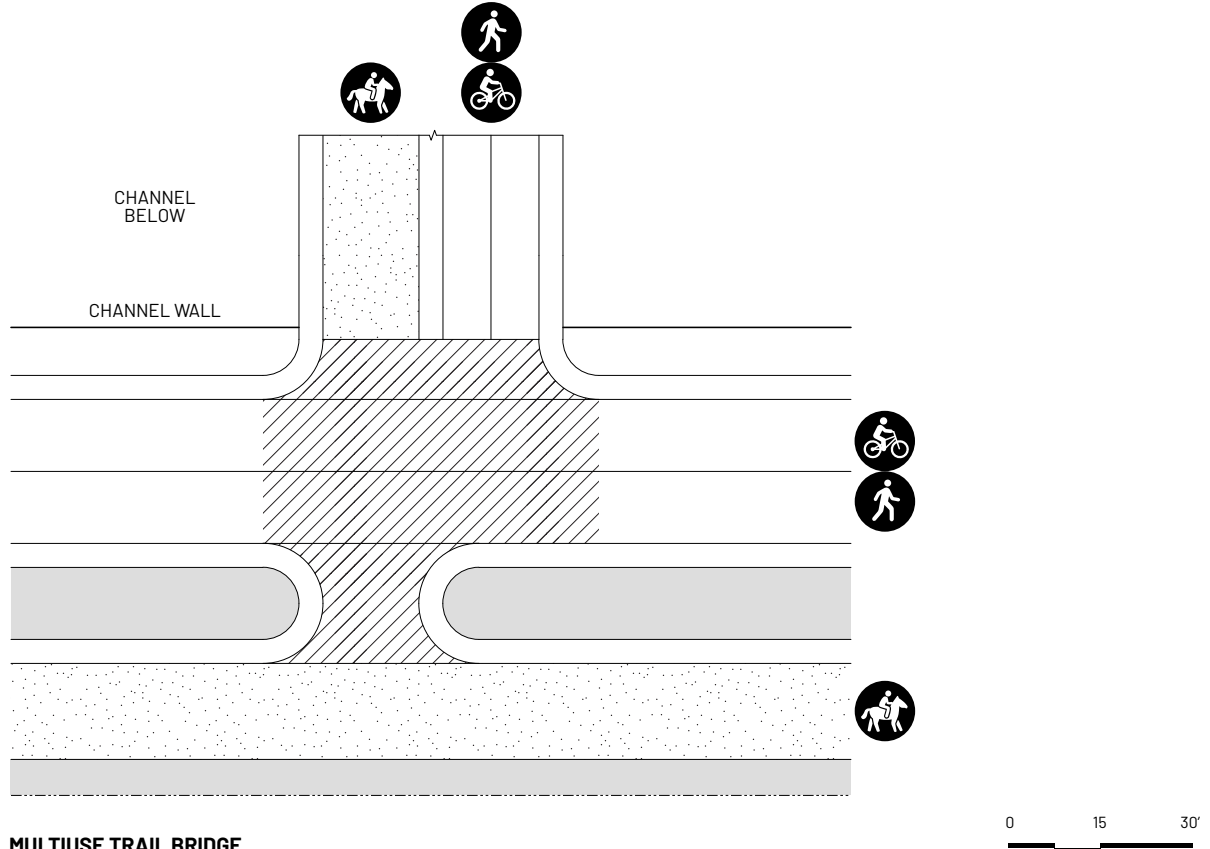
MINIMUM

Figure 49. Bridge crossings are unique to the use of the bridge. The design, materiality, and form of each bridge should be determined based on the intended use. All bridge proposals shall be studied for hydraulic impacts on the flood capacity of the channel.



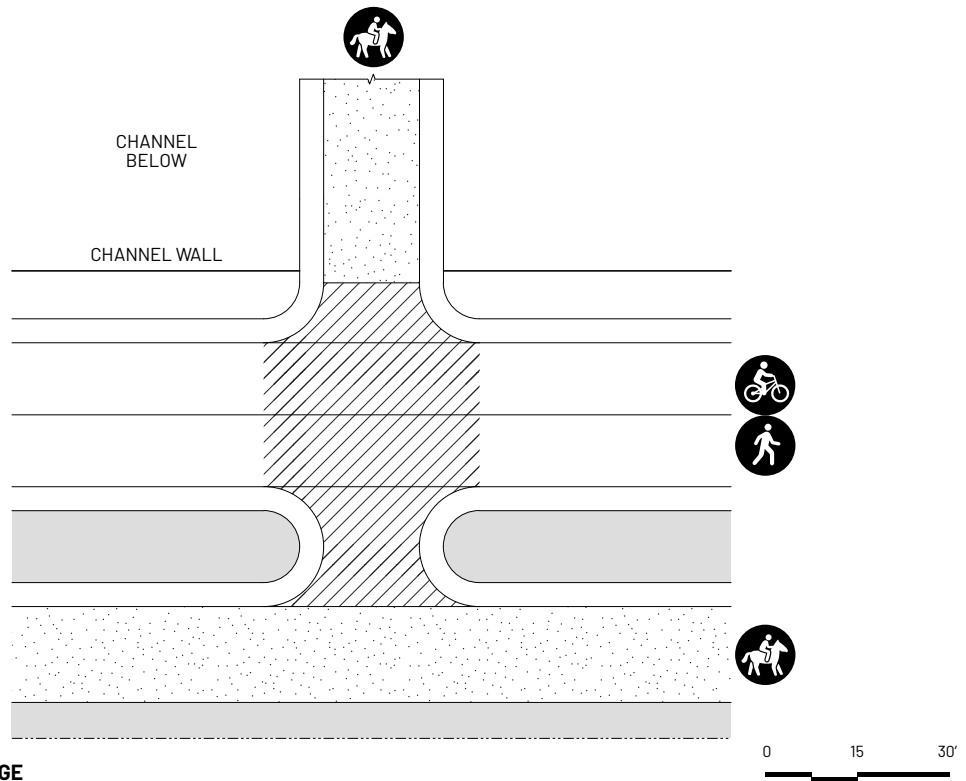
**LAND BRIDGE/HABITAT CONNECTIONS + MULTIUSE TRAIL BRIDGE**

Figure 50. Land bridges create habitat and movement opportunities through varied planting and topography. Pedestrian, bicycle, and equestrian paths should be a minimum of 12 feet wide between railings. When possible, slope bridge paths to a maximum of 5%. If sloped up to 8.33% or more, provide landings and railings as per ADA requirements for accessible ramps. Cross-slope should be a maximum of 2%. Use clear centerline striping and environmental graphics, developed with a project's specific needs, to warn trail users of a bridge crossing and provide a clear connection to equestrian trail.



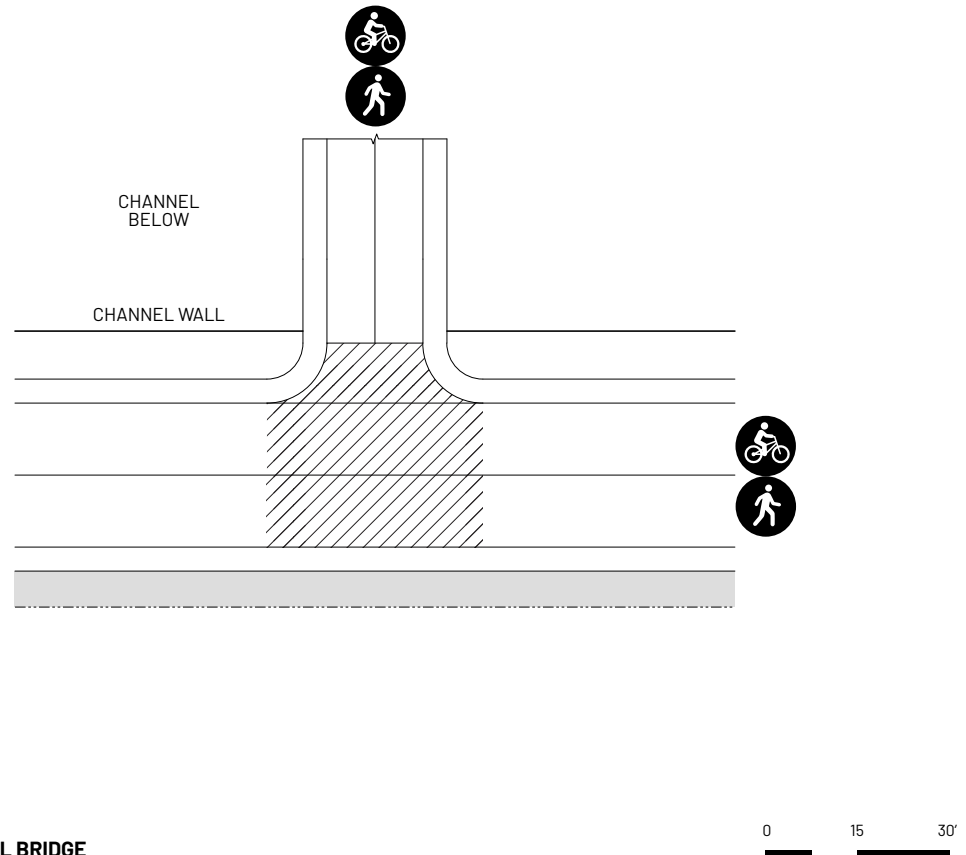
**MULTIUSE TRAIL BRIDGE**

Figure 51. Pedestrian, bicycle, and equestrian paths should be a minimum of 12 feet wide between railings. When possible, slope bridge paths to a maximum of 5%. If sloped up to 8.33% or more, provide landings and railings as per ADA requirements for accessible ramps. Cross-slope should be a maximum of 2%. Use clear centerline striping and environmental graphics, developed with a project's specific needs, to warn trail users of a bridge crossing and provide a clear connection to equestrian trail.



**EQUESTRIAN TRAIL BRIDGE**

Figure 52. Equestrian bridge to be a minimum of 12 feet wide between railings. When possible, slope equestrian bridge paths to a maximum of 5%. If sloped up to 8.33% or more, provide landings and railings as per ADA requirements for accessible ramps. Cross-slope should be a maximum of 2%. Use clear centerline striping and environmental graphics, developed with a project's specific needs, to warn trail users of a bridge crossing and provide a clear connection to equestrian trail.



**PEDESTRIAN + BIKE TRAIL BRIDGE**

Figure 53. Pedestrian and bicycle paths should be a minimum of 12 feet wide between railings. When possible, slope bridge paths to a maximum of 5%. If sloped up to 8.33% or more, provide landings and railings as per ADA requirements for accessible ramps. Cross-slope should be a maximum of 2%. Use clear centerline striping and environmental graphics, developed with a project's specific needs, to warn trail users of a bridge crossing.

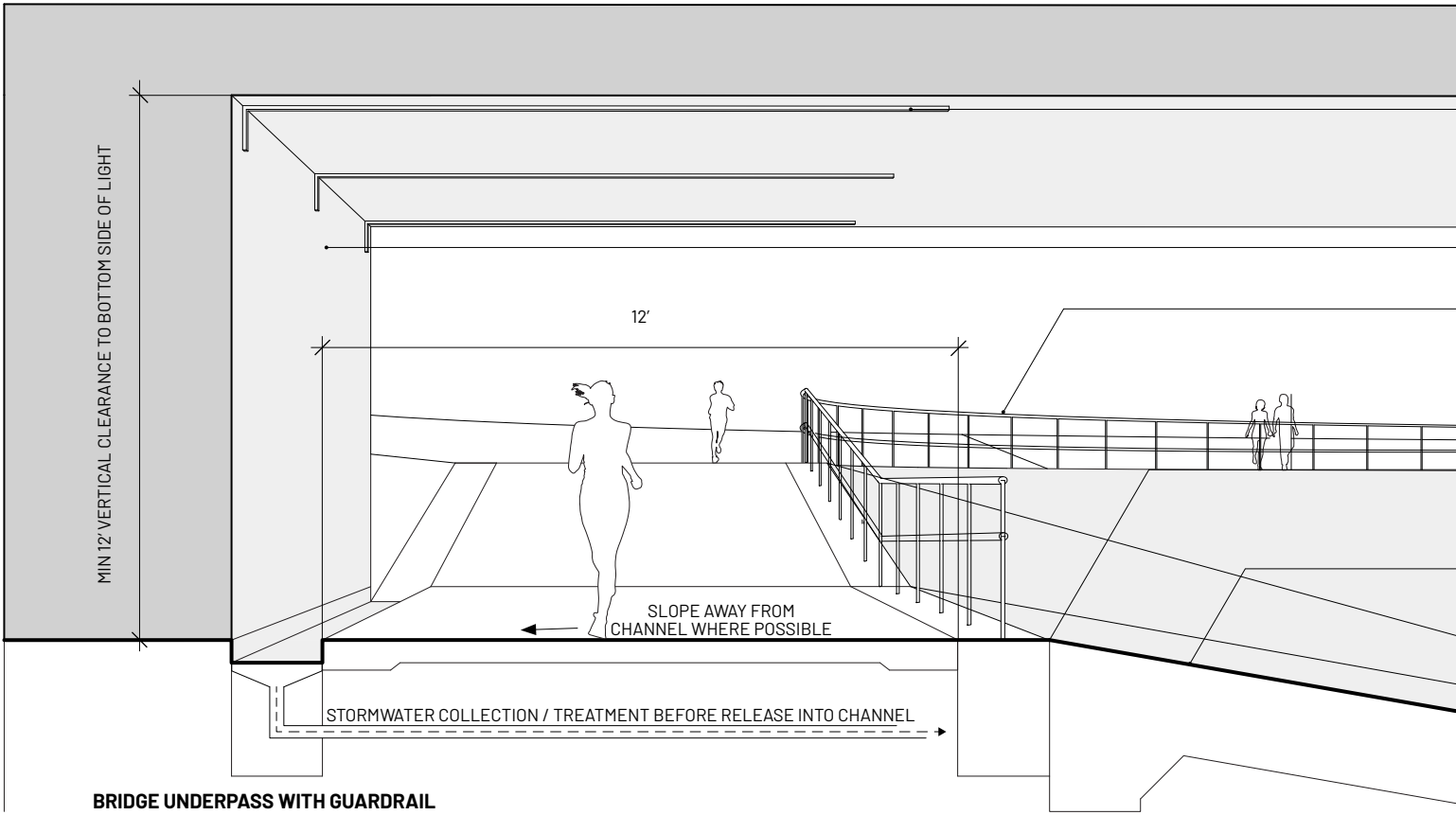
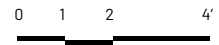
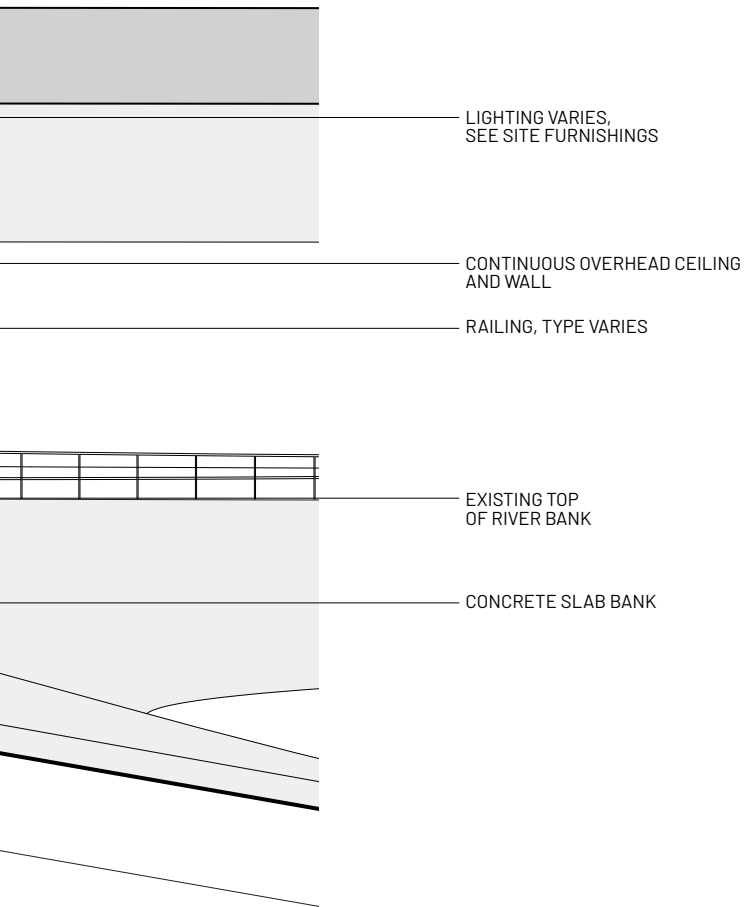


Figure 54. Lighting, safety, grading, and opportunities for art are key design considerations at underpass locations.





**THE SLOPE OF THE TRAIL AT ANY UNDERPASS OR OVERPASS SHOULD BE BETWEEN A MAXIMUM OF 5-8%, WITH LANDINGS PER ADA REQUIREMENTS**



## RIVER TRAIL BRIDGE UNDERPASS

Trails that run parallel to the river often pass under or over existing or proposed bridge crossings. At these crossings, the slope of the trail at any underpass or overpass should ideally be less than 5%, but no more than 8.33%. The trail should follow the standards outlined in the multiuse trails section. It may be necessary to separate users from the river with a guardrail depending on the riverside condition and local jurisdiction requirements. Ample lighting must be provided in all underpass conditions to ensure visibility and to create a safe trail experience. Opportunities for art can also be considered to create a bright and welcoming space. Where possible, stormwater treatment should be included so that the trail slopes away from the river so that any rainfall drains to a shallow gutter that runs along the bridge footing. This allows for water to be transferred to a treatment location before being released back into the river. Special consideration can be given for underpasses with tight right-of-way conditions.

All underpass conditions shall be designed with continuous surfaces, without notches above and on the side, to prohibit the use of the spaces between structural members.

# ACCESS AND MOBILITY CHECKLIST

Reference the LACFCD and Public Works Permitting checklist on page 36 for an overview of project permitting and applicable codes.

## Detailed Technical Requirements Checklist for Access and Mobility

### Trail Assembly

- Connect all trails to the LA River trail system as outlined in the LA River Master Plan Update.
- Slope all trails at a maximum of 2% away from the river to encourage runoff collection.
- Slope all trails, where feasible, into a vegetated area that is designed to collect, retain, and infiltrate stormwater runoff.

### Paving

- Do not use dark surfacing, such as black asphalt, along the trail as it intensifies the urban heat island effect.
- Only use low VOC, warm mix asphalt when asphalt surfacing is specified.

### Fences and Gates

- Use the correct type of fence, guardrail, or railing for the location.
- Where possible, do not use chain link fencing anywhere on the river. Chain link fencing should not be used in highly-visible areas.
- Treat all metal fencing with corrosion-resistant coatings such as powder coating. Special attention should be paid to mitigate zinc-leaching materials.

### Access Points

- All access points must have the following:
  - Lighting (see Chapter 6).
  - Environmental graphics (see Chapter 4).
- Where feasible, add or relocate bus stops to existing or proposed river trail access points.

### Gateways

- All gateways must have the following:
  - Lighting (see Chapter 6).
  - ADA access
  - Environmental graphics (see Chapter 4).
- Tier III gateways should include the following:
  - Vegetation buffer.
  - Community expression or art.
  - River Pavilion (see Chapter 6).

## **Bridges**

- Bridges should be a minimum of 8 feet wide.
- Slope bridge path up to a maximum of 5% on main paths.
- Use environmental graphics to warn users of trail and bridge intersections.
- Connect bridge paths of travels to appropriate multiuse trails. (For example, connect equestrian bridges to adjacent equestrian trails.)

## **Underpasses**

- Allow a minimum 10-foot clearance at underpasses.
- Add lighting to ensure visibility.
- Design smooth straight surfaces along underpasses, without notches, to prohibit the use of the spaces between structural members.
- Add art or community expression to underpass walls (if required).

## **Detailed Maintenance Program Checklist for Access and Mobility**

### **Paving**

- Inspect paving on a regular schedule for cracks, potholes, or erosion.

### **Fences and Gates**

- Inspect fencing and guardrails for vandalism or weathering.
- Reduce use of fencing and deploy only where necessary for safety.

### **Gateways, Bridges, and Underpasses**

- Identify inspection requirements for gateways, bridges, or underpasses.
- Treat materials to deter graffiti and vandalism.



Figure 55. Environmental graphics help to define river gateways, as shown in this Pavilion example at river mile 14.7.



# 4.

## ENVIRONMENTAL GRAPHICS

### ENVIRONMENTAL GRAPHICS ALONG THE RIVER PROMOTE ACCESSIBILITY, SAFETY, AND COMMUNITY EXPRESSION

The Environmental Graphics Guidelines for the LA River Master Plan Design Guidelines have been developed with a common set of values for their design and proposed use. These guidelines create a framework for consistent wayfinding and promote a unique identity for the LA River. They aim to be accessible to all. Legibility and graphic clarity are critical for the success of all wayfinding elements. The sign designs detailed in this chapter have a simple, timeless aesthetic while allowing for community expression and art at gateways and other special instances. Environmental graphics can be integrated, where appropriate, into the design of architecture and public art rather than consisting exclusively of stand-alone signs. Wayfinding from bike routes and pedestrian streets is also crucial for directing people to the river itself. The programmed sequence, placement, and content of information conveyed through wayfinding elements should be carefully calibrated using established environmental graphic design 'best practices' to optimize clarity and avoid visual clutter as pedestrians or cyclists approach and enter the LA River right-of-way.



# WHAT'S IN THE CHAPTER

There are eight categories of environmental graphics: Informational, Regulatory, Confirmation, Interpretive signs and displays, Directional, River Mile Markers, River Mile Pavement Markings, and Large Scale Icon Graphics. This chapter includes a suite of LA River environmental graphics which outlines which categories are required at a minimum for different scales of projects (XS-XL, as defined in the Chapter 1 programming section and the LA River Master Plan Update) at various distances leading to and within the site. Further, there is a permitting matrix that identifies what features each category should or should not have, such as which environmental graphics should always be bilingual.

Wayfinding signs must comply with the Federal Highway Administration's Manual on Uniform Traffic Control Devices (MUTCD) guidelines. All River Mile Markers must use the 51-mile river mile numbering system with the mouth at river mile 0, and the headwaters at river mile 51.

<b>97</b>	<b>4. Environmental Graphics</b>
98	What's in the Chapter
100	Standard Design Features
105	Sequence and Placement of Environmental Graphics
113	Suite of LA River Environmental Graphics
118	Informational
121	Regulatory
126	Confirmation
131	Interpretive
136	Directional
145	River Mile Markers
147	River Mile Pavement Markings
148	River Mile Marker and Pavement Marking Placement
151	Large Scale Icon Graphics
152	Community Expression
154	Installation & Maintenance
158	Environmental Graphics Checklist

**Coloring and Stroke**

Use the color and stroke for the LA River that is shown in the legend. Always follow the standard color and stroke for the LA River. The color and stroke for the LA River is shown in the legend. Always follow the standard color and stroke for the LA River. The color and stroke for the LA River is shown in the legend. Always follow the standard color and stroke for the LA River.

**LINE WEIGHTS**

Use the line weight for the LA River that is shown in the legend. Always follow the standard line weight for the LA River. The line weight for the LA River is shown in the legend. Always follow the standard line weight for the LA River.

**Font**

Use the font for the LA River that is shown in the legend. Always follow the standard font for the LA River. The font for the LA River is shown in the legend. Always follow the standard font for the LA River.

**Color**

Use the color for the LA River that is shown in the legend. Always follow the standard color for the LA River. The color for the LA River is shown in the legend. Always follow the standard color for the LA River.

**BAR/IN STYLES**

THIN  
 TWELFTH  
 EXTRA-LIGHT  
 EXTRA-LIGHT ITALIC  
 LIGHT  
 LIGHT ITALIC  
 REGULAR  
 REGULAR ITALIC  
 MEDIUM  
 MEDIUM ITALIC  
 SEMI-BOLD  
 SEMI-BOLD ITALIC  
 BOLD  
 BOLD ITALIC  
 EXTRA-BOLD  
 EXTRA-BOLD ITALIC  
 BLACK  
 BLACK ITALIC

**FONT SIZE**

12pt  
 14pt  
 16pt  
 18pt  
 20pt  
 24pt  
 30pt  
 36pt  
 48pt  
 60pt  
 72pt

**STANDARD FONT SIZE GUIDE**

12pt  
 14pt  
 16pt  
 18pt  
 20pt  
 24pt  
 30pt  
 36pt  
 48pt  
 60pt  
 72pt

**LA RIVER**

**ARTERIAL ROAD ENVIRONMENTAL GRAPHICS**

Use the environmental graphics for the LA River that is shown in the legend. Always follow the standard environmental graphics for the LA River. The environmental graphics for the LA River is shown in the legend. Always follow the standard environmental graphics for the LA River.

**BIWAY ENVIRONMENTAL GRAPHICS**

Use the environmental graphics for the LA River that is shown in the legend. Always follow the standard environmental graphics for the LA River. The environmental graphics for the LA River is shown in the legend. Always follow the standard environmental graphics for the LA River.

**SITE OF A RIVER ENVIRONMENTAL GRAPHICS**

Use the environmental graphics for the LA River that is shown in the legend. Always follow the standard environmental graphics for the LA River. The environmental graphics for the LA River is shown in the legend. Always follow the standard environmental graphics for the LA River.

**INFORMATIONAL - OPTION 2 SIGN WITH BOTTOM PANEL**

**LA RIVER**  
**RICHARD LILLARD**  
**OUTDOOR CLASSROOM**

**REGULATORY**

**PURPOSE**

**PLACEMENT**

**RIVER MILE PAVEMENT MARKINGS**

Use the pavement markings for the LA River that is shown in the legend. Always follow the standard pavement markings for the LA River. The pavement markings for the LA River is shown in the legend. Always follow the standard pavement markings for the LA River.

**RIVER MILE PAVEMENT MARKINGS**

**PURPOSE**

**PLACEMENT**

**PAVEMENT MARKING GUIDE**

**WHITE MARKS**

**PAVEMENT MARKING GUIDE**

**WHITE MARKS**

Figure 56. Chapter 4 of this document covers items related to environmental graphics that are present on and along the LA River.

# STANDARD DESIGN FEATURES

All environmental graphics share common design features such as the terminology for the “LA River,” the heron logo and icon, the use of open-source Barlow font, and the recommended high contrast background to text color ratio. Accessibility, legibility, and compliance with the American with Disabilities Act (ADA) are baseline criteria to be followed by environmental graphics. Further, symbols for amenities or trails should be consistent across all environmental graphics, and should be an MUTCD symbol if one exists for the amenity depicted.

## ACCESSIBILITY

Various best practices guide the suite of environmental graphics to make them legible and meaningful to all users along the LA River. It is important to consider the design of multi-modal environmental graphics. Designs that engage only one sense, such as sight, limit the audience’s experience. Best practices for accessible design consider the ranges of eyesight, hearing, touch, and cognition, for example, difficulty with distinguishing sounds from background noises or difficulty focusing or staying on task.

The inclusion of braille or audio components is encouraged and should be considered on a project by project basis. Several different strategies and technologies include audio signals and cues, ranging from powered boxes with buttons to QR codes. The specific approach should be developed with what makes sense for the project, depending on the context and type of environmental graphics to be installed.

### Americans with Disabilities Act (ADA) Sign Guidelines

ADA requirements generally apply to environmental graphics along routes that are designated as a path of travel. It is important to reference the latest ADA requirements as they are updated over time.

ADA requirements for the minimum type size on a sign are determined by how high the sign is located off the ground and how close a viewer can approach and read it. For example, if a sign is located between 40 inches and 70 inches off the ground, and the viewer can approach within 6 feet of it, the minimum size of the type, which is based on the height of a capital letter “I”, should be 5/8 inch. For every additional foot beyond 6

feet that a viewer cannot approach the sign, the size of the font needs to increase by 1/8 inch. Visual characters should not be any lower than 40 inches from the ground. ADA requirements for single or double posts for freestanding signs depends on the placement of the sign along a path of travel, the height it is located, and the amount the sign overhangs each post. For example, a sign that has overhangs a single post more than 12 inches should have two posts and be located a maximum of 27 inches or a minimum of 80 inches off the ground.<sup>16</sup> Always check the latest requirements.

### Language

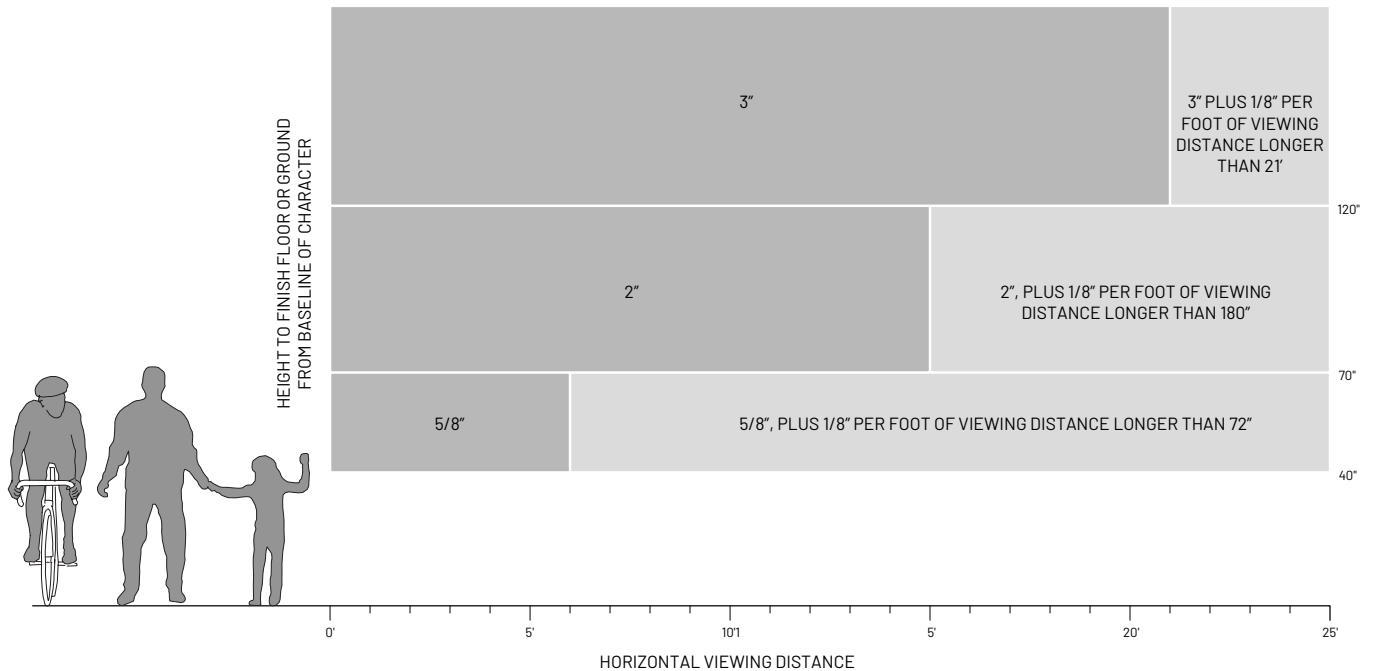
The LA River travels through many diverse neighborhoods. Primary languages spoken by adjacent neighborhoods must be considered when creating bilingual environmental graphics. Languages such as, but not limited to, Spanish, Chinese, Khmer, Tagalog, Russian, or Korean are all examples of languages that can be used for translations of environmental graphics. Symbols and clear graphic design can also be used for communication without the need for translations. The following should be considered for bilingual signs:

- In order to better differentiate between different languages on the same sign, varying text weights is recommended. In some cases, English text will appear in bold, with the translated text at a thinner font weight either next to or below the English text. This will help the viewer to more easily and quickly digest the content that is intended for them.
- Translated text should appear in the same font and color of the English text. Where non-Latin fonts are used, choose a font that is clear and simple with no serif or no stylistic modifications (Google Noto Fonts is recommended and available for free in over 75 non-Latin languages).
- Translations should be proofread by native speakers of the language and/or community members before use.
- Translations should always appear on the same sign as the English text.
- Where feasible, use standardized or universal symbols to communicate without the need for text translations.

## Contrast and Color

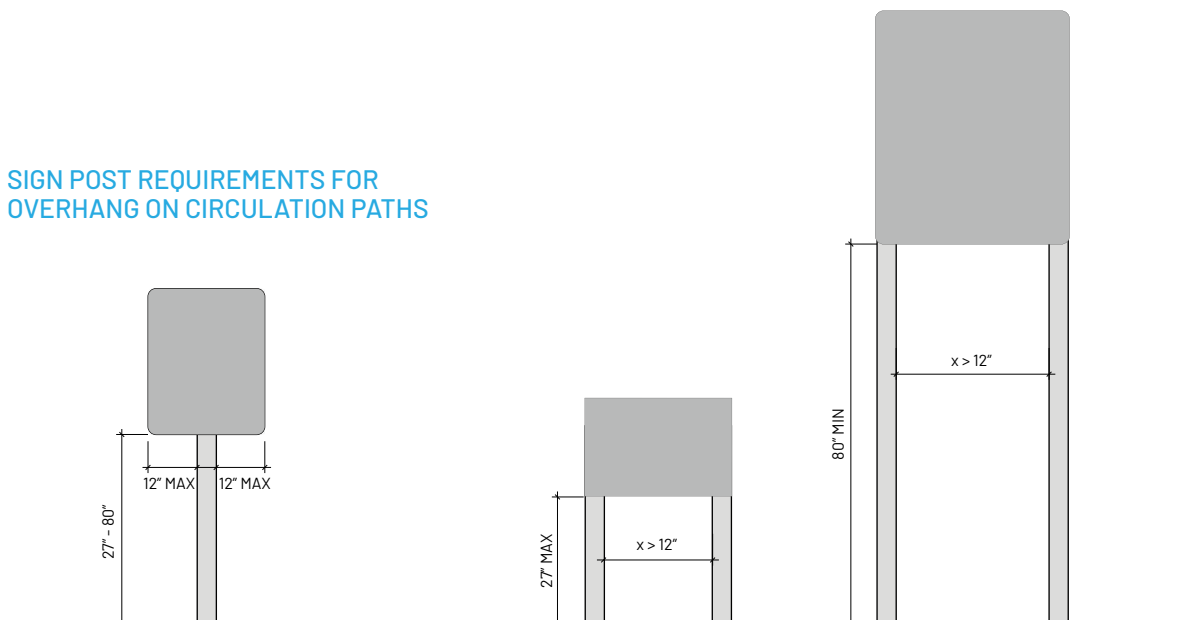
Many individuals experience color differently, and the least variance in human perception of color is in tonal contrast. Maintaining sufficient tonal contrast is important for accessible communication of information in environmental graphics.<sup>17</sup> See page 103 for the required background color (to be used against white) and for the recommended contrast ratio.

## CHARACTER HEIGHT REQUIREMENTS



**Figure 57.** Character height required for ADA accessibility is based on horizontal viewing distance. Designers should check the latest ADA standards for updates. Source: Standards from U.S. Department of Justice. (2010). 2010 ADA Standards for Accessible Design. Washington, DC: U.S. Department of Justice.

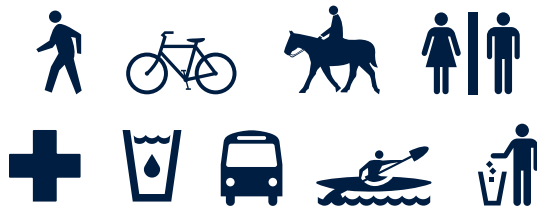
## SIGN POST REQUIREMENTS FOR OVERHANG ON CIRCULATION PATHS



**Figure 58.** Single or double posts are required for signs directly overhanging on circulation paths depending on the height they are located and the amount of sign protruding beyond the post. Designers should check the latest ADA standards for updates. Source: Standards from U.S. Department of Justice. (2010). 2010 ADA Standards for Accessible Design. Washington, DC: U.S. Department of Justice.

## Symbols and Arrows

For consistency, arrows and symbols for trail use or other amenities should follow the symbols used by Federal Highway Administration’s Manual on Uniform Traffic Control Devices (MUTCD). Reference the latest MUTCD documents as updates are incorporated over time. In cases where the symbol needed is not available from MUTCD, a new symbol can be designed but should be similar in style and weight as MUTCD symbols. The use of arrows should communicate the direct path of travel when facing the signs. Only up (straight ahead), left, and right arrows should be used. Careful consideration of the placement of each sign in regard to a user’s path of travel is important. Down arrows should not be used to indicate something is behind the user, rather the signs should be moved to a location where the destination is in front of, or to the left or right, of the sign user.



**Figure 59.** MUTCD symbols, for example ones for pedestrians, cyclists, equestrians, restrooms, first aid, drinking water, bus stop, kayaking, and litter receptacle, should be used on signs where possible. Source: 2009 MUTCD Edition with Revisions 1 and 2, 2012.

## Icon and Logo

To reinforce an identity for the LA River, the heron graphic and icon should be used consistently. The icon of the heron on a riverbank within a circle should be used wherever a logo for the LA River is needed. This is useful when many logos are aligned in a row, or where there is limited space on a sign. The heron graphic is suited for large scale environmental graphics and other identifying environmental graphics, such as Informational signs.

Additionally, the term “LA River” is to be used on all environmental graphics instead of “Los Angeles River” or “L.A. River.”



**Figure 62.** When a symbol is needed that is not available from MUTCD, another symbol in a similar style and weight to MUTCD standards should be used. Examples include of symbols for gender-neutral restrooms, river crossings, a river confluence, and wetlands. Source: (Left) Title 24 of the California Code of Regulations, California Building Code, 2016; all other symbols, River LA.



**Figure 60.** The heron icon should be used when a logo for the LA River is needed, such as on a sign. Source: Edited for the LA River Master Plan, 2020 from the LA River Sign Guidelines, 2003.



**Figure 63.** The heron graphic should be used for large scale environmental graphics or other identifying environmental graphics. Source: LA River Master Plan, 2020.

# LA RIVER

**Figure 61.** The terminology and font on all environmental graphics should be “LA River” in Barlow.



### Font

All fonts to be used in the LA River Environmental Graphics should be Barlow, an open-source font. Exceptions are allowed for Large Scale Icon Graphics and other artwork. While Barlow does offer a wide range of different styles, semi-bold through black thicknesses offer the easiest readability and are the recommended styles.

### Colors

White and Pantone 282 C are the primary colors of all signage and environmental graphics in the LA River guidelines. The color contrast between the selected blue and white is 16:1, well above the suggested minimum of 7:1. Color matching of Pantone 282 C across all fabrication is the responsibility of the fabricator, and is important to maintain consistency through the whole suite.

## BARLOW STYLES

THIN

*THIN ITALIC*

EXTRA-LIGHT

*EXTRA-LIGHT ITALIC*

LIGHT

*LIGHT ITALIC*

REGULAR

*REGULAR ITALIC*

MEDIUM

*MEDIUM ITALIC*

**SEMI-BOLD**

***SEMI-BOLD ITALIC***

**BOLD**

***BOLD ITALIC***

**EXTRA-BOLD**

***EXTRA-BOLD ITALIC***

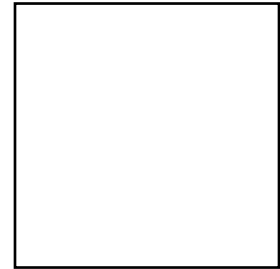
**BLACK**

***BLACK ITALIC***

## PANTONE 282 C



## WHITE



## STANDARD FEATURES OVERVIEW

- Background Color: Pantone 282 C and white
- Font: Barlow
- Contrast Ratio: 7:1 minimum
- Heron: Use required icon for logos. Use required graphic for other environmental graphics
- Symbols: Use MUTCD symbols where one exists
- Nomenclature: Always use "LA River"

Figure 64. Barlow is an open-source typeface designed by Jeremy Tribby and is available from Google Fonts. "Semi-bold" through "black" thicknesses are recommended for environmental graphics intended to be read from a distance or while traveling at a fast speed.

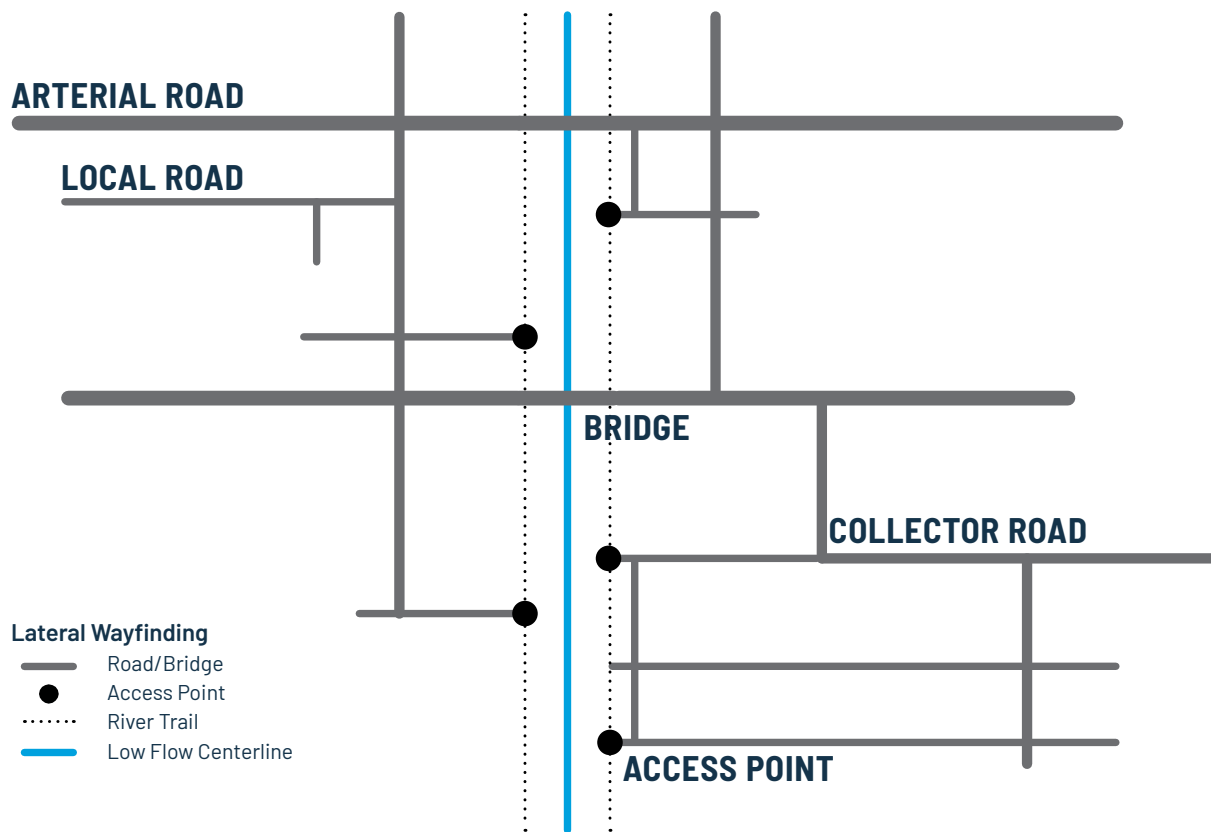


Figure 65. The approach to the placement and sequence of environmental graphics depends on the context and expected volume and speed of users passing by. The diagram above shows an abstraction of different contexts for environmental graphics leading to and along the LA River. Example scenarios are depicted on the pages that follow.

## **SEQUENCE AND PLACEMENT OF ENVIRONMENTAL GRAPHICS**

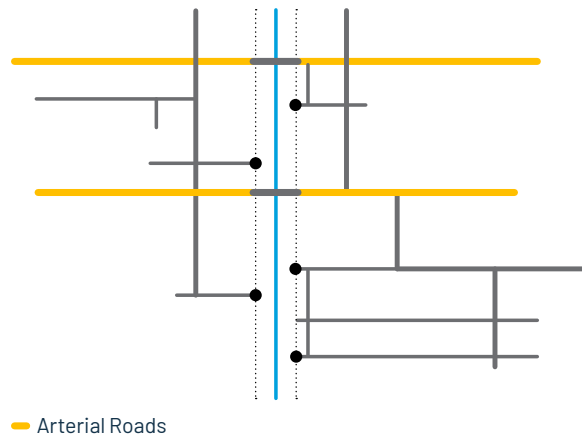
Lateral wayfinding is crucial in showing users how to navigate to the LA River, and clear placement of signs at gateways and along the trail notify users without being overwhelming. The vignettes on the following pages show examples of environmental graphics sequence and placement in typical contexts leading to and along the river. Directional environmental graphics should be placed so they are visible to pedestrians, bicyclists, those in vehicles, and equestrians where appropriate. These environmental graphics should be placed along a safe route that directs pedestrians and cyclists to the nearest access point. Informational, Regulatory, and other categories of signage should be placed in a clear manner at access points and along trails to avoid sign clutter.



Figure 66. Environmental graphics along arterial roads should guide users across busy intersections.

## ARTERIAL ROAD ENVIRONMENTAL GRAPHICS

- Per MUTCD\*, do not place wayfinding along freeways and expressways.
- Per MUTCD\*, do not place wayfinding in a location that competes visually with standard traffic signs.
- Use existing posts and traffic light posts where possible.
- At large pedestrian intersections, combine wayfinding with large totems at corners to avoid sign clutter.
- Apply Directional signs with existing bike lanes and pavement markings where applicable.
- Direct users to the nearest access point along a safe and accessible path.



— Arterial Roads

\*Reference the most current MUTCD standards.

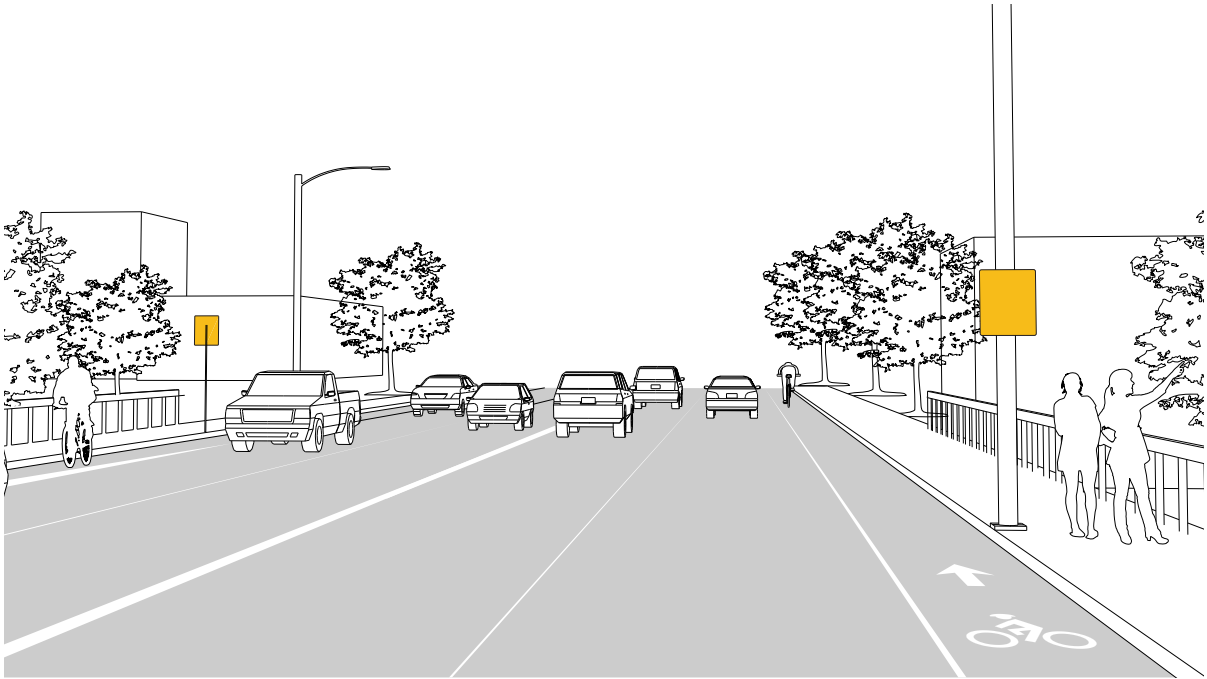
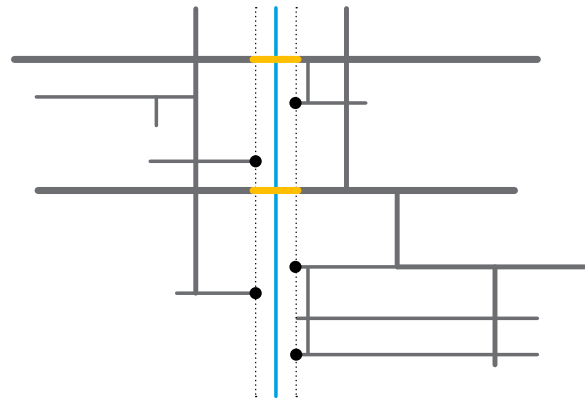


Figure 67. Environmental graphics along vehicular bridges alert drivers to the presence of the LA River.

## BRIDGE ENVIRONMENTAL GRAPHICS

- Per MUTCD\*, do not place wayfinding along freeways and expressways.
- Per MUTCD\*, do not place wayfinding in a location that competes visually with standard traffic signs.
- Use existing posts and traffic light posts where possible.
- Apply Confirmation signs that the bridge is crossing the LA River, isolated from other traffic signs.



— Bridges

\*Reference the most current MUTCD standards.

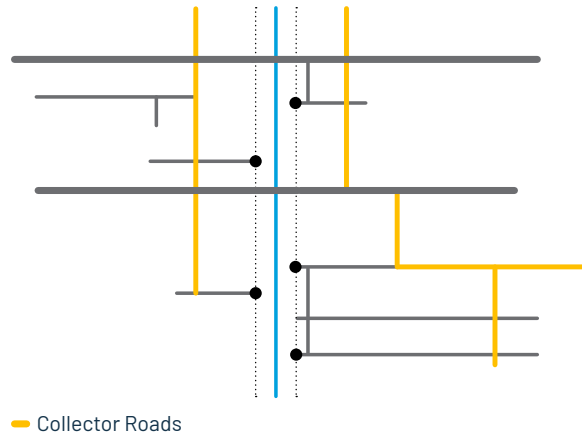




Figure 68. Environmental graphics along collector roads guide users towards the river and also allow for community expression.

## COLLECTOR ROAD ENVIRONMENTAL GRAPHICS

- Per MUTCD\*, do not place wayfinding along freeways and expressways.
- Per MUTCD\*, do not place wayfinding in a location that competes visually with standard traffic signs.
- Use existing posts and traffic light posts where possible.
- At large pedestrian intersections, combine wayfinding with large totems at corners to avoid sign clutter.
- Apply Directional signs with existing bike lanes and pavement markings where applicable.
- Direct users to the nearest access point along a safe and accessible path.



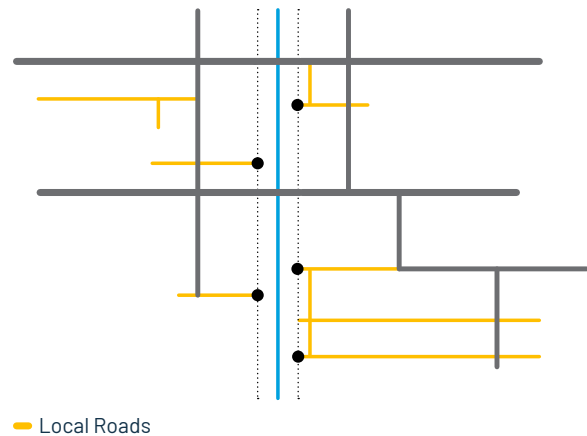
\*Reference the most current MUTCD standards.



Figure 69. Environmental graphics along local roads guide users through residential areas.

## LOCAL ROAD ENVIRONMENTAL GRAPHICS

- Per MUTCD\*, do not place wayfinding along freeways and expressways.
- Per MUTCD\*, do not place wayfinding in a location that competes visually with standard traffic signs.
- Use existing posts and traffic light posts where possible.
- Apply Directional signs with existing bike lanes and pavement markings where applicable.
- Direct users to the nearest access point along a safe and accessible path.
- Environmental graphics placement should be sensitive to context. In residential areas, place signs in the public right-of-way and minimize environmental graphics as needed.



\*Reference the most current MUTCD standards.

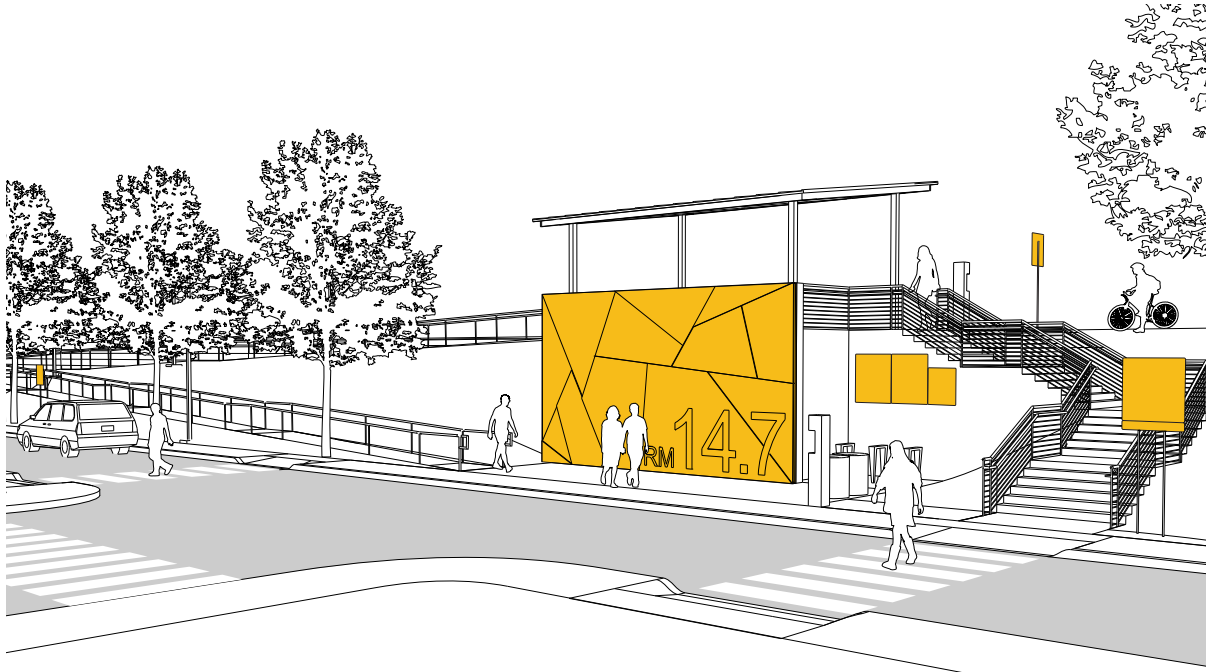
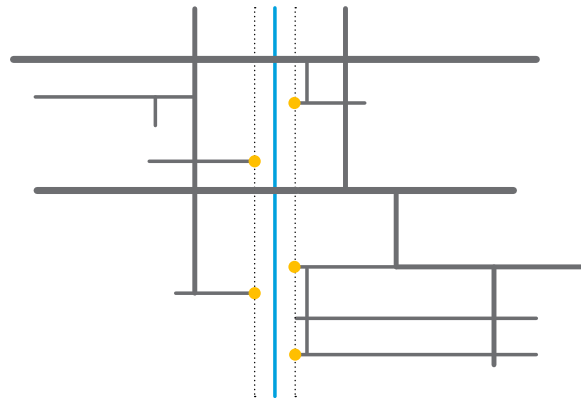


Figure 70. Environmental graphics at gateways should avoid sign clutter.

## ACCESS POINT ENVIRONMENTAL GRAPHICS

- Place one Informational sign at the main entry of each access point.
- Place Regulatory “Park Rules” sign further back, alongside River Pavilion, trail, or other amenities.
- Apply Regulatory Warning and Safety environmental graphics along channel at regular intervals.
- Use Environmental graphics for neighborhood expression.



● Access Points

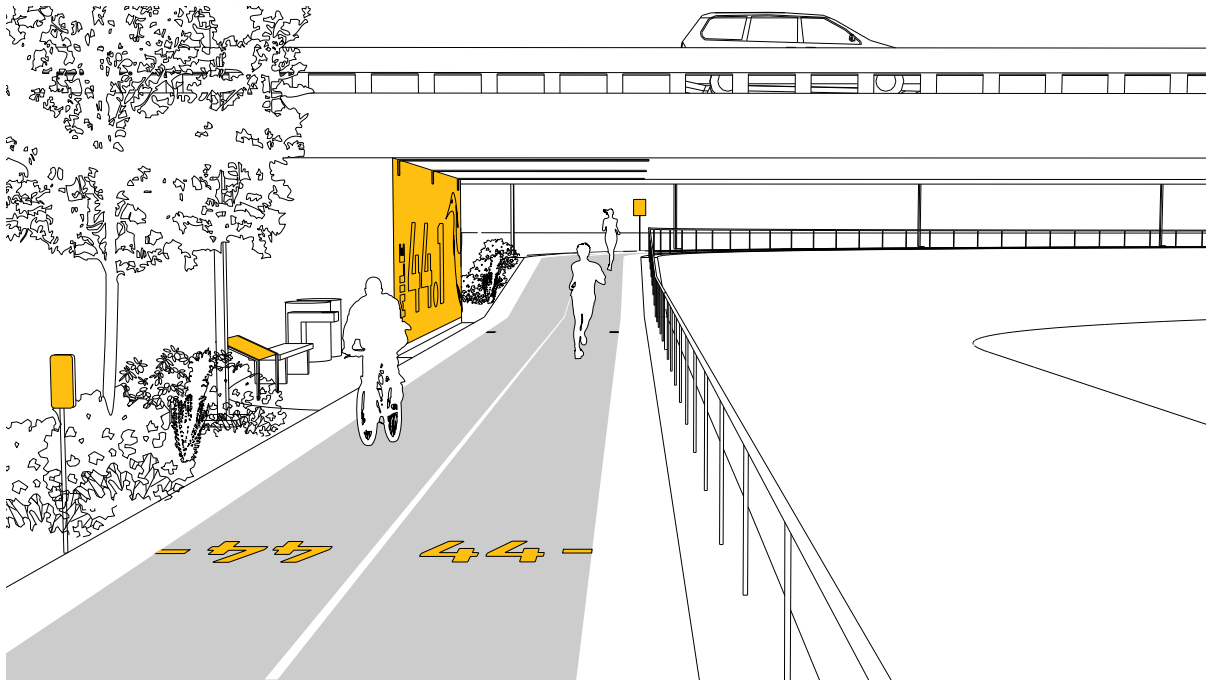
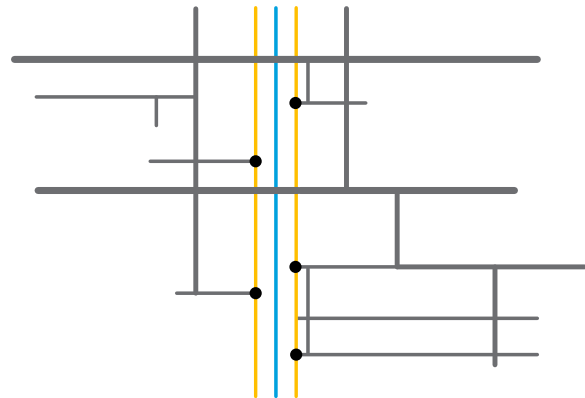


Figure 71. Environmental graphics along the LA River help locate and inform trail users.

## TRAIL ENVIRONMENTAL GRAPHICS

- Place River Mile Marker signs every .5 miles along river.
- Place River Mile Pavement Markings every river mile along river.
- River Mile ticks without mile numbers should appear every tenth of a mile along river.
- Place Confirmation signs as needed along the trail (at least every 2 miles).
- Use environmental graphics for trail underpasses and bare walls along the trail.



— Trails

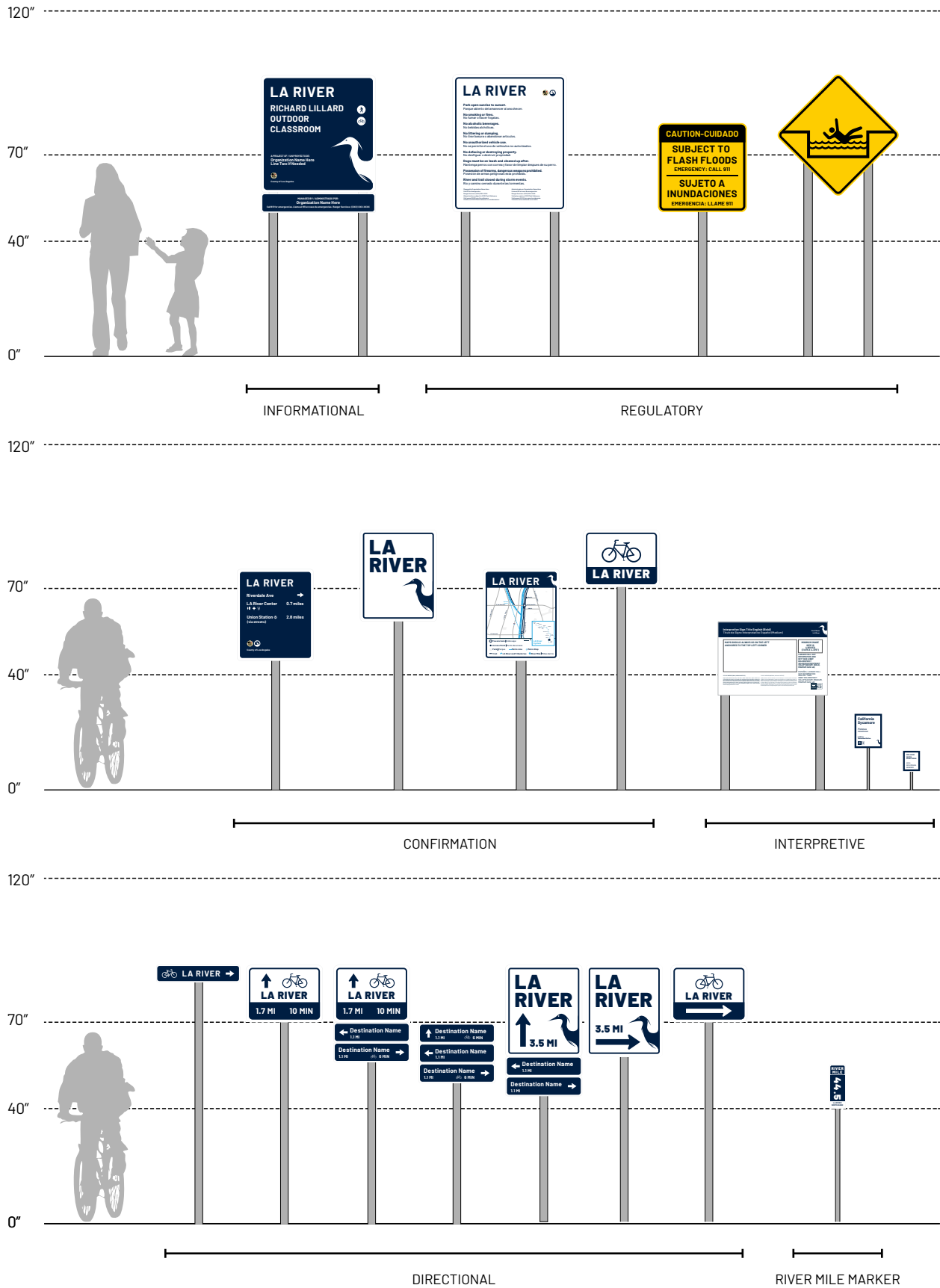


Figure 72. The suite of LA River environmental graphics includes signs leading to the LA River and signs within projects along the LA River.



# SUITE OF LA RIVER ENVIRONMENTAL GRAPHICS

The suite of LA River Environmental Graphics varies depending on the scale of the project. Projects range from XL, L, M, S, and XS as defined in the LA River Master Plan Update and in the Chapter 2 Project Programming section in the Design Guidelines. The quantity of environmental graphics to be used leading up to and within the project grows with the intended size and impact. The diagram on the following page is important for consistency of environmental graphics for the LA River, since it will primarily be installed on a project by project basis. Further, the permitting matrix in this chapter outlines when certain categories of environmental graphics need to have certain criteria, such as font sized to ADA standards or references to Indigenous Peoples place names.

There are eight categories of environmental graphics included in these guidelines.

- Informational (see page 118)
- Regulatory (see page 121)
- Confirmation (see page 126)
- Interpretive signs and displays (see page 131)
- Directional (see page 136)
- River Mile Markers (see page 145)
- River Mile Pavement Markings (see page 147)
- Large Scale Icon Graphics (see page 151)

# SUITE OF LA RIVER ENVIRONMENTAL GRAPHICS



Figure 73. Baseline requirements for environmental graphics leading to the LA River and projects within the LA County Flood Control District right-of-way depend on the scale of the project. Directional signage is required to be two miles away from an XL project, while only required to be 500 feet away from an S project. Directional signage for bicycles are required only for XL-M projects. At gateways, Information signage and Regulatory environmental graphics are required for S-XL projects. Within an XS project, Interpretive, River Mile Pavement Markings, and River Mile Markers are required. Confirmation signs are required with S-XL projects. Incorporation of Large Scale Graphics with L and XL projects should be considered.

GATEWAY

WITHIN PROJECT

PROJECT IDENTITY + INFORMATION


## ENVIRONMENTAL GRAPHICS PERMITTING MATRIX

	INFORMATIONAL	REGULATORY	CONFIRMATION
<p><b>ADA FONT SIZE</b> Size to be determined by height of text off grade and viewing distance as outlined in the most current ADA standards</p>	YES	Check requirements on a project by project basis	YES Exception is the trail map sign, which has text that is meant to be read up close
<p><b>ADA FONT</b> Sans serif font, capitalized as necessary per most current ADA standards - use open-source Barlow font</p>	YES	YES	YES
<p><b>CONTRAST</b> Recommended contrast ratio is 7:1 - achieved when recommended colors are used</p>	YES	YES	YES
<p><b>BILINGUAL</b> Language dependent on neighborhood Examples: Spanish, Chinese, Korean, Russian</p>	NO Names of locations and managing organizations do not need to be translated	YES	NO
<p><b>UNIVERSAL DESIGN</b> Includes audio components for environmental graphics; also includes considerations for the neurodiverse (contrast, colors, &amp; layout already inherent in many of the sign designs)</p>	STRONGLY ENCOURAGED	STRONGLY ENCOURAGED	STRONGLY ENCOURAGED
<p><b>INDIGENOUS PLACE NAMES &amp; REFERENCES</b> Content dependent on site location along the LA River</p>	STRONGLY ENCOURAGED Contact appropriate Indigenous Peoples representative per site location and River Mile	NO	STRONGLY ENCOURAGED Contact appropriate Indigenous Peoples representative per site location and River Mile

Figure 74. This matrix lists the minimum design feature requirements for each category of environmental graphics. Specific requirements will be determined on a project by project basis. These parameters provide the best practices for clear, uncluttered text layout and consistency.

<b>DIRECTIONAL</b>	<b>RIVER MILE MARKERS</b>	<b>RIVER MILE PAVEMENT MARKINGS</b>	<b>INTERPRETIVE SIGNS &amp; DISPLAYS</b>	<b>LARGE SCALE ICON GRAPHICS</b>
<b>YES</b>	<b>YES</b>	<b>YES</b> Check requirements on a project by project basis for graphics on pavement	Check requirements on a project by project basis	Check requirements on a project by project basis
<b>YES</b>	<b>YES</b>	<b>YES</b> Check requirements on a project by project basis for graphics on pavement	<b>YES</b>	Check requirements on a project by project basis
<b>YES</b>	<b>YES</b>	<b>YES</b>	<b>YES</b>	<b>NO</b> Guidelines color is not required, choices are to artist's discretion
<b>NO</b>	<b>NO</b>	<b>NO</b>	<b>YES</b>	<b>STRONGLY ENCOURAGED</b>
<b>SOMETIMES</b> Encouraged for wayfinding along pedestrian paths of travel	<b>NO</b>	<b>NO</b>	<b>STRONGLY ENCOURAGED</b>	<b>STRONGLY ENCOURAGED</b>
<b>STRONGLY ENCOURAGED</b> Contact appropriate Indigenous Peoples representative per site location and River Mile	<b>NO</b>	<b>NO</b>	<b>STRONGLY ENCOURAGED</b> Contact appropriate Indigenous Peoples representative per site location and River Mile	<b>STRONGLY ENCOURAGED</b> Contact appropriate Indigenous Peoples representative per site location and River Mile



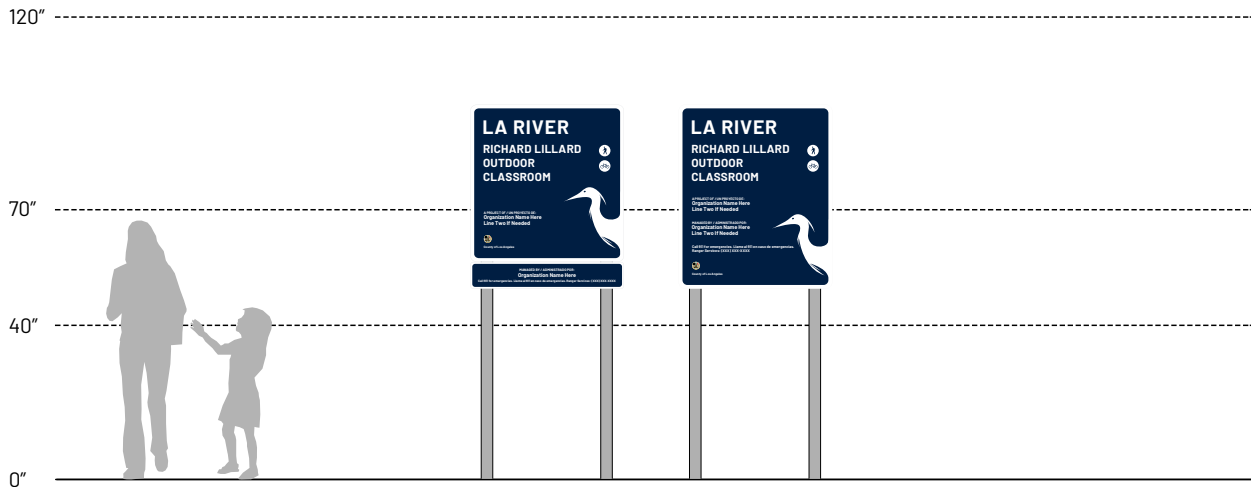


Figure 75. Freestanding informational environmental graphics should be on double posts with the bottom of the sign between 40" and 45" minimum above grade.

## INFORMATIONAL

### PURPOSE

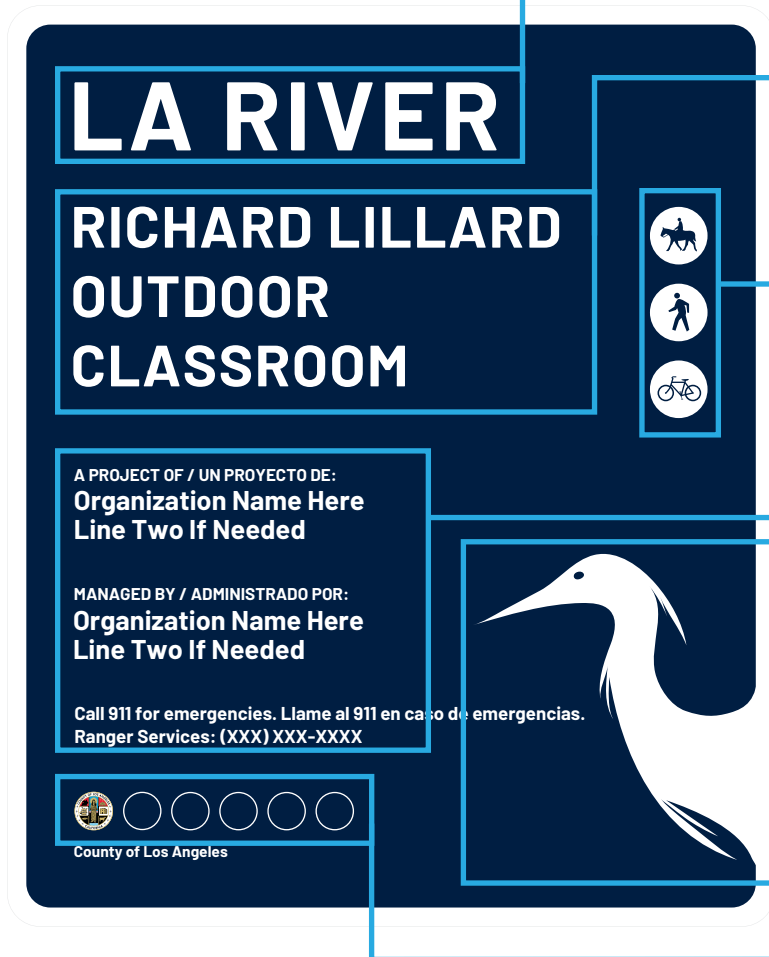
Informational signs are used to inform visitors about a place, and include park entry signs and other non-regulatory signs.

As necessary, these signs are used to inform visitors about the park or trail, the owner or operator, funding source(s), and agencies and organizations involved with the project. Grant funding sources may have specific requirements for credits and graphics.

### PLACEMENT

Locations of Informational signs should be placed near the primary access point and be visible from the street or trail to aid visitors in finding the park or trail. A single Informational sign should be placed at the access point or gateway to reduce visual clutter.

## INFORMATIONAL - OPTION 1 ONE SIGN



### TITLE 1

**Text:** LA RIVER  
**Font:** Barlow - Bold, All Caps  
**Size:** 3.5" high  
**Color:** White  
**Position:** Left aligned, 3" from top of blue background, 2.5" from left

### TITLE 2

**Text:** LOCATION NAME  
**Font:** Barlow - Bold, All Caps  
**Size:** 2" high (minimum)  
**Color:** White  
**Position:** Left aligned, 3" from bottom of Title 1 text, 2.5" from left edge of blue background, 1.5" between lines

### TRAIL USAGE SYMBOLS

**Size:** Symbols centered in 3" circle  
**Color:** Circle-White, Symbol - Pantone 282 C  
**Position:** 2.5" from right edge of blue background; spaced 1" apart vertically; top aligned with top of Title 2 text  
 \* Only include symbols for usage on trail at this access point  
 \*\* See MUTCD for approved symbols

### INFORMATIONAL TEXT

**Font:** Barlow - Bold, Title Case  
**Size:** .625" minimum height of capital letter  
**Color:** White  
**Position:** Left aligned; 2.5" from left edge of blue background, 2.5" vertical space between separate groups of text

### HERON GRAPHIC

**Size:** 16" high  
**Color:** White  
**Position:** Flush right with white border; 2.5" from bottom edge of blue background

### LOGOS

**Size:** 2" circles with 5 pt white stroke  
**Position:** 2.5" from left edge of blue background, 4" from bottom; spaced .5" apart horizontally  
 \* Remove all unused logo circles

Figure 76. Informational signs provide the location name, owner, operator, and funding source of a project, along with trail usage symbols denoting types of trails available.

## SIGN SPECIFICATIONS

- **Size:** 40x48" with 1.75" radius rounded corners
- **White border of sign:** 1" on all sides
- **Material:** Aluminum with anti-graffiti treatment
- **Background:** Pantone 282 C with 1.25" radius rounded corners
- **Margins within background:** 3" from top, 2.5" on left, right, and bottom

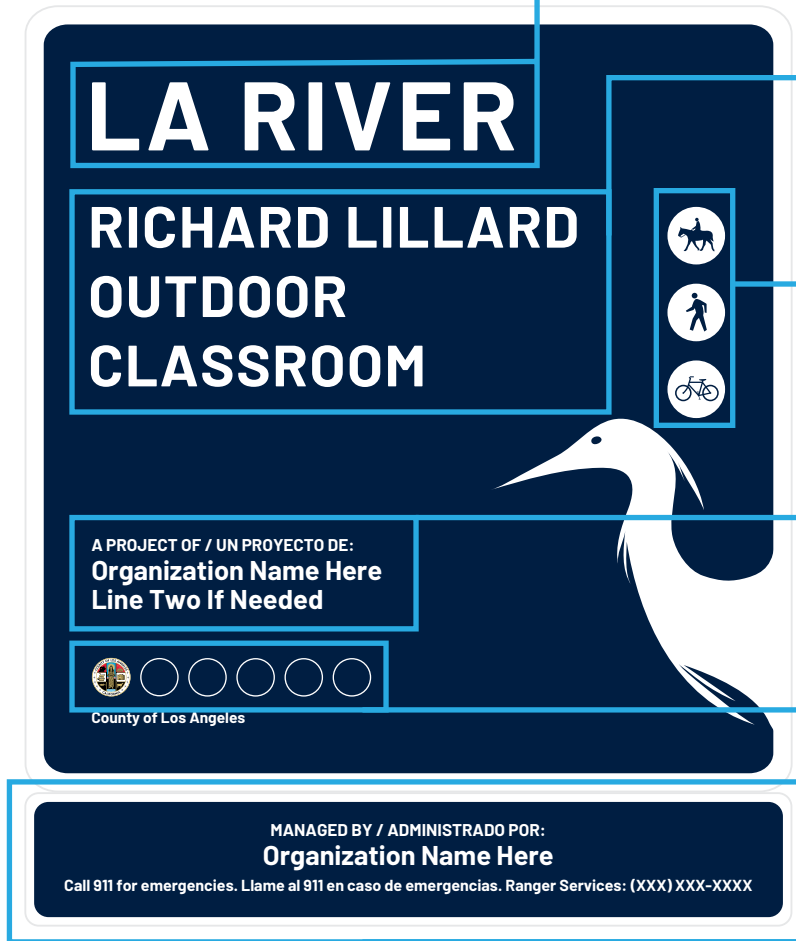
## INSTALLATION

- At access point, not directly on a circulation path
- Bottom of sign located between 40" and 45" off the ground and on double posts if freestanding

## NOTES

- Always confirm specifications with latest applicable guidelines

## INFORMATIONAL - OPTION 2 SIGN WITH BOTTOM PANEL



### TITLE 1

**Text:** LA RIVER  
**Font:** Barlow - Bold, All Caps  
**Size:** 3.5" high  
**Color:** White  
**Position:** Left aligned, 3" from top of blue background, 2.5" from left

### TITLE 2

**Text:** LOCATION NAME  
**Font:** Barlow - Bold, All Caps  
**Size:** 2" high (minimum)  
**Color:** White  
**Position:** Left aligned, 3" from bottom of Title 1 text, 2.5" from left edge of blue background, 1.5" between lines

### TRAIL USAGE SYMBOLS

**Size:** Symbols centered in 3" circle  
**Color:** Circle-White, Symbol - Pantone 282 C  
**Position:** 2.5" from right edge of blue background; spaced 1" apart vertically; top aligned with top of Title 2 text  
 \* Only include symbols for usage on trail at this access point  
 \*\* See MUTCD for approved symbols

### INFORMATIONAL TEXT

**Font:** Barlow - Bold, Title Case  
**Size:** .625" minimum height of capital letter  
**Color:** White  
**Position:** Left aligned; 2.5" from left edge of blue background

### LOGOS

**Size:** 2" circles with 5 pt white stroke  
**Position:** 2.5" from left edge of blue background, 4" from bottom; spaced .5" apart horizontally  
 \* Remove all unused logo circles

### INFORMATIONAL PANEL

**Size:** 40x7" with .75" radius rounded corners  
**White border:** .5" on all sides  
**Material:** Aluminum with anti-graffiti treatment  
**Background:** Pantone 282 C with .75" radius rounded corners  
**Margins within background:** 1.15" on all sides

**Font:** Barlow - Bold, Title Case,  
**Size:** .625" minimum height of capital letter  
**Color:** White  
**Text Position:** Center aligned, 1.15" from all edges of blue background

**Placement:** Located below Informational sign, flush edge to edge ; bottom of sign between 40" and 45" off the ground or a minimum of 80" off the ground and on double posts if freestanding

Figure 77. The information panel allows for ease of updating information such as management and funding.

## SIGN SPECIFICATIONS

- **Size:** 40x41" with 1.75" radius rounded corners
- **White border of sign:** 1" on all sides
- **Material:** Aluminum with anti-graffiti treatment
- **Background:** Pantone 282 C with 1.25" radius rounded corners
- **Margins within background:** 3" from top, 2.5" on left, right, and bottom

## INSTALLATION

- At access point, not directly on a circulation path
- Bottom of information sign combination (sign and below panel) located between 40" and 45" off the ground and on double posts if freestanding

## NOTES

- Separate informational panel allows for flexibility to update only partial and potentially more frequently changing content
- Always confirm specifications with latest applicable guidelines

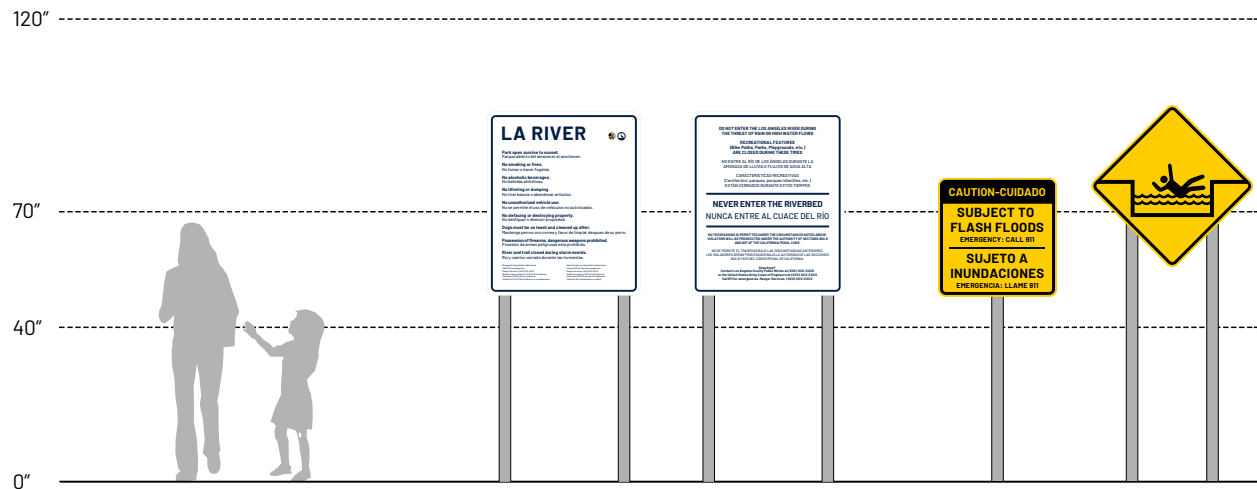


Figure 78. Regulatory environmental graphics should be placed so that the bottom-most text is between 40”-70” above grade. Certain freestanding signs require double posts.

# REGULATORY

## PURPOSE

Regulatory signs are used to alert users to rules and regulations within LA River parks or multiuse trails. They are also used to warn park and trail users of dangerous conditions or to inform bicyclists and drivers of regulations and upcoming conditions. Under the California Code of regulations rules and specific code numbers must be posted in order to be enforced by patrolling park rangers and police officers.<sup>18</sup>

For additional Regulatory signs needed for flood safety or other municipal requirements, refer to the standard guidelines of the appropriate regulatory agency for color, size, content, and materials.

## PLACEMENT

Regulatory signs are typically placed at or near park entrances or access points. Certain regulatory sign placement needs to follow uniform traffic standards and MUTCD guidelines. All users should be able to see the regulatory signs as they enter the park or multiuse trails. Signs warning users of flood danger should be placed along the channel itself. To prevent trespass, signs should be posted informing trail users of adjacent private property and instructing them to respect private lands by staying on the trail. Trail signs that are located on public and private property boundaries should inform trail users when they are entering and leaving private lands.

## REGULATORY RULES

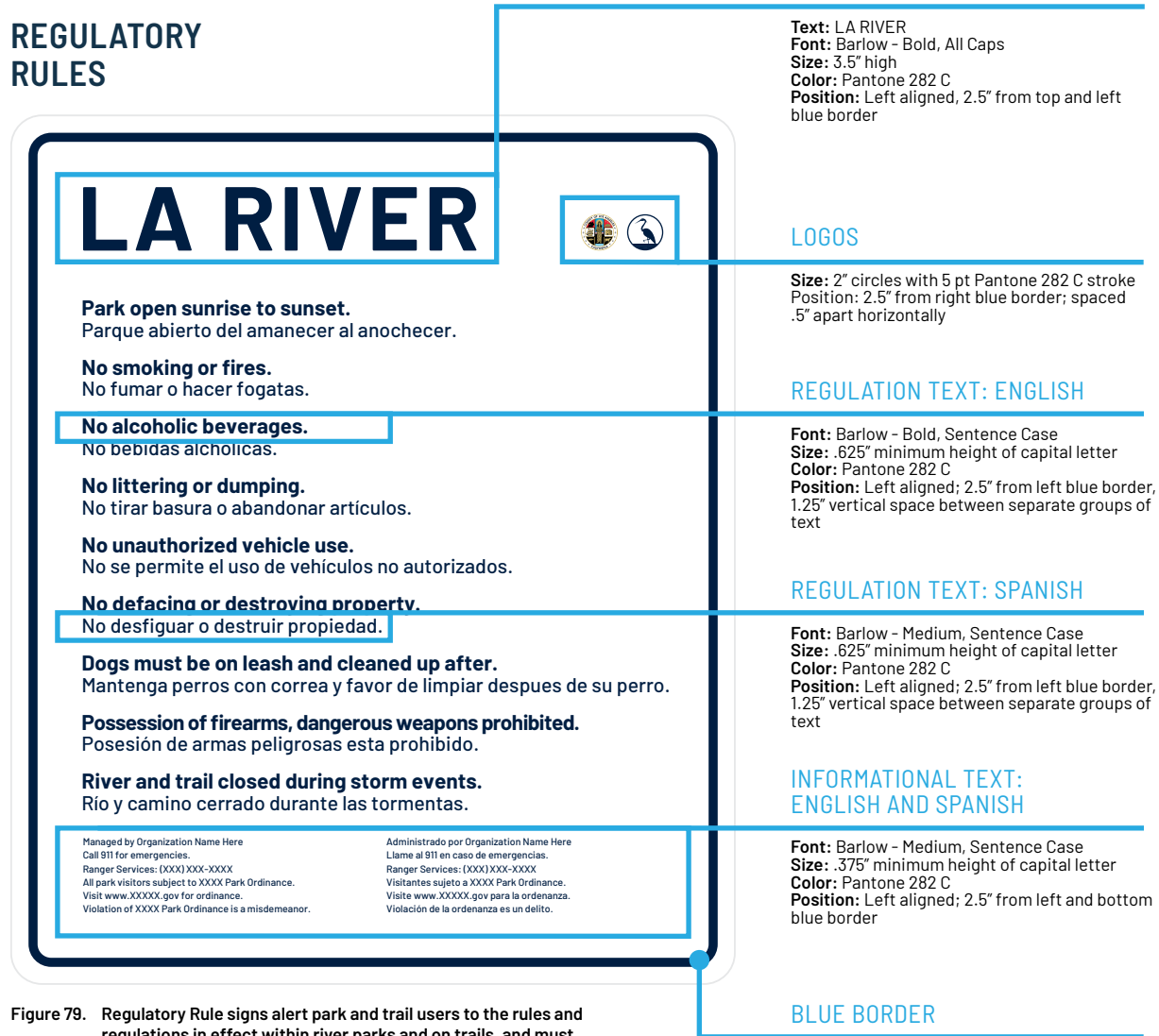


Figure 79. Regulatory Rule signs alert park and trail users to the rules and regulations in effect within river parks and on trails, and must be bilingual.

## SIGN SPECIFICATIONS

- **Size:** 40x48" with 1.75" radius rounded corners
- **White border of sign:** 1" on all sides
- **Material:** Aluminum with anti-graffiti treatment
- **Background:** White with 0.5" blue border with 1.25" radius rounded corners
- **Margins within background:** 2.5" on all sides

## INSTALLATION

- At access point, not directly on a circulation path
- Bottom of sign located between 40" and 45" off the ground and on double posts if freestanding

## NOTES

- Rules and regulations should always be bilingual
- Always confirm specifications with latest applicable guidelines



## REGULATORY WARNING

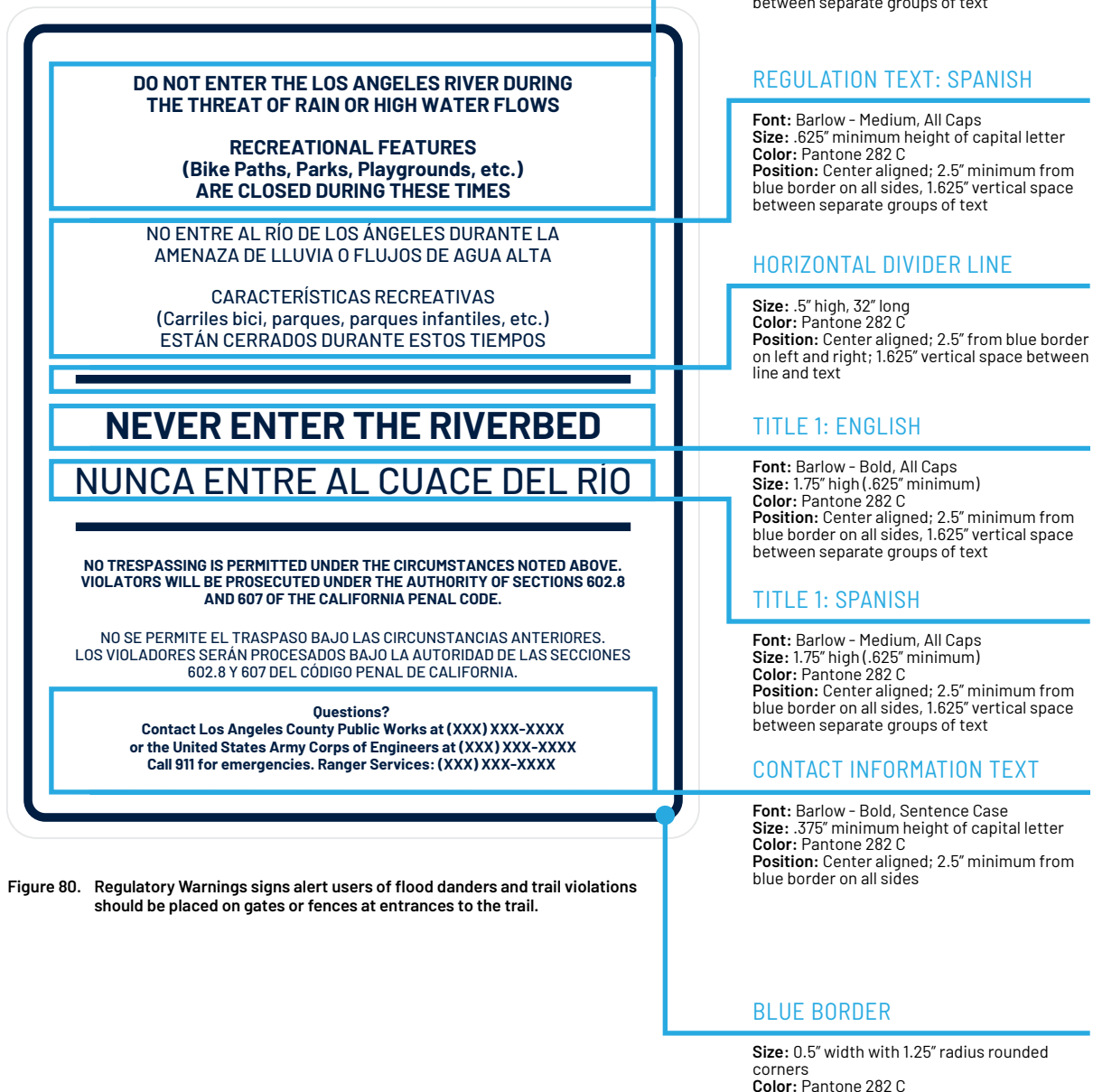


Figure 80. Regulatory Warnings signs alert users of flood dangers and trail violations should be placed on gates or fences at entrances to the trail.

## SIGN SPECIFICATIONS

- **Size:** 40x48" with 1.75" radius rounded corners
- **White border of sign:** 1" on all sides
- **Material:** Aluminum with anti-graffiti treatment
- **Background:** White with 0.5" blue border with 1.25" radius rounded corners
- **Margins within background:** 2.5" on all sides

## INSTALLATION

- At access point, not directly on a circulation path
- Bottom of sign located between 40" and 45" and on double posts if freestanding

## NOTES

- Rules and regulations should always be bilingual
- Always confirm specifications with latest applicable guidelines

## REGULATORY HAZARD



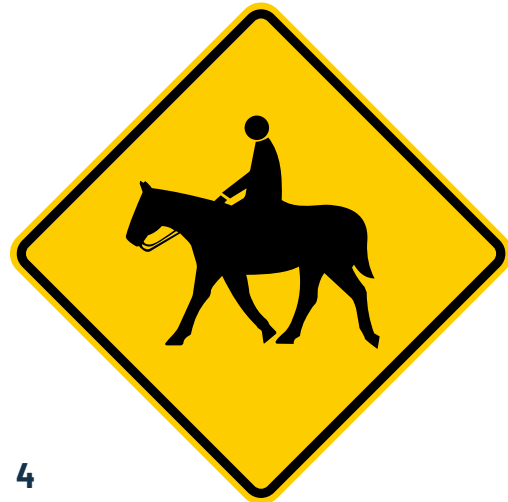
1



2



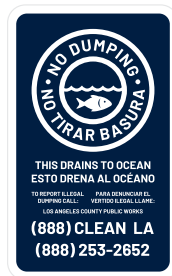
3



4



5



6

Figure 81. The signs shown above (1-4) are examples of warning and safety regulations signs that are standard designs and must not be altered. These guidelines do not provide artwork for these standard signs. Designers should consult latest MUTCD guidelines. Source: 2009 MUTCD Edition with Revisions 1 and 2, 2012.

Figure 82. The signs shown to the left (5-6) are standard regulatory signs, created as part of these guidelines, that must not be altered. Artwork for these standard signs can be downloaded here: [www.larivermasterplan.org/resources](http://www.larivermasterplan.org/resources)

## **STANDARDIZED REGULATORY SIGNS**

Certain Regulatory signs are standard and shall not be altered or customized in order to maintain recognition and consistency. Examples of these standardized signs include MUTCD signs for flood danger, equestrian requirements, parking requirements, and USACE signs for no dumping or littering. These guidelines will not provide the artwork for other agencies standard signage. Refer to appropriate jurisdiction codes for most up-to-date requirements and sign specifications.

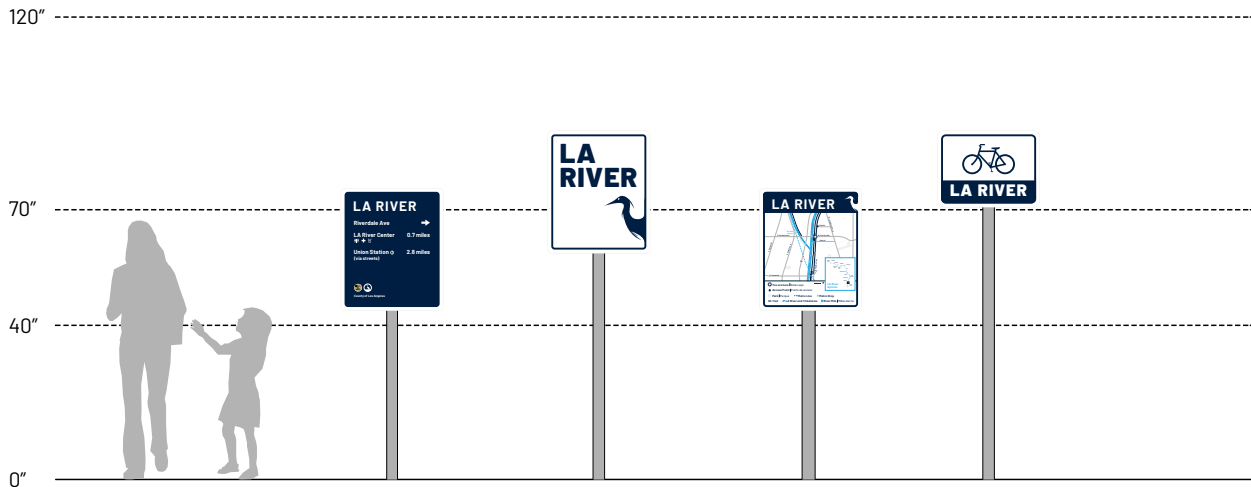


Figure 83. Confirmation environmental graphics should be placed so that the “LA River” text is between 70”–120” above grade.

# CONFIRMATION

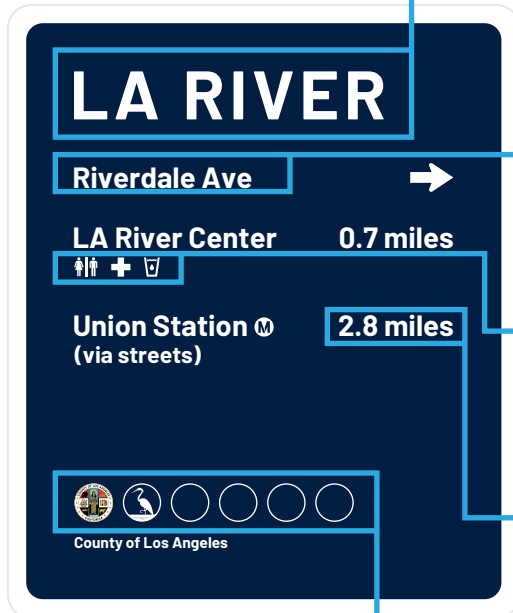
## PURPOSE

Confirmation signs inform users that they are on the correct route or alerts users to an upcoming turn. This information can include distances or time to destination or the LA River. Signs showing destinations should show locations that are ahead on the trail and on the same side of the river bank. They should be double-sided, and can include symbols that indicate locations that have amenities such as restrooms, hydration, and first aid.

## PLACEMENT

Confirmation signs should be placed at access points and along the LA River trail. Confirmation signs showing destinations along the trail should occur at a frequency of no less than two miles. Trail map signs should be placed at access points so that users can identify access points and exits before they embark on their route.

## CONFIRMATION



### TITLE 1

**Text:** LA RIVER  
**Font:** Barlow - Bold, All Caps  
**Size:** 2.5" high  
**Color:** White  
**Position:** Left aligned, 2.5" from top and left edge of blue background

### DESTINATION NAME

**Font:** Barlow - Bold, Title Case  
**Size:** .625" minimum height of capital letter  
**Color:** White  
**Position:** Left aligned; 2.5" from left edge of blue background, 2" vertical space between separate groups of text

### AMENITY SYMBOLS

**Size:** 1" high  
**Color:** White  
**Position:** 2.5" from left edge of blue background; spaced 0.75" apart horizontally; 0.5" below Destination Name  
 \* See MUTCD for approved symbols

### DESTINATION DISTANCE

**Font:** Barlow - Bold, Sentence Case  
**Size:** 0.625" minimum height of capital letter  
**Color:** White  
**Position:** Right aligned; 2.5" from right edge of blue background, aligned with Destination Name vertically

### LOGOS

**Size:** 2" circles with 5 pt white stroke  
**Position:** 2.5" from left edge of blue background, 4" from bottom; spaced .5" apart horizontally  
 \* Remove all unused logo circles

Figure 84. Confirmation signs confirm to the viewer that they are traveling the correct direction and identify the next closest major destinations. They can also indicate arrival at a destination with the addition of an arrow.

## SIGN SPECIFICATIONS

- **Size:** 26.75x32" with 1.25" radius rounded corners
- **White border of sign:** 1" on all sides
- **Material:** Aluminum with anti-graffiti treatment
- **Background:** Pantone 282 C with 0.875" radius rounded corners
- **Margins within background:** 2.5" on all sides

## INSTALLATION

- Along LA River trail
- Bottom of sign located between 40" and 45" off the ground

## NOTES

- Amenity symbols should be MUTCD standard symbols whenever available, custom symbols can only be used when symbol does not exist in from MUTCD
- A left or right arrow replaces the destination distance when the sign is at the destination or at the trail exit for that destination
- Only three destinations per sign
- Always confirm specifications with latest applicable guidelines



## CONFIRMATION AT RIVER

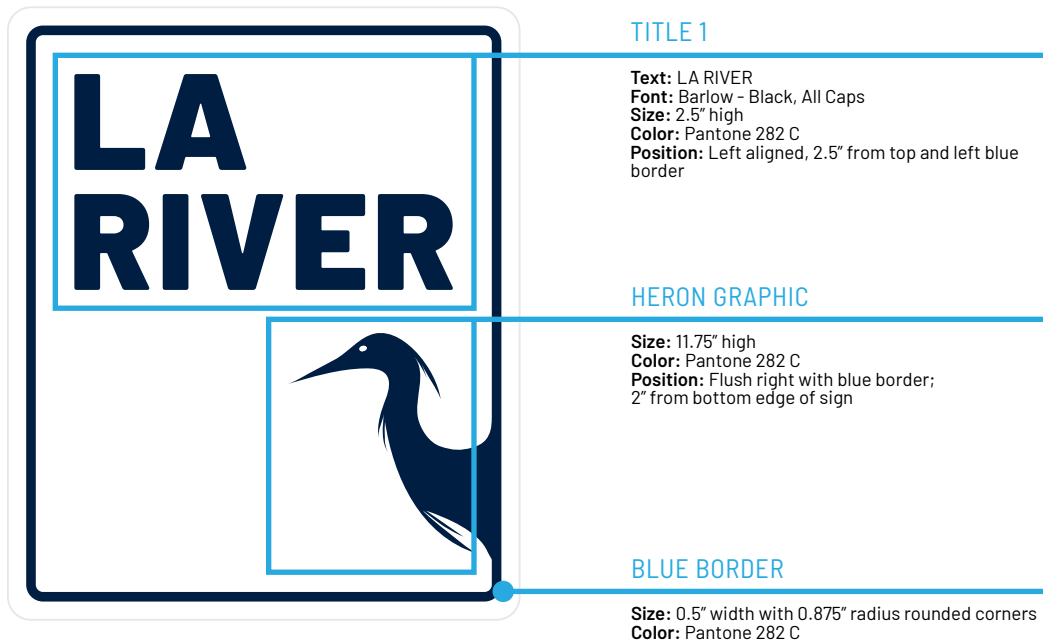


Figure 85. This Confirmation sign should be used at locations such as bridge crossings to confirm the location of the LA River.

### SIGN SPECIFICATIONS

- **Size:** 26.75x32" with 1.25" radius rounded corners
- **White border of sign:** 1" on all sides
- **Material:** Aluminum with anti-graffiti treatment
- **Background:** White with 0.5" blue border with 1.25" radius rounded corners
- **Margins within background:** 2" on all sides

### INSTALLATION

- Key locations close to the LA River, such as on bridge overpasses
- Always confirm specifications with latest applicable guidelines

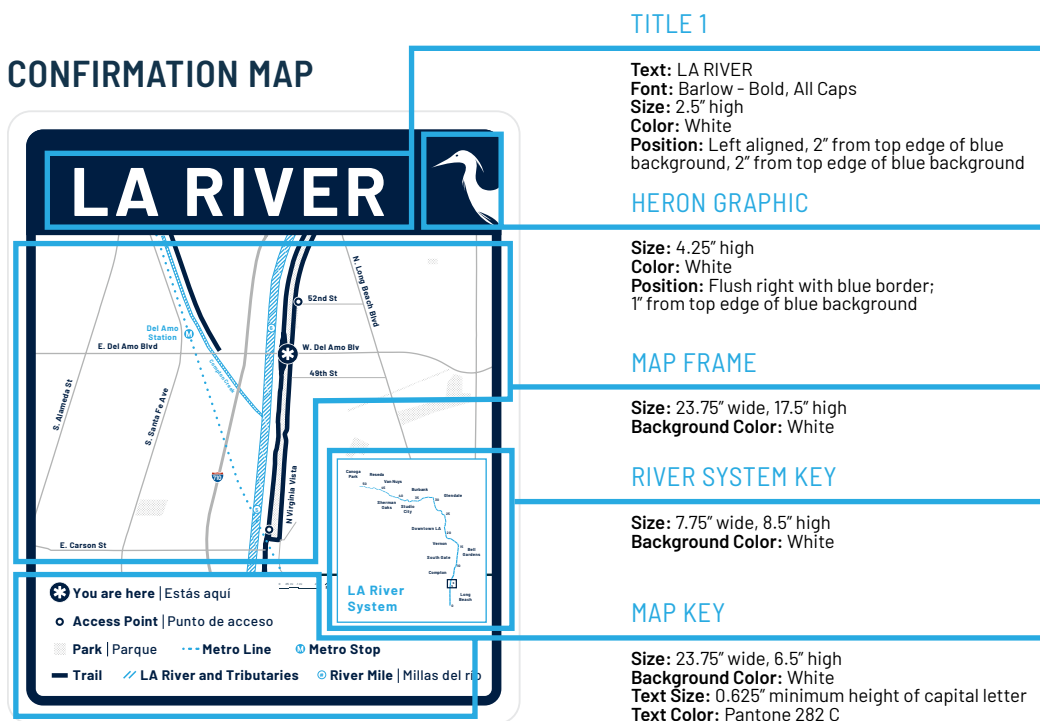


Figure 86. Confirmation maps help users locate where they are on the trail in relation to the river system and the trail itself, and help to locate other access points.

## SIGN SPECIFICATIONS

- Size: 26.75x32" with 1.25" radius rounded corners
- White border of sign: 1" on all sides
- Material: Aluminum with anti-graffiti treatment
- Background: White

## INSTALLATION

- At access point
- Bottom of sign located between 40" and 45" off the ground
- Always confirm specifications with latest applicable guidelines

## CONFIRMATION BIKE ROUTE

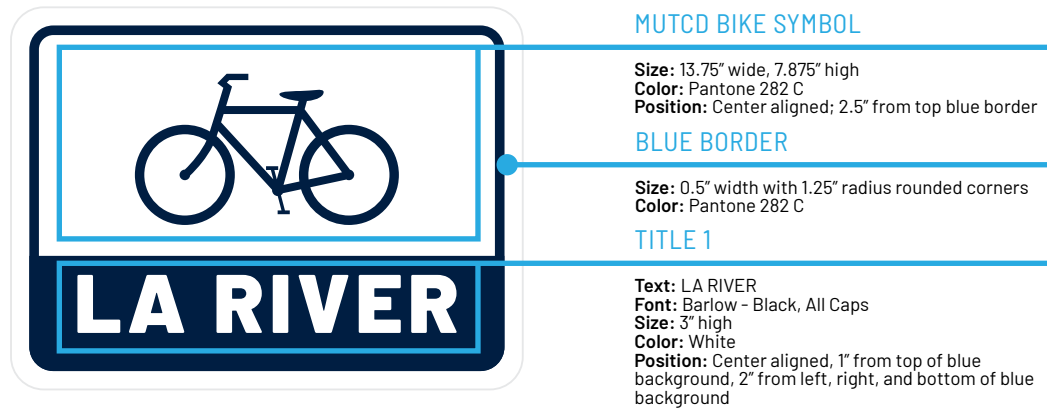


Figure 87. This Confirmation sign should be used for bike routes leading to LA River.

### MUTCD BIKE SYMBOL

**Size:** 13.75" wide, 7.875" high  
**Color:** Pantone 282 C  
**Position:** Center aligned; 2.5" from top blue border

### BLUE BORDER

**Size:** 0.5" width with 1.25" radius rounded corners  
**Color:** Pantone 282 C

### TITLE 1

**Text:** LA RIVER  
**Font:** Barlow - Black, All Caps  
**Size:** 3" high  
**Color:** White  
**Position:** Center aligned, 1" from top of blue background, 2" from left, right, and bottom of blue background

## SIGN SPECIFICATIONS

- **Size:** 26.75x20" with 1.75" radius rounded corners
- **White border of sign:** 1" on all sides
- **Material:** Aluminum with anti-graffiti treatment
- **Background:** White with 0.5" blue border with 1.25" radius rounded corners
- **Margins within background:** 2.5" from top, 2" on left, right, and bottom

## INSTALLATION

- Along bike route, maximum two miles from LA River
- Bottom of sign located between 70" and 120" off the ground

## NOTES

- All bicycle route environmental graphics should be retroreflective per MUTCD requirements.
- Always confirm specifications with latest applicable guidelines

## CONFIRMATION OVERPASS



Figure 88. A Street Identifying signs should be located above the LA River trail denoting name of street above, crossing over the trail.

## SIGN SPECIFICATIONS

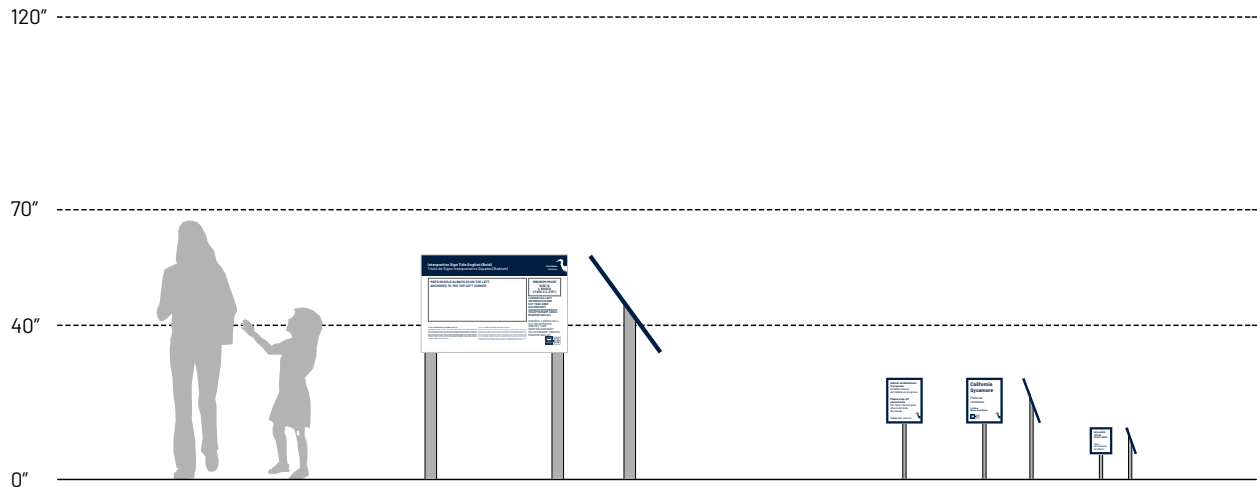
- **Size:** Width varies x 8" with 1" radius rounded corners
- **White border of sign:** 0.25" on all sides
- **Material:** Aluminum with anti-graffiti treatment
- **Background:** White with 0.375" blue border with 1" radius rounded corners
- **Margins within background:** 1.375" top and bottom, 2.375" minimum left and right sides

## INSTALLATION

- On bridge or overpass above trail

## NOTES

- Width of sign will vary base on the length of the name, but margins will remain standard, based on MUTCD guidelines
- Always confirm specifications with latest applicable guidelines



**Figure 89.** Interpretive environmental graphics should be placed at a height that is easily legible. When freestanding, larger signs should be on double posts. Installing and fabricating these types of signs on an angle is recommended. Angle to be determined based on height and use.

# INTERPRETIVE

## PURPOSE

Interpretive signs and displays are used to educate users. Typically, they will be found in LA River parks or at access points to the river and trails. Each park-owning agency will determine the content and use of Interpretive signs.

Suggested topics include geomorphology and engineering of the river, ecological restoration, water supply, water quality, wildlife of the region, natural history of Los Angeles, Indigenous Peoples place markers and traditions, settlement history of Los Angeles, and cultural history of local neighborhoods. Topic selection should consider the content of other Interpretive signs and displays within the river system and the unique features of the project site.

The specifications shown on the following page for Interpretive signs were designed to provide flexibility for the individual sign designers. Consistent to all interpretive signs are the title location, size, color, and font, and the size and location of the heron logo. For ease of sign layout, a grid system will unify sign layout.

## PLACEMENT

Interpretive signs and displays should be placed along trail lookouts, gateways, access points, pocket parks, and within major projects themselves. The location of these environmental graphics is dependent on the educational content and where that is best viewed in context. Their placement should be coordinated with appropriate seating, shade, and other amenities where possible.

# INTERPRETIVE

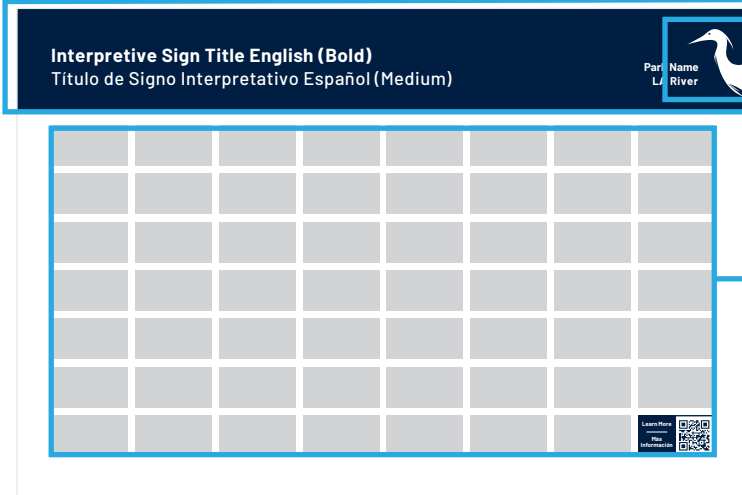


Figure 90. The content grid of the Interpretive sign provides a template for the layout of content.

## TITLE BAND

Size: 5" high, 36" wide  
Color: Pantone 282 C

## HERON GRAPHIC

Size: 3.5" high  
Color: White  
Position: Flush right with edge of sign

## CONTENT GRID

Size: 32.625x16.25"; each grid box size is 3.75x2"  
Position: Center aligned; 1.6875" from left and right edge of sign, 0.75" from top title band, 2" from bottom edge of sign, 0.375" vertical and horizontal space between separate groups of text

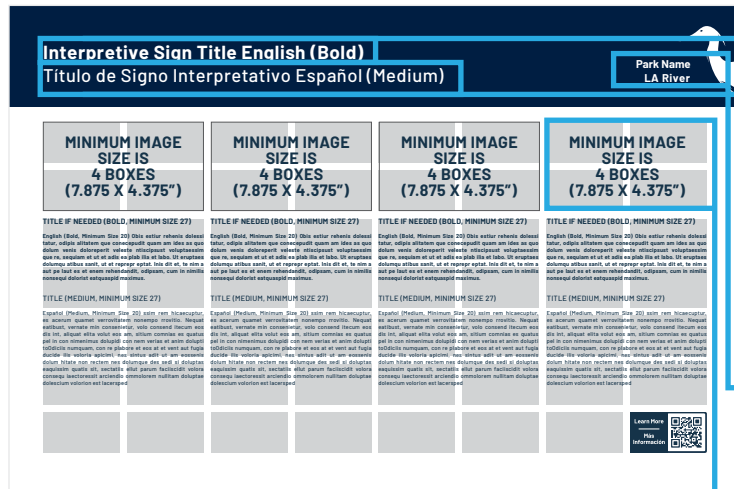


Figure 91. There are many different ways that the grid can be used for the layout of Interpretive signs. The above example shows one method of basic organization with a hierarchy of text sizes.

## SIGN TITLE: ENGLISH

Font: Barlow - Bold, Title Case  
Size: 0.625" minimum height of capital letter  
Color: White  
Position: Left aligned; 2" from top edge of sign, 1.6875" from left edge of sign

## SIGN TITLE: SPANISH

Font: Barlow - Medium, Title Case  
Size: 0.625" minimum height of capital letter  
Color: White  
Position: Left aligned; 1.25" from bottom edge of title band, 1.6875" from left edge of sign

## LOCATION

Font: Barlow - Bold, Title Case  
Size: 40 pt  
Color: White  
Position: Right aligned; 2.5" from right edge of sign

## IMAGES

Minimum Size: 7.875" wide by 4.375" high;  
4 grid boxes

## USING THE GRID

Text, photographs, maps, and illustrations should be aligned on the grid at the discretion of the designer. Each grid box is 3.75 inches wide by 2 inches tall, and are evenly spaced  $\frac{3}{8}$  inch apart, allowing for adequate space between different types of content. Images should not be any smaller than 4 grid boxes,  $7\frac{1}{8}$  inches wide by  $4\frac{3}{8}$  tall. When using a large map or graphic they should be anchored in the top left corner of the grid and additional content should align below or to the right of the large map or graphic. Creating hierarchy between different types of content will help the viewer to digest the content more easily.

Larger sized text callouts can be used to draw attention to important points and can help to break up large amounts of text. Bold titles within text can also be used to better segment text on an Interpretive sign. Interpretive signs should be bilingual to better speak to more users. It is recommended to differentiate languages with different type weights for a quicker and easier navigation of content on the sign.



# INTERPRETIVE

## MAPS AND LARGE IMAGES/DIAGRAMS

**Interpretive Sign Title English (Bold)**  
Título de Signo Interpretativo Español (Medium)

**MAPS SHOULD ALWAYS GO ON THE LEFT ANCHORED TO THE TOP LEFT CORNER**

**MINIMUM IMAGE SIZE IS 4 BOXES (7.875 X 4.375")**

**LARGER CALL OUT INFORMATION AND KEY TAKE AWAY DOLOREPERIT VELESTE NTISCIPSUST VOLUPTAESSIM (BOLD, MINIMUM SIZE 48)**

**ESPAÑOL LARGER CALL OUT INFORMATION AND KEY TAKE AWAY DOLOREPERIT VELESTE NTISCIPSUST VOLUPTAESSIM (MEDIUM, MINIMUM SIZE 48)**

**Position:** Top left corner, 1.6875" from left edge of sign, 0.75" from top blue Title Band

**CALL OUT TEXT: ENGLISH**

**Font:** Barlow - Bold, All Caps  
**Size:** 48 pt minimum  
**Color:** Pantone 282 C  
**Position:** Left aligned; 1.6875" minimum from right edge of sign

**CALL OUT TEXT: SPANISH**

**Font:** Barlow - Medium, All Caps  
**Size:** 48 pt minimum  
**Color:** Pantone 282 C  
**Position:** Left aligned; 1.6875" minimum from right edge of sign

Figure 91. Images or maps should also be incorporated into Interpretive signs as focal points.

**Interpretive Sign Title English (Bold)**  
Título de Signo Interpretativo Español (Medium)

**LARGER CALL OUT INFORMATION AND KEY TAKE AWAY DOLOREPERIT VELESTE NTISCIPSUST VOLUPTAESSIM (BOLD, MINIMUM SIZE 48)**

**ESPAÑOL LARGER CALL OUT INFORMATION AND KEY TAKE AWAY DOLOREPERIT VELESTE NTISCIPSUST VOLUPTAESSIM (MEDIUM, MINIMUM SIZE 48)**

**MINIMUM IMAGE SIZE IS 4 BOXES (7.875 X 4.375")**

**MINIMUM IMAGE SIZE IS 4 BOXES (7.875 X 4.375")**

**MINIMUM IMAGE SIZE IS 4 BOXES (7.875 X 4.375")**

**INFORMATIONAL TEXT: ENGLISH**

**Font:** Barlow - Bold, Sentence case  
**Size:** 20 pt minimum  
**Color:** Pantone 282 C  
**Position:** Left justified, text box aligned with grid

**INFORMATIONAL TEXT: SPANISH**

**Font:** Barlow - Medium, Sentence case  
**Size:** 20 pt minimum  
**Color:** Pantone 282 C  
**Position:** Left justified, text box aligned with grid

**QR CODE FOR MORE INFORMATION**

**Font:** Barlow - Bold, Title Case  
**QR Code Size:** 1x1" minimum  
**Color:** Pantone 282 C  
**Position:** Aligned with grid  
**Note:** Optional addition. Text and code will vary.

Figure 92. Large callouts or quotes can be incorporated into Interpretive signs to highlight key information. QR codes can also be added as an additional resource to learn more.

## SIGN SPECIFICATIONS

## INSTALLATION

- **Size:** 36x24"
- **Material:** Varies per project with anti-graffiti treatment
- **Background:** White
- **Header:** 5" tall Pantone 282 C band spanning width of sign
- **Margins from edge of sign:** 2" on top and bottom, and 1.6875" on left and right

- Along trail, not directly on circulation path
- Bottom of sign located at a height where text is legible, on double posts if freestanding

## NOTES

- Should always be bilingual
- Always confirm specifications with latest applicable guidelines

## INTERPRETIVE-SMALL

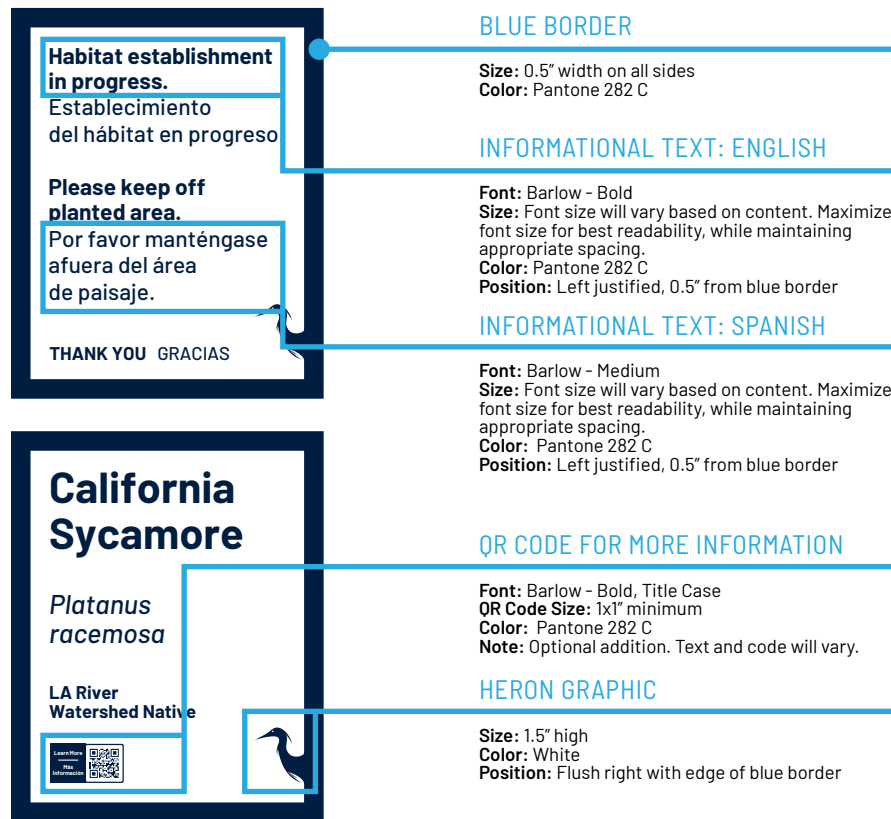


Figure 93. Sample content for smaller Interpretive signs, typically located low to the ground in a planted area. Content for these signs will vary.

## SIGN SPECIFICATIONS

- **Size:** 8x10"
- **Material:** Varies per project with anti-graffiti treatment
- **Background:** White
- **Border:** 0.5" wide Pantone 282 C border on all edges of sign
- **Margins from edge of sign:** 1" on all sides

## INSTALLATION

- Along trail and in planted areas, not directly on circulation path
- Bottom of sign located at a height between 7" and 22" off the ground
- Face of sign angled up. Angle to be determined based on height and use

### •NOTES

- Should always be bilingual
- Always confirm specifications with latest applicable guidelines

## INTERPRETIVE-SMALL

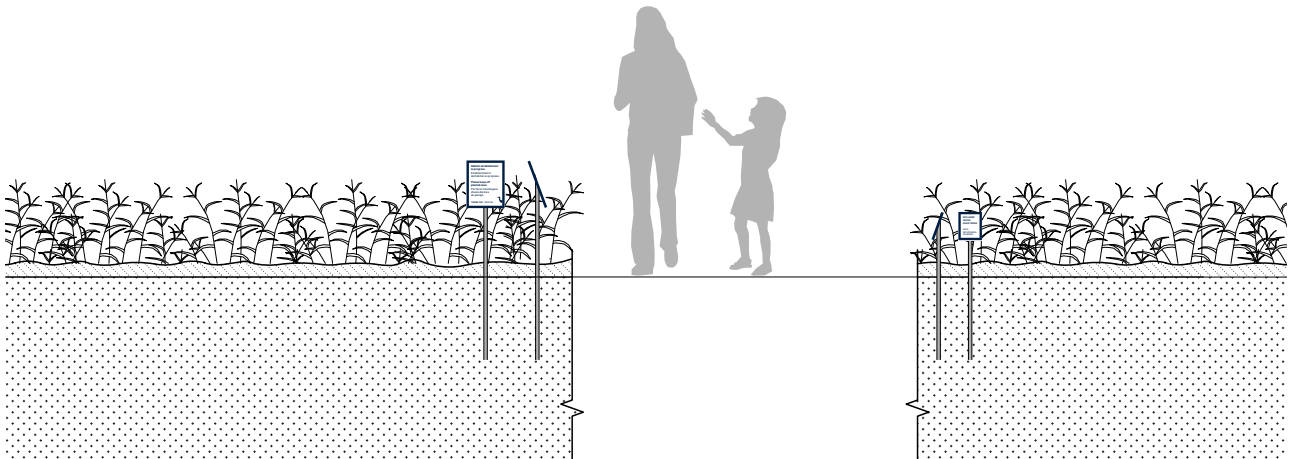
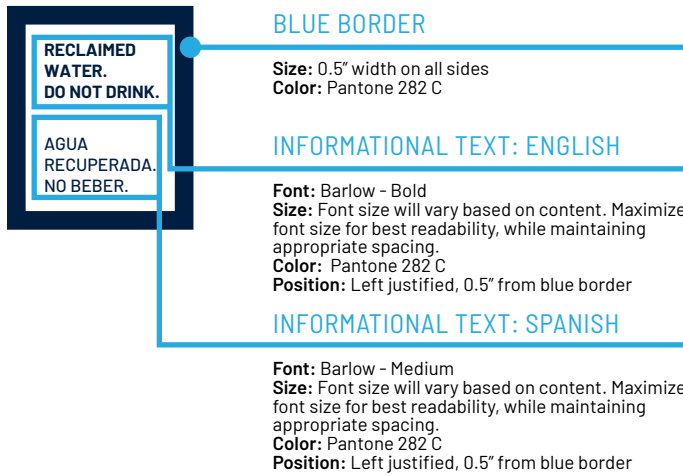


Figure 94. Interpretive signs should be installed and fabricated so that face of sign is angled up. Angle to be determined based on height and use.

### SIGN SPECIFICATIONS

- **Size:** 5x6"
- **Material:** Varies per project with anti-graffiti treatment
- **Background:** White
- **Border:** 0.5" wide Pantone 282 C border on all edges of sign
- **Margins from edge of sign:** 1" on all sides

### INSTALLATION

- Along trail and in planted areas, not directly on circulation path
- Bottom of sign located at a height between 7" and 22" off the ground
- Face of sign angled up. Angle to be determined based on height and use

### NOTES

- Should always be bilingual
- Always confirm specifications with latest applicable guidelines

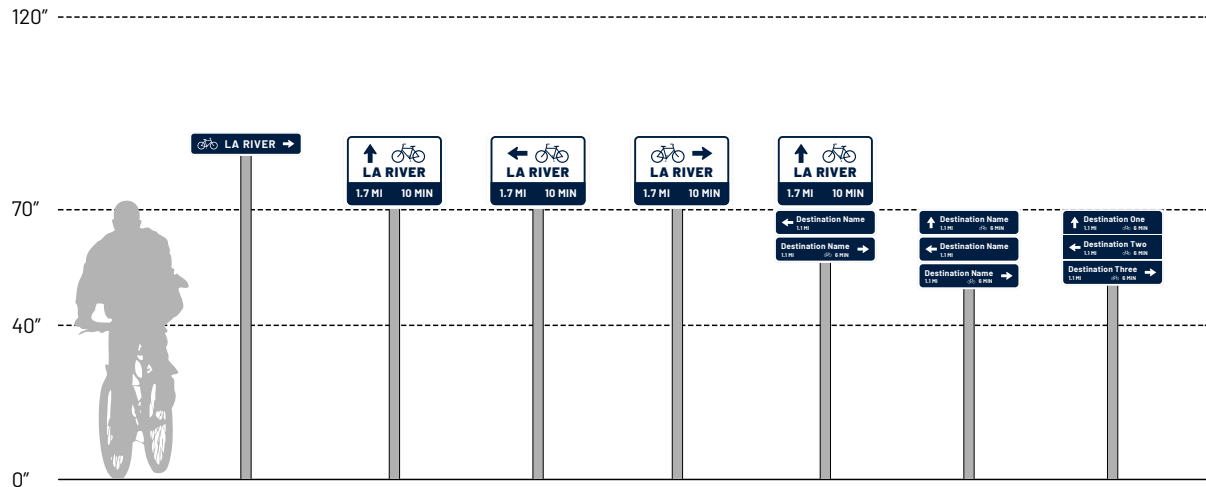


Figure 95. Directional environmental graphics should be placed along bike routes leading to the LA River and its access points and projects. Estimated times are based on an average six minute mile.

# DIRECTIONAL

## PURPOSE

Directional signs are used to alert travelers to the location of the river, multiuse trails, and river parks. They serve an important wayfinding function and will set traffic patterns to and from the river. Jurisdictionally, these signs will typically be located in Caltrans right-of-way, local municipalities' departments of transportation rights-of-way, or unincorporated LA County. All signs must conform to the appropriate jurisdictional regulations.

## PLACEMENT

Directional environmental graphics should be placed along streets and at intersections that cater to pedestrians and cyclists. Locations chosen should direct users to the river's nearest access point.

To direct users to the LA River from local streets where a Class II or III bike path exists, use the Directional environmental graphics for cyclists. To direct users to the LA River where there is no existing bike path, use signs that address both cyclists and pedestrians. For direction within 500 feet of an access point, use signs with the directional arrow only.

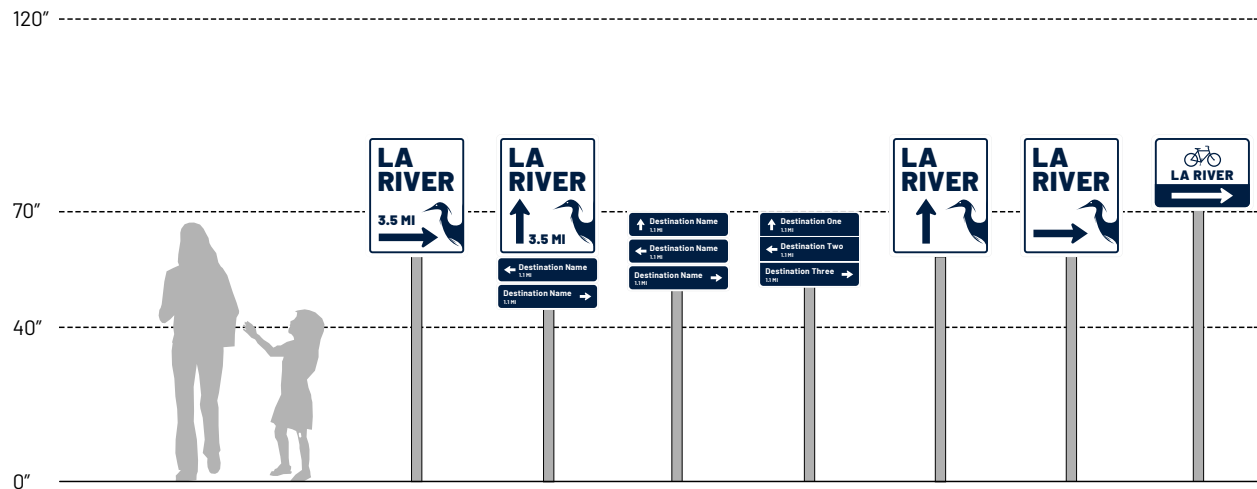


Figure 96. Important guidelines as prescribed by the Manual on Uniform Traffic Control Devices for Streets and Highways. Source: 2009 MUTCD Edition with Revisions 1 and 2, 2012.

## MUTCD GUIDELINES OVERVIEW\*

- All signs should be located at a minimum of 48" above grade.
  - An arrow pointing to the right, if used, shall be at the extreme right-hand side of the sign.
  - An arrow pointing left or up, if used, shall be at the extreme left-hand side of the sign.
  - On bicycle destination signs, a bicycle symbol shall be placed next to each destination or group of destinations. If an arrow is at the extreme left, the bicycle symbol shall be placed to the right of the respective arrow.
  - The bicycle symbol should be to the left of the destination legend.
  - Although the standard design of symbol signs cannot be modified, the orientation of the symbol may be changed to better reflect the direction of travel, if appropriate.
- \*Always use most recent MUTCD Guidelines. Guidelines at time of this publications were 2009 Edition, including Revisions 1 and 2 dated May 2012.

Figure 97. Directional environmental graphics, communicating to both pedestrians and bicyclists, lead to the LA River and its access points and projects from a maximum of two miles away.



## DIRECTIONAL BIKE ROUTE



### MUTCD BIKE SYMBOL

**Size:** 8.75" wide, 5" high  
**Color:** Pantone 282 C  
**Position:** 1.5" from top blue border, 3.875" from right blue border

### TITLE 1

**Text:** LA RIVER  
**Font:** Barlow - Black, All Caps  
**Size:** 2.5" high  
**Color:** Pantone 282 C  
**Position:** Center aligned, 1.25" margin above and below, 3.875" left and right blue border

### DISTANCE

**Font:** Barlow - Bold, All Caps  
**Size:** 2" high  
**Color:** White  
**Position:** Left aligned, 2" from top and bottom of blue background, 2.5" from left of blue background



### DIRECTIONAL ARROW

**Size:** 3.375" width of arrow head, length varies depending on direction pointing  
**Color:** Pantone 282 C  
**Position:** 2.25" from top blue border, 3.875" from right blue border

### BLUE BORDER

**Size:** 0.5" width with 1.25" radius rounded corners  
**Color:** Pantone 282 C

### ESTIMATED TIME

**Font:** Barlow - Bold, All Caps  
**Size:** 2" high  
**Color:** White  
**Position:** Right aligned, 2" from top and bottom of blue background, 2.5" from right of blue background

Figure 98. Place directional bike route signs along bike routes leading to LA River. These signs include a directional arrow, the distance to LA River, and the estimated time to bike there.

## SIGN SPECIFICATIONS

- **Size:** 26.75x20" with 1.75" radius rounded corners
- **White border of sign:** 1" on all sides
- **Material:** Aluminum with anti-graffiti treatment
- **Background:** White with 0.5" blue border with 1.25" radius rounded corners
- **Margins within background:** 1.5" from top, 2" minimum on left and right, and 2" from bottom

## INSTALLATION

- Along bike route, maximum two miles from LA River
- Bottom of sign located between 70" and 120" off the ground

## NOTES

- Arrow pointing right should appear on far right of sign, arrows point straight (up) and left should appear on the far left of sign, arrows pointing down should not be used
- Direction of MUTCD bike symbol travel should change to mimic direction of arrow
- Estimated bike travel time is based on an average six minutes per mile
- All bicycle route directional environmental graphics should be retroreflective per MUTCD requirements
- Always confirm specifications with latest applicable guidelines

## DIRECTIONAL BIKE ROUTE



Figure 99. This LA River Bike Route sign can be mounted above another MUTCD Bike Route sign within 2 miles of LA River access points.

### SIGN SPECIFICATIONS

- **Size:** 29.25x6" with 0.75" radius rounded corners
- **White border of sign:** 0.375" on all sides
- **Material:** Aluminum with anti-graffiti treatment
- **Background:** Pantone 282 C with 0.75" radius rounded corners
- **Margins within background:** 1.625" on top and bottom, and 1.625" minimum on left and right

### INSTALLATION

- Mounted above MUTCD Bike Route signs or stand alone within two miles of river access point



Figure 100. This LA River bike route sign can be mounted above another MUTCD Bike Route sign within 2 miles of LA River access points.

### SIGN SPECIFICATIONS

- **Size:** 24x6" with 0.75" radius rounded corners
- **White border of sign:** 0.375" on all sides
- **Material:** Aluminum with anti-graffiti treatment
- **Background:** Pantone 282 C with 0.75" radius rounded corners
- **Margins within background:** 1.625" on top and bottom, and 1.625" minimum on left and right

### MUTCD BIKE SYMBOL

**Size:** 5.25" wide, 3" high  
**Color:** White  
**Position:** 1.125" from top and bottom of blue background, 2" margin on left and right

### TITLE 1

**Text:** LA RIVER  
**Font:** Barlow - Bold, All Caps  
**Size:** 2" high  
**Color:** White  
**Position:** 1.625" minimum to edge of blue background on all sides

### DIRECTIONAL ARROW

**Size:** 2" width of arrow head, 3" long  
**Color:** White  
**Position:** 1.625" minimum to edge of blue background on all sides

### NOTES

- Arrow pointing right should appear on far right of sign, arrows point straight (up) and left should appear on the far left of sign, arrows pointing down should not be used
- Direction of MUTCD bike symbol travel should change to mimic direction of arrow
- The bicycle symbol should be to the left of the destination name
- All bicycle route directional environmental graphics should be retroreflective per MUTCD requirements
- Always confirm specifications with latest applicable guidelines

### TITLE 1

**Text:** LA RIVER  
**Font:** Barlow - Bold, All Caps  
**Size:** 2" high  
**Color:** White  
**Position:** 1.625" minimum to edge of blue background on all sides

### DIRECTIONAL ARROW

**Size:** 2" width of arrow head, 3" long  
**Color:** White  
**Position:** 1.625" minimum to edge of blue background on all sides

### INSTALLATION

- Mounted above MUTCD Bike Route signs within two miles of river access point

### NOTES

- Arrow pointing right should appear on far right of sign, arrows point straight (up) and left should appear on the far left of sign, arrows pointing down should not be used
- Width of sign should match the width of the MUTCD Bike Route sign it is mounted above. Always confirm specifications with latest applicable guidelines

## DIRECTIONAL BIKE DESTINATION PANELS



Figure 101. LA River Directional Bike Destination sign panels direct users to major destinations and provide the distance and estimated time to bike there. Separate panels allow for multiple destinations to be added over time.

### SIGN SPECIFICATIONS

- **Size:** 26.75x7" with 0.875" radius rounded corners
- **White border of sign:** 0.5" on all sides
- **Material:** Aluminum with anti-graffiti treatment
- **Background:** Pantone 282 C with 0.875" radius rounded corners
- **Margins within background:** 1.5" minimum on all sides

### INSTALLATION

- Along bike route, maximum two miles from LA River
- Bottom of sign located between 48" and 70" off the ground

### NOTES

- When grouping destination signs, maximum three destinations can be grouped per MUTCD standards
- The order of signs located below must be arranged with straight (up) arrow on top, followed by destinations to the left, and then destinations to the right
- Arrow pointing right should appear on far right of sign, arrows point straight (up) and left should appear on the far left of sign, arrows pointing down should not be used
- Direction of MUTCD bike symbol travel should change to mimic direction of arrow
- Estimated bike travel time is based on an average six minutes per mile
- All bicycle route directional environmental graphics should be retroreflective per MUTCD requirements
- Always confirm specifications with latest applicable guidelines

## DIRECTIONAL BIKE DESTINATION COMBINATION SIGN

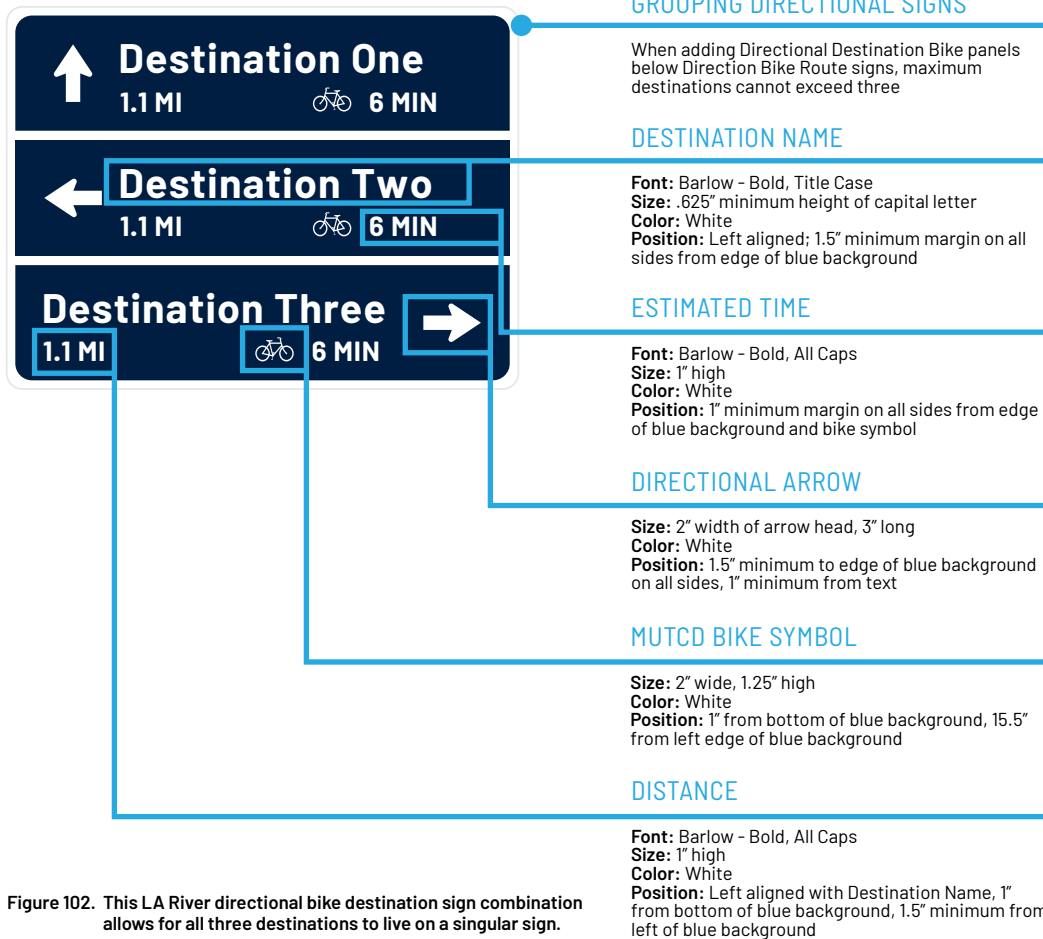


Figure 102. This LA River directional bike destination sign combination allows for all three destinations to live on a singular sign.

## SIGN SPECIFICATIONS

- **Size:** 26.75x20" with 0.875" radius rounded corners
- **White border of sign:** 0.5" on all sides
- **Material:** Aluminum with anti-graffiti treatment
- **Background:** Pantone 282 C with 0.875" radius rounded corners
- **Margins within background:** 1.5" minimum on all sides

## INSTALLATION

- Along bike route, maximum two miles from LA River
- Bottom of sign located between 48" and 70" off the ground

## NOTES

- This single sign is a combination of the maximum three destination allowed per MUTCD standards, as opposed to three separate signs panels

- The order of signs must be arranged with straight (up) arrow on top, followed by destinations to the left, and then destinations to the right
- Arrow pointing right should appear on far right of sign, arrows point straight (up) and left should appear on the far left of sign, arrows pointing down should not be used
- Direction of MUTCD bike symbol travel should change to mimic direction of arrow
- Can include logo to left of destination name (e.g., Metro logo), height of logo or icon should not exceed height of capital letter in destination name
- Estimated bike travel time is based on an average six minutes per mile
- All bicycle route directional environmental graphics should be retroreflective per MUTCD requirements
- Always confirm specifications with latest applicable guidelines

## DIRECTIONAL WITH DISTANCE

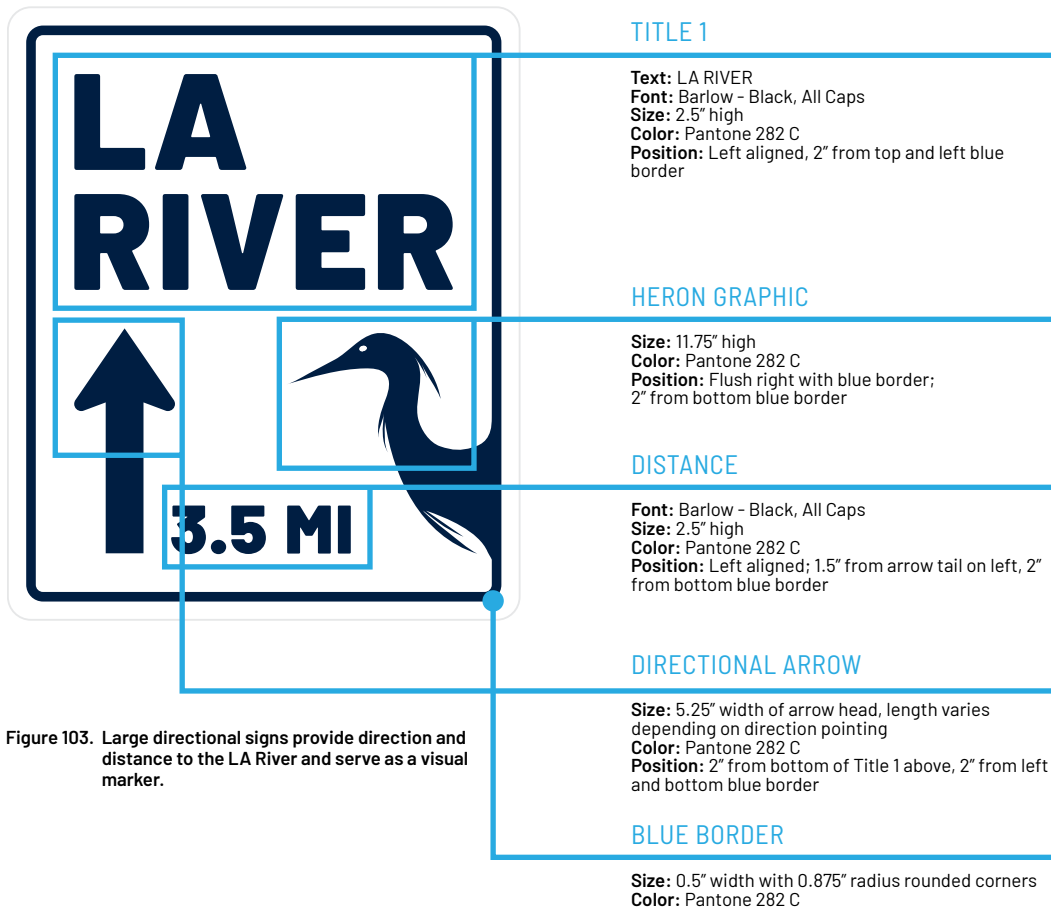


Figure 103. Large directional signs provide direction and distance to the LA River and serve as a visual marker.

### SIGN SPECIFICATIONS

- **Size:** 26.75x32" with 1.25" radius rounded corners
- **White border of sign:** 1" on all sides
- **Material:** Aluminum with anti-graffiti treatment
- **Background:** White with 0.5" blue border with 1.25" radius rounded corners
- **Margins within background:** 2" on all sides

### INSTALLATION

- Key locations leading up to LA River access points from maximum two miles out to minimum 0.5 miles, includes distance
- Bottom of sign located between 48" and 70" off the ground

### NOTES

- When grouping destination signs, maximum three destinations can be grouped per MUTCD standards (i.e., two destination panels can be below this large LA River directional sign)
- The order of signs located below must be arranged with straight (up) arrow on top, followed by destinations to the left, and then destinations to the right
- Always confirm specifications with latest applicable guidelines
- Arrows pointing down should not be used



## DIRECTIONAL PEDESTRIAN DESTINATION PANELS

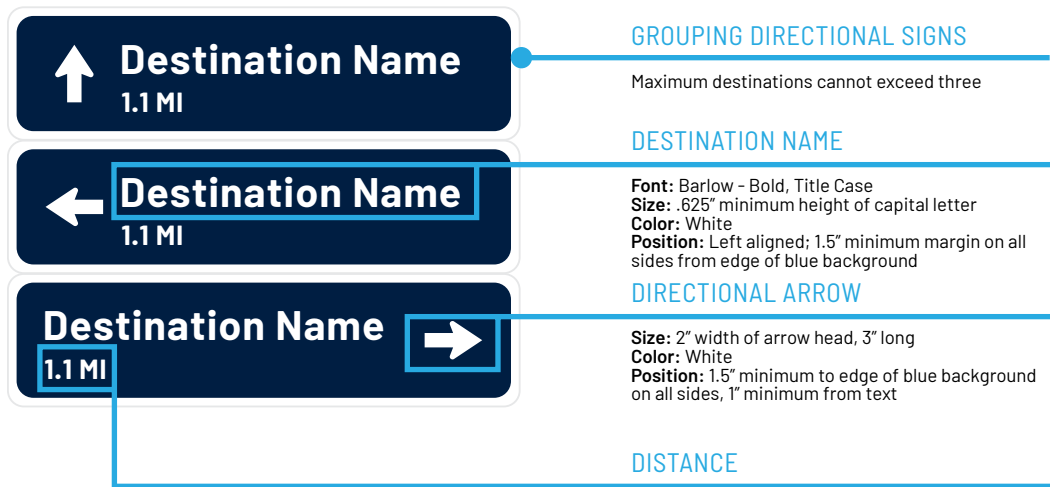


Figure 104. LA River directional destination sign panels direct users to major destinations and the distances to them. At a maximum, three should be stacked together per MUTCD guidelines.

### SIGN SPECIFICATIONS

- **Size:** 26.75x7" with 0.875" radius rounded corners
- **White border of sign:** 0.5" on all sides
- **Material:** Aluminum with anti-graffiti treatment
- **Background:** Pantone 282 C with 0.875" radius rounded corners
- **Margins within background:** 1.5" minimum on all sides

### INSTALLATION

- Key locations leading up to LA River access points from maximum two miles out to minimum 0.5 miles
- Bottom of sign located between 48" and 70" off the ground

### NOTES

- When grouping destination signs, maximum three destinations can be grouped per MUTCD standards
- The order of signs must be arranged with straight (up) arrow on top, followed by destinations to the left, and then destinations to the right
- Arrow pointing right should appear on far right of sign, arrows point straight (up) and left should appear on the far left of sign, arrows pointing down should not be used
- Can include logo to left of destination name (e.g., Metro logo), height of logo or icon should not exceed height of capital letter in destination name
- Always confirm specifications with latest applicable guidelines

## DIRECTIONAL WITHOUT DISTANCE



Figure 105. LA River large directional signs should be used within 0.5 miles from the LA River. Mile numbers do not appear on signs within 0.5 miles of the destination.



Figure 106. LA River bike route directional sign does not show the distance and estimated time when within 0.5 miles of the LA River.

### SIGN SPECIFICATIONS

- **Size:** 26.75x20" with 1.75" radius rounded corners
- **White border of sign:** 1" on all sides
- **Material:** Aluminum with anti-graffiti treatment
- **Background:** White with 0.5" blue border with 1.25" radius rounded corners
- **Margins within background:** 1.5" from top, 3.875" left and right, and 1" from bottom

### SIGN SPECIFICATIONS

- **Size:** 26.75x32" with 1.25" radius rounded corners
- **White border of sign:** 1" on all sides
- **Material:** Aluminum with anti-graffiti treatment
- **Background:** White with 0.5" blue border with 1.25" radius rounded corners
- **Margins within background:** 2" on all sides

### INSTALLATION

- Key locations leading up to LA River access points, maximum 0.5 miles out, does not include distance

### NOTES

- Always confirm specifications with latest applicable guidelines
- Arrows pointing down should not be used

### INSTALLATION

- Along bike route leading up to LA River access points, maximum 0.5 miles out, does not include distance
- Bottom of sign located between 70" and 120" off the ground

### NOTES

- Direction of MUTCD bike symbol travel should change to mimic direction of arrow, arrows pointing down should not be used
- All bicycle route directional environmental graphics should be retroreflective per MUTCD requirements
- Always confirm specifications with latest applicable guidelines

## RIVER MILE MARKERS

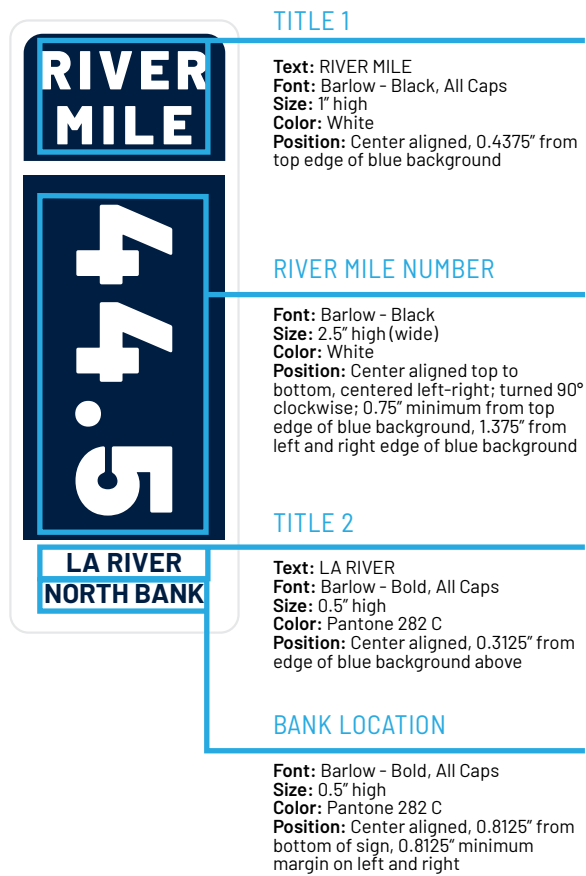


Figure 107. River mile markers must appear every 0.5 miles along the LA River. The mile number and bank side are clear and helpful indicators for travelers and emergency responders.

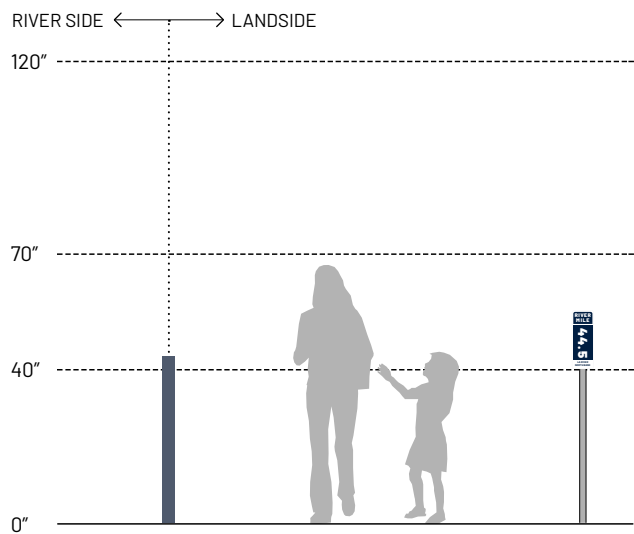


Figure 108. River mile markers should be located on the landside of the trail with the bottom of the sign 40" above grade.

## SIGN SPECIFICATIONS

- **Size:** 6x16" with 0.5" radius rounded corners
- **White border of sign:** 0.375" on all sides
- **Material:** Aluminum with anti-graffiti treatment
- **Background:** Pantone 282 C with 0.5" radius rounded corners
- **Margins within background:** 0.4375" minimum on all sides

## INSTALLATION

- On land side of trail, every 0.5 miles
- Bottom of sign located at 40" off the ground

## NOTES

- Two signs should be installed sandwiching the pole so that the sign faces both directions of travel
- Always confirm specifications with latest applicable guidelines

## RIVER MILE MARKERS

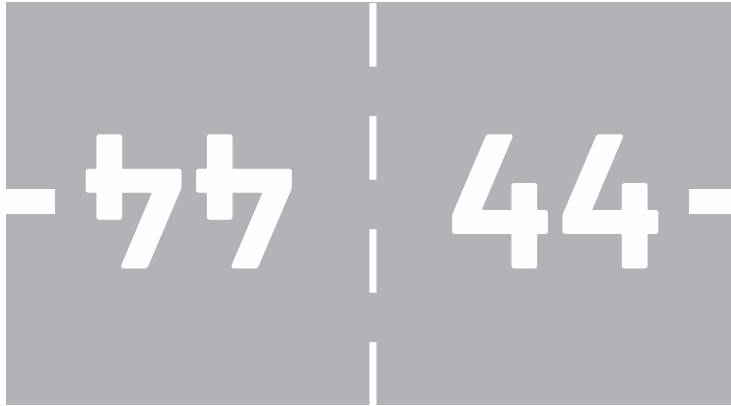
### PURPOSE

River Mile Markers are a new and important signage type to the LA River. A cohesive system of mile numbering along the LA River unifies all 51 miles and helps users identify their location along the river. Further, having consistent numbering strengthens public safety by allowing people to easily locate themselves along the river for emergency responders. River Mile Markers demarcate the distance from the outfall into the ocean (river mile 0) to the headwaters (river mile 51). River Mile Markers also indicate what side of the river someone is on. Bank sides are determined when looking north, up the river. Miles 0 to 30.5 are denoted as west and east banks, and at river mile 31, at the bend in the river, it switches to north and south banks.

### PLACEMENT

River mile markers should be placed every half mile, facing both directions of travel, along the trail on the landside of the trail. See page 148 for river mile placement guidelines.

## RIVER MILE PAVEMENT MARKINGS



### RIVER MILE NUMBER

**Font:** Barlow - Bold  
**Size:** 22" high  
**Color:** Pantone 282 C when on light concrete, white when on asphalt (match treatment of existing lines)  
**Position:** Center aligned in lane; 13" minimum on left and right to edge of trail and center of trail

### 1/10 MILE TICK

**Size:** 8" wide, 4" high  
**Color:** Pantone 282 C when on light concrete, white when on asphalt (match treatment of existing lines)  
**Position:** Right aligned, flush to edge of trail; center aligned vertically with river mile number

Figure 109. LA River mile pavement markings alert users to their river mile location along the river.

## INSTALLATION

- On ground of trail, facing both directions of travel
- Number occurs every mile, and tick on edges of trail occurs every 1/10 mile

## NOTES

- Color varies depending on color of trail paving, match treatment of existing lines

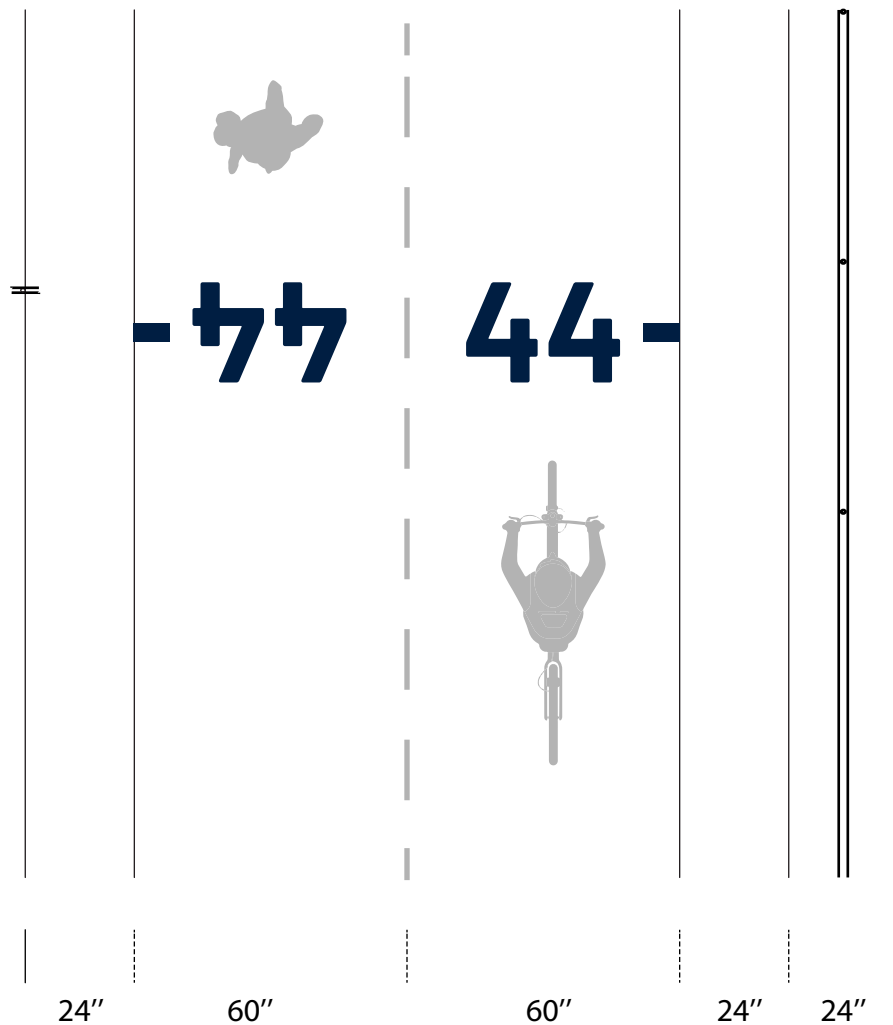


Figure 110. River mile pavement markings should be placed so that they face the direction of travel.

## RIVER MILE PAVEMENT MARKINGS

### PURPOSE

River Mile Pavement Markings occur on the pavement of multiuse trails along the LA River and demarcates the distance from the outfall into the ocean (river mile 0) to the headwaters (river mile 51). River Mile Pavement Markings should consist of either water-based or thermoplastic paint (contractor-grade acrylic striping paint, alkyd, or chlorinated rubber striping paint). Consider skid resistance, reflectivity, and durability when selecting materials, as well as ADA requirements for visibility. Refer to page 157 for more information on thermoplastic paint as necessary.

### PLACEMENT

River Mile Pavement Markings including the large mile number must be incorporated at every river mile on all paved paths along the LA River trail, including bikeways and multiuse trails, and facing both directions of travel. Every tenth of a mile shall be marked with only the horizontal ticks on both sides on far outsides of the path as well as in the middle of the path, not including the large mile number. See page 148 for river mile placement guidelines.

## RIVER MILE PLACEMENT

RIVER MILE	BRIDGE ROUTE NAME	RIVER MILE	BRIDGE ROUTE NAME	RIVER MILE	BRIDGE ROUTE NAME
51.0	Owensmouth Ave	35.8	Lankershim Blvd	18.9	Bandini Blvd
50.8	Canoga Ave	34.5	Barham Blvd	18.2	Union Pacific Rail
50.2	Desoto Ave	34.5	Warner Bros Studio Gate 7	18.2	Downey Rd
49.7	Mason Ave	32.8	State Route 134	17.2	Los Angeles Junction Rail
49.6	Vanowen St	31.6	Riverside Dr	16.6	Atlantic Blvd
49.2	Winnetka Ave	31.3	Interstate 5	15.8	Slauson Ave
48.7	Corbin Ave	30.6	State Route 134	15.3	Southern Pacific Rail
48.1	Tampa Ave	29.8	Colorado St Fwy Extension	15.1	Gage Ave
47.6	Wilbur Ave	28.4	Los Feliz Blvd	14.5	Florence Ave
47.1	Reseda Blvd	27.8	Glendale Blvd / Hyperion Ave	14.2	Clara St
46.6	Victory Blvd	27.0	Fletcher Dr	13.5	Southern Pacific Rail
46.5	Lindley Ave	26.7	State Route 2	13.3	Firestone Blvd
46.0	White Oak Ave	24.3	Interstate 5	12.6	Union Pacific Rail
45.5	Orange Line Busway	24.2	Riverside Dr	12.3	Interstate 710
44.9	Balboa Blvd	24.1	Metrolink	11.9	Imperial Highway
43.4	Burbank Blvd	24.1	State Route 110	10.6	Garfield Ave / W105
42.7	Interstate 405	23.6	Atchison, Topeka & Santa Fe Rail	10.0	Rosecrans Ave
42.5	Sepulveda Blvd	23.5	North Broadway	9.4	Somerset Blvd
41.9	Kester Ave	23.4	North Spring St	8.9	Alondra Blvd
41.4	Van Nuys Blvd	23.2	N Main St	8.5	Atlantic Ave
40.9	Highway 101	22.8	Southern Pacific Rail	8.0	State Route 91
40.9	Hazeltine Ave	22.3	Cesar E Chavez Ave	7.9	Artesia Blvd
40.3	Woodman Ave	22.2	US 101	6.7	Long Beach Blvd
39.9	Moorpark St	21.8	First St	5.8	Del Amo Blvd
39.7	Fulton Ave	21.3	Fourth St	5.3	Union Pacific Rail
39.2	Coldwater Canyon	20.9	Seventh St	4.8	Metro Blue Line
38.6	Whitsett Ave	20.5	Southern Pacific Rail	4.4	Interstate 405
38.0	Laurel Canyon Blvd	20.5	Interstate 10	4.0	Wardlow Rd
37.8	Radford Ave	20.2	Olympic Blvd	2.9	Willow St
37.7	Gilligan's Island Rd	19.7	Washington Blvd	1.9	State Route 1
37.3	Colfax Ave	19.6	Burlington Northern Santa Fe Rail	1.4	Anaheim St
36.8	Tujunga Ave	19.4	26th St	0.9	Long Beach Fwy
36.2	Vineland Ave	19.2	Soto St	0.3	Ocean Blvd
36.1	Highway 101			0.0	Queens Way

Figure 111. River miles at existing bridges over the LA River. Where a bridge is angled across the channel, localized judgement on a project basis is needed to determine if different river mile numbers should be used on opposite sides.

## RIVER MILE MARKER AND PAVEMENT MARKING PLACEMENT

The river miles follow the approximate centerline of the LA River as delineated by the USGS National Hydrography Dataset (NHD) starting at 0.0 at the river's mouth in Long Beach and continuing at tenths of a mile to river mile 51.0 in Canoga Park. The river mile dataset is available as part of the LA River Master Plan Geographic Information Systems (GIS) datasets. For these reference points to be useful for wayfinding and emergency management along the river, they can be projected from the center of the river to the banks.

River Mile Marker Signs should only be installed along the riverbanks at mile and half mile marks to provide a general reference point between the LA River Trail, the adjacent LA River, and other project sites and trails. Additional tenth mile points should be marked on the pavement of the LA River Trail.



## PLACING RIVER MILE MARKERS USING EXISTING BRIDGES






If a new project along the LA River is not adjacent to an already located river mile marker, the nearest bridge can be used as a general reference point (See Figure 109 on page 146). Start by drawing a line from the center of the bridge to either river bank, ensuring that the line is perpendicular to the river bank. From this point continue up the bank marking tenths of a mile until a river mile marker point, project site, or trail intersection point is met.

## PLACING RIVER MILES ALONG CURVED SEGMENTS

Similar to straight river segments, start by drawing a line from the center of the river to either river bank, ensuring that the line is perpendicular to the river bank. At curved river segments there is a slight compression in the actual mileage on the bank along the inside of a curve or slightly expanded actual mileage on the outside of a curve.

## DIFFERENTIATING RIVER MILES FROM ACTUAL TRAIL MILEAGE

River Mile Marker Signs and Pavement Markings are intended to be used as reference points for wayfinding and emergency management, not for calculating actual mileage traveled along the river. This distinction is also true of adjoining trails which may have their own mileage signage that is independent of the river mile system.

-  LA River Centerline
-  LA River Trail
-  River Mile Marker sign
-  Tenth Mile Pavement Marking
-  Adjacent Trail

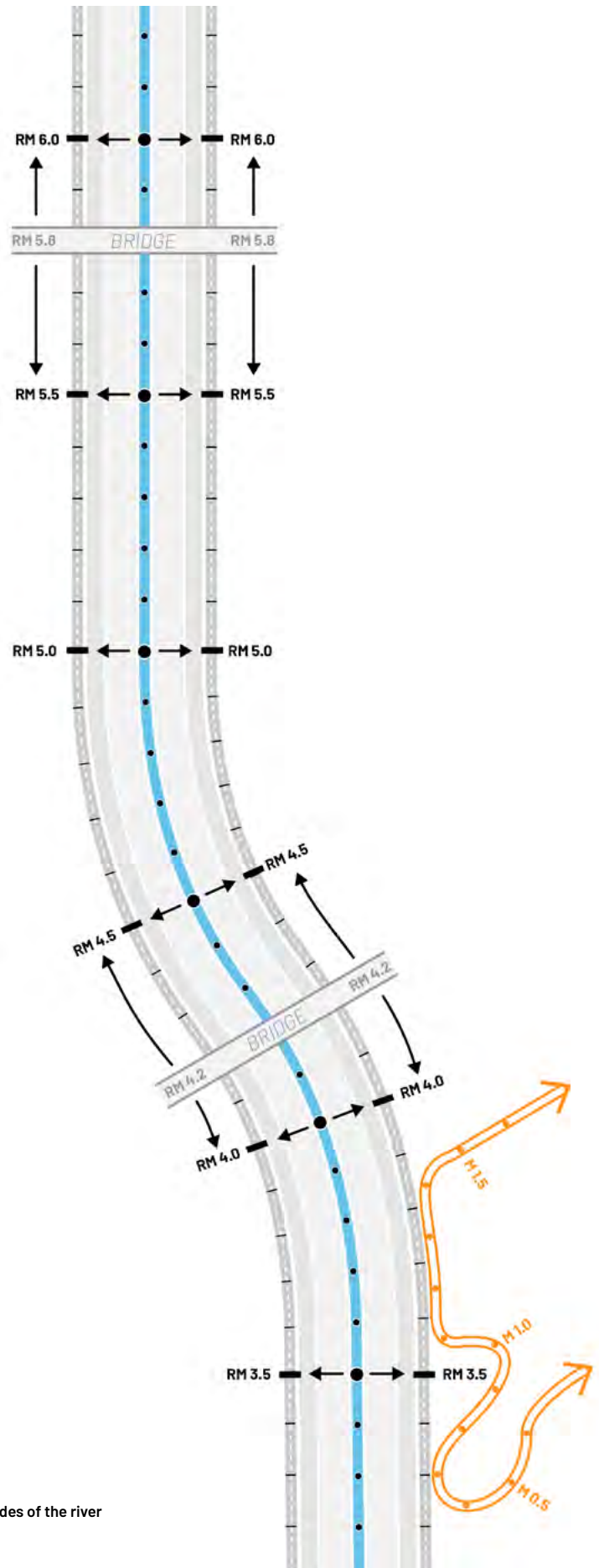


Figure 112. LA River trail river mile markers should be located along both sides of the river using existing bridges as benchmarks.

## LARGE SCALE ICON GRAPHICS



Figure 113. Underpasses are an opportunity for large scale icon graphics and can alert users to their river mile location.

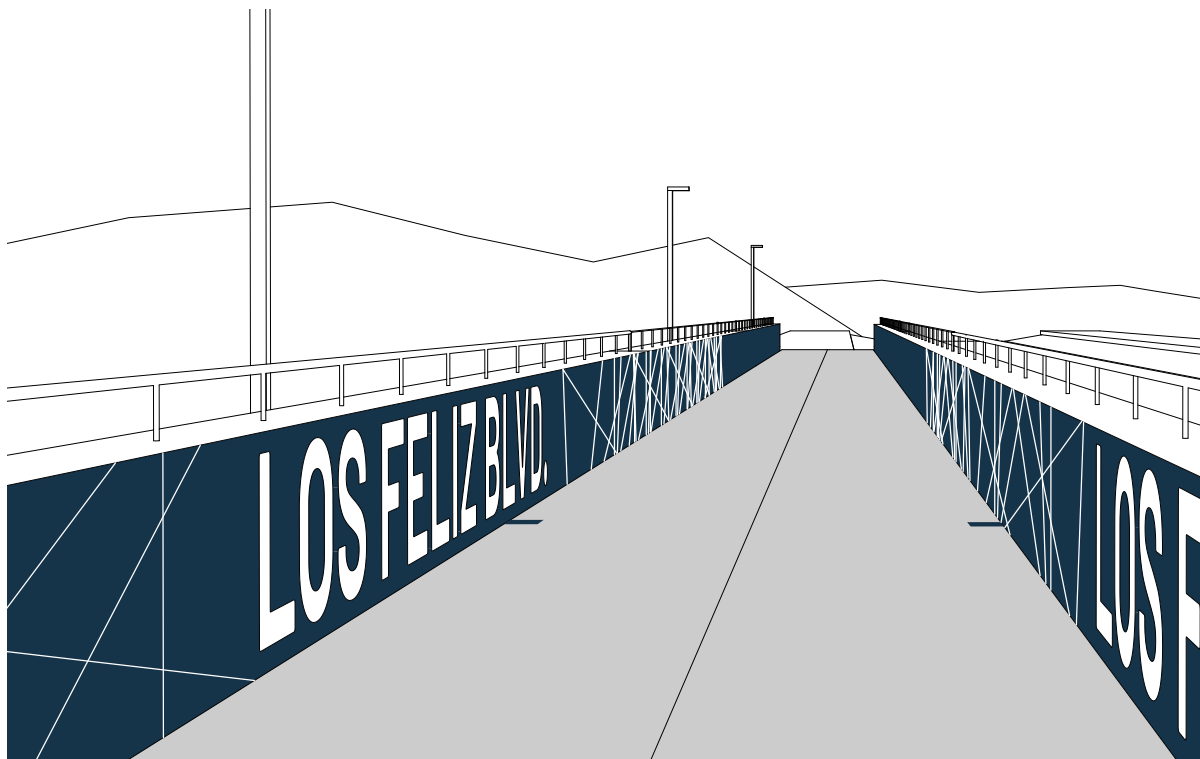


Figure 114. Bridges and overpasses are opportunities for large scale icon graphics and can alert users to street crossings underneath.

## LARGE SCALE ICON GRAPHICS

### PURPOSE

Integration with architecture, art, and design can best occur with creative use of large scale icon graphics. These environmental graphics are a critical component in the reduction of sign clutter, and can help inform users about their location along the trail or direct them to the LA River. Large scale icon graphics have the most flexibility in their expression and are a compelling way to incorporate art into wayfinding. Alternative wall treatments, such as textured finishes and vine planting can also be considered.

### PLACEMENT

Placement of large scale icon graphics is up to the discretion of the artist(s). They could be placed along blank walls, underpasses, or other key moments to highlight the river mile number or adjacent communities.

## PAVEMENT MARKINGS

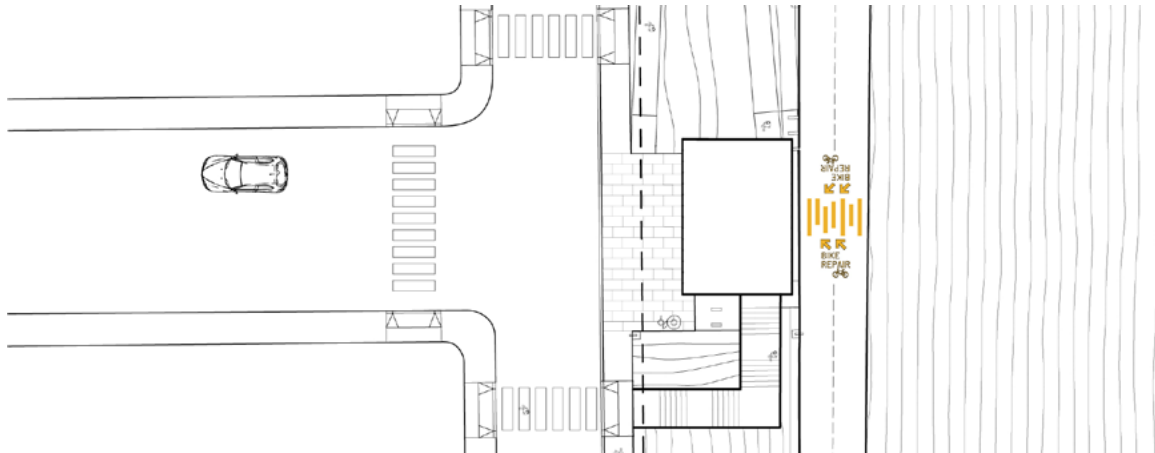


Figure 115. Pavement Markings can be customized along the LA River trail at gateways to allow for the integration of community expression.

## COMMUNITY EXPRESSION

Within the suite of LA River environmental graphics, there are opportunities for unique community expression. This provides an opportunity for local artists and youth to customize and contribute environmental graphics that reflect their stories and identities. Artist involvement can be combined with community engagement efforts and help to foster a sense of stewardship in younger generations.

Certain elements can be customized, while other elements should stay consistent for legibility and clarity in wayfinding.

The following types of environmental graphics must be consistent throughout the LA River:

- Regulatory
- Confirmation
- Directional
- River Mile Markers
- River Mile Pavement Markings

The following types of environmental graphics can be modified for an individual project or artist collaboration as long as certain elements remain consistent:

- Pavement Markings
- Informational
- Interpretive signs and displays
- Large Scale Icon Graphics

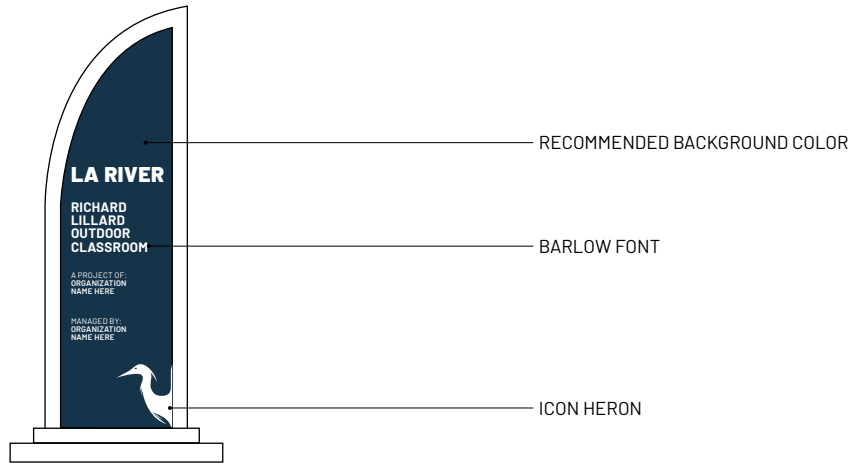
Within the signs that can be modified, the following elements should remain consistent:

- Barlow font
- Heron symbol or icon
- The required background color (the color variation in natural uncoated materials and other neutral colors are allowed)

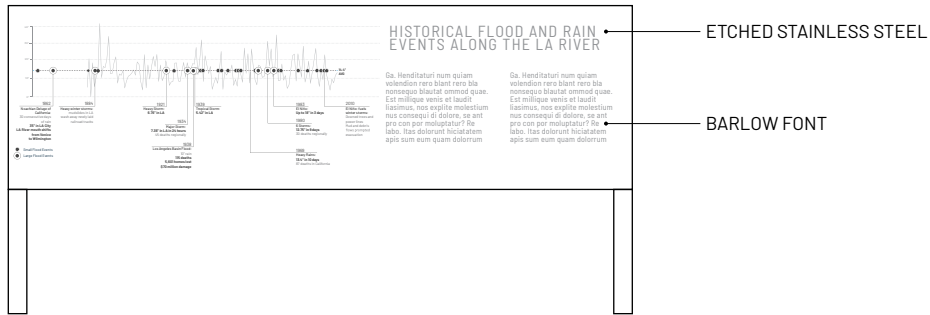
An exception is with large scale icon graphics, where the artist(s) have discretion on the final product. Materials in these four types of environmental graphics can be modified as long as they are water quality compliant (non-toxic and will not leach off into the river). Further, the form and content of the environmental graphics can be modified.

**ENVIRONMENTAL GRAPHICS, AS WELL AS OTHER FORMS OF COMMUNITY EXPRESSION THAT ADHERE TO THESE GUIDELINES, CAN BE CUSTOMIZED FOR EACH PROJECT**

## INFORMATIONAL EXAMPLE



## INTERPRETIVE EXAMPLE



## LARGE SCALE ICON GRAPHICS EXAMPLE

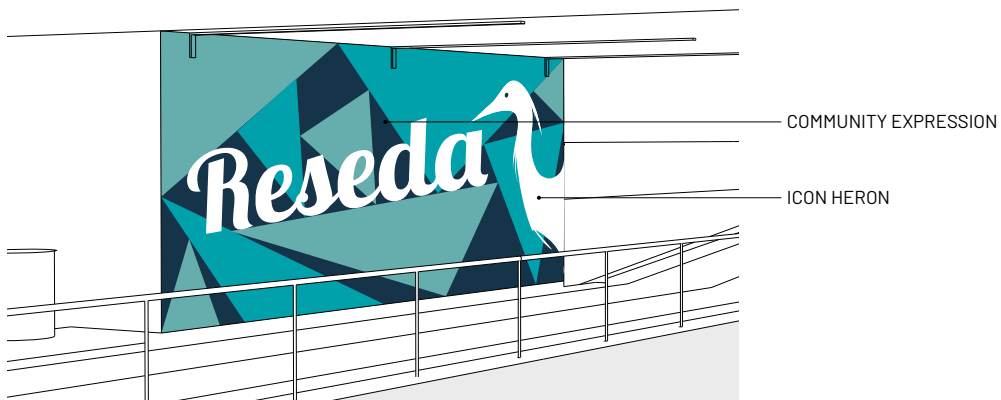


Figure 116. Elements of informational environmental graphics, interpretive signs and displays, and large scale icon graphics can all be customized for specific projects. Designers can create their own approaches within the outlined parameters on a project by project basis.

## INSTALLATION & MAINTENANCE

Responsibility for maintaining signs should be determined prior to installation. Agencies may have requirements for inventory of signs within their jurisdiction. The Operational Services Division of LA County Public Works should be notified appropriately of all signs that they will be responsible for maintaining.

Required maintenance consists of regular inspections for vandalism, cleaning and repair as necessary and periodic replacement. A UV coating on aluminum inhibits fading of sign colors, but aluminum signs likely will need replacement after five to ten years. Frequent vandalism may shorten the lifespan.

### SIGN MOUNTING

Where possible, signs should be mounted onto existing posts. For brand new sign installation for either new sign types or in completely new projects, these guidelines should be followed:

- Posts should be steel tube posts with finish matching RAL 9007.
- The post cap should be made from welded aluminum with all edges and corners neatly finished.
- The sign should be mounted to bracket with tamper-proof bolts, lock washers, and nuts.
- Natural rock bases or podiums should be avoided due to maintenance concerns.



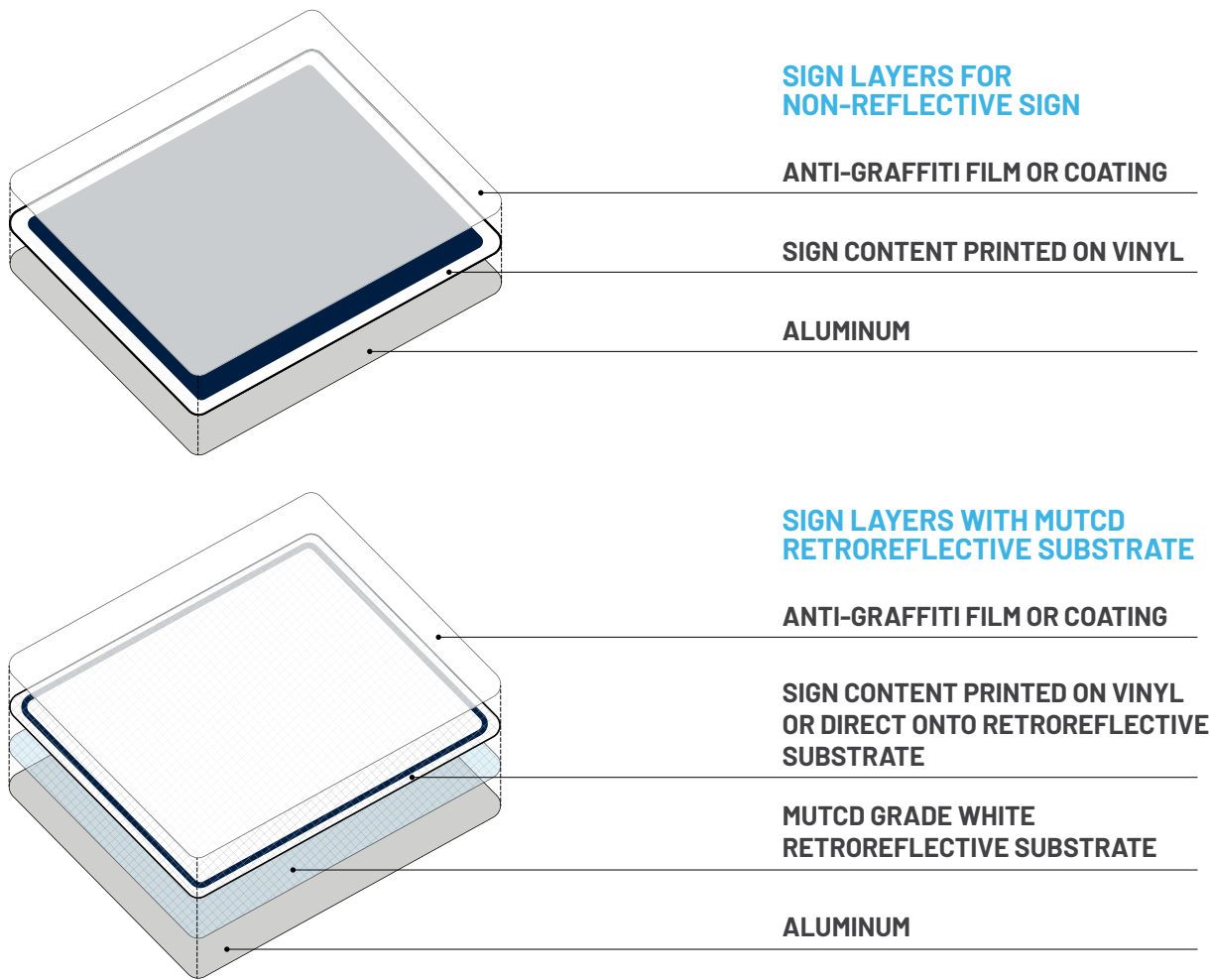


Figure 117. Common layers of an aluminum sign include anti-graffiti film or coating, printed vinyl, and retroreflective substrate on aluminum. The best application of applied graphics using vinyl or print is to be determined by fabricator. Always confirm with the fabricator that graphics are protected for exterior environments.

## VANDALISM

Much of the environmental graphics installed along the LA River will likely be vandalized at some point. Typical vandalism may be spray paint, etching or other destruction. Regular and diligent inspection of all signs is recommended weekly. At the time of inspection, if vandalism is found, it should be immediately repaired or cleaned.

Aluminum signs are to be manufactured with an anti-graffiti treatment. Anti-graffiti films and coatings must be specified to have a satin, non-glare finish for ADA compliance. The treatment allows spray paint to be cleaned off using commercial products that are applied directly to the sign to wipe off spray paint. Anti-graffiti coatings can be also used to add a clear, non-stick, protective coating to painted wood, aluminum, metal, masonry, bricks, concrete, and stone. This treatment can be used for large scale icon graphics such as murals.



Figure 118. Aluminum with rounded corners is used as the base of many types of signs. Source: OLIN, 2019.



Figure 119. Retroreflective substrates, colored film, and clear anti-graffiti film layer on top of aluminum to create the graphic of a sign. Source: OLIN, 2019.

## RAL 9007



Figure 120. New sign posts should be RAL 9007.

## MATERIALS

The materials used for environmental graphics are very important for its consistency and performance once installed. Required materials for the signs in these guidelines are 0.080" thick aluminum with rounded corners and an anti-graffiti treatment. Anti-graffiti film provides a cleanable and clear layer on top of the graphics of a sign, and if damage is severe enough can be a layer that is removed entirely for ease of maintenance. High performance anti-graffiti coatings can also be used, and protects a sign's top surface allowing for easy cleaning and maintenance. Always confirm with the fabricator that graphics are protected for exterior environments, including UV protection to avoid fading. Best application of applied graphics using vinyl or direct print to be determined by fabricator.

A retroreflective substrate should only be used on all Bicycle Route Directional environmental graphics per MUTCD requirements. Refer to latest MUTCD guidelines for the most current level of retroreflectivity requirements.

## PAVEMENT MARKING PAINT

<p><b>WATER-BASED</b></p> <ul style="list-style-type: none"> <li>• ENVIRONMENTAL IMPACT: Low</li> <li>• COST: Medium</li> <li>• DURABILITY: Medium</li> </ul>	<p><b>SOLVENT-BASED</b></p> <ul style="list-style-type: none"> <li>• ENVIRONMENTAL IMPACT: High</li> <li>• COST: Low</li> <li>• DURABILITY: High</li> </ul>
<p><b>THERMOPLASTIC</b></p> <ul style="list-style-type: none"> <li>• ENVIRONMENTAL IMPACT: Low</li> <li>• COST: High</li> <li>• DURABILITY: Very High</li> </ul>	<p><b>COLD PLASTIC</b></p> <ul style="list-style-type: none"> <li>• ENVIRONMENTAL IMPACT: Low</li> <li>• COST: Medium</li> <li>• DURABILITY: Medium</li> </ul>
<p><b>Recommended</b></p>	

Figure 121. There are many options of paint for River Mile Pavement Markings. Thermoplastic and water-based paints are recommended for use along the LA River based on their durability and environmental impact.



Figure 122. Thermoplastic paint is a durable option for River Mile Pavement Markings on asphalt. Source: LeManna, 2020.

## BIKE TRAIL PAINT

Where possible, paints should be chosen for low environmental impact while balancing out initial and long-term O&M costs. The main types of paint include: water-based (e.g., acrylic), solvent-based, thermoplastic, and cold plastic. They are all applicable to asphalt and concrete and require primer before application. Reflective beads can be added to most types of paint to increase reflectivity.

Water-based paints have the lowest environmental impact in production, application, and removal. When freezing temperatures are not a concern, water-based paints are similar to durability as solvent-based paints.

When specifying for bike trail paint, note the following considerations, though many more exist and should be researched before final specifications are written: water-based paint should be specified as lead-free; solvent-based and thermoplastic paints should be specified with various volatile organic compound (VOC) compliance standards depending on the additive (epoxy, polyurea, acetone, etc.); Caltrans and Federal Type I approved paint lists can be referenced and are widely available (the main difference between Federal and Caltrans approved guidelines are freezing temperature durability and differences in VOC compliance). Additional additives for texture and durability should be consulted for each type of paint, especially thermoplastics.

# ENVIRONMENTAL GRAPHICS CHECKLIST

Reference the LACFCD and Public Works Permitting checklist on page 34 for an overview of project permitting and applicable codes.

## Detailed Technical Requirements Checklist for Environmental Graphics

### Standard Design Features

- Provide technical drawings showing signs matching specified requirements for current ADA font, size, contrast, bilingual content, braille, and Indigenous Peoples references per the Environmental Graphics Permitting Matrix on page 118.
- Follow sign design template files available for download here: (Final link to be included in final guidelines).
- Ensure that any custom modifications occur only in these environmental graphics categories: Informational, Interpretive signs and displays, and Large Scale Icon Graphics. Further, ensure that consistent elements are followed.

### Placement and Sequence of Environmental Graphics

- Avoid sign clutter where possible.
- Follow placement of signs as recommended in Chapter 4. Show proposed sign placements in plan.
- Define scale of project (XS, S, M, L, XL - further defined in programming section in Chapter 2). Ensure lateral wayfinding and environmental graphics within project are installed leading to the project per the Environmental Graphics Permitting Matrix on page 118.
- Show that proposed heights of signs follow the recommendations for the appropriate category in this chapter.

### **Detailed Maintenance Program Checklist for Environmental Graphics**

- Define jurisdiction responsible for ongoing maintenance and repair of environmental graphics.
- Specify appropriate anti-graffiti and UV resistant treatment.
- Establish schedule for routine checks for vandalism, graffiti, or weathering (recommended on a weekly basis). Address minor fixes or replace signs as needed.





**Figure 123. Vegetation Classification.** Much of the vegetation around the LA River is degraded or mostly comprised of non-native plant species.  
 Source: LA River Master Plan, 2020.



# 5.

## ECOLOGY, HABITAT, AND PLANTING

**THE RIVER'S CAPACITY TO SUPPORT  
NATIVE HABITATS IS DETERMINED BY  
CONDITIONS UNIQUE TO EACH FRAME,  
FROM ITS CHANNEL SHAPE TO URBAN  
CONTEXT TO HYDROLOGIC CONDITIONS**

Despite being highly urbanized, the LA River watershed sits within one of the world's most diverse Mediterranean biodiversity hotspots. The river's capacity to support biological life is determined by hydrological conditions, channel geometry, and connectivity across and along the river to adjacent patches and habitat areas. The guidelines for ecology and planting are thus guided by the unique biodiversity of the region and characteristics of the river's distinct reaches.

With further connectivity and habitat enhancement, the river has the potential to increase urban biodiversity given the high natural biodiversity occurring nearby in the region's large inland protected areas. Additionally, elements of the river's former ecology can be reintroduced where appropriate to reestablish many of the rare riparian and upland ecosystems that have been lost to urbanization. However, the resilience of these native ecosystems to changes in hydrology and climate should also be considered and, where needed, planting palettes should be augmented and adaptively managed.

# WHAT'S IN THE CHAPTER

The following pages contain the guidelines for the design and installation of planting along the LA River. This chapter will provide information regarding planting setbacks and buffers, planting along levees and floodwalls, and channel modifications, among other aspects related to the creation of habitats and functioning ecosystems. Further, extensive LA River plant community lists are in this chapter, described in detail starting on page 208.

The designer or engineer shall be responsible for ensuring the implementation of these guidelines is compliant with prevailing building codes and regulations. Consult the checklist at the end of the chapter to ensure the correct guideline items are followed.

<b>161</b>	<b>5. Ecology, Habitat, and Planting</b>		
162	What's in the Chapter	188	Platform Parks
164	Considerations for Ecological Project Success	190	Productive Landscapes
		193	Tree and Plant Protection
166	Setbacks and Buffers	194	Site Preparation and Soil
168	Planting Along Levees and Floodwalls	196	Tree and Shrub Planting
		198	Maintenance Best Practices
170	Maintenance Buffers and Clearances	200	Walls
		203	Slope Stabilization and Erosion Management
172	Rights-of-Way		
174	Safety Best Practices Along the River	204	Wildfire
		206	Strategies for Creating Habitat
176	Planted Buffers	210	Habitat Areas: Off-Channel Fishing Amenities
178	Stormwater Best Management Practices		
		212	Plant Communities
183	Channel Modifications: Innovation	214	Native Plant Species Appropriate Use
184	Channel Modifications: Trapezoidal Channel	216	Planting Lists
186	Channel Modifications: Rectangular Channel	316	Ecology, Habitat, and Planting Checklist

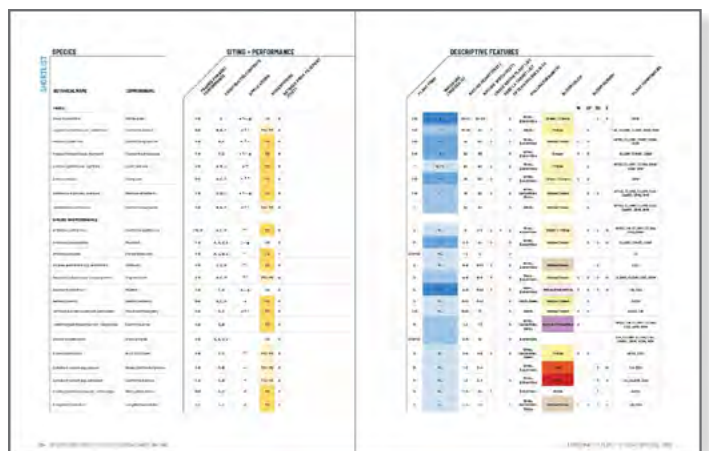
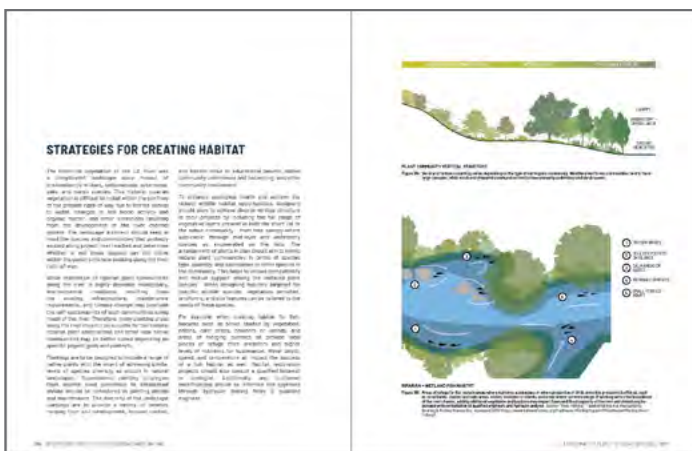
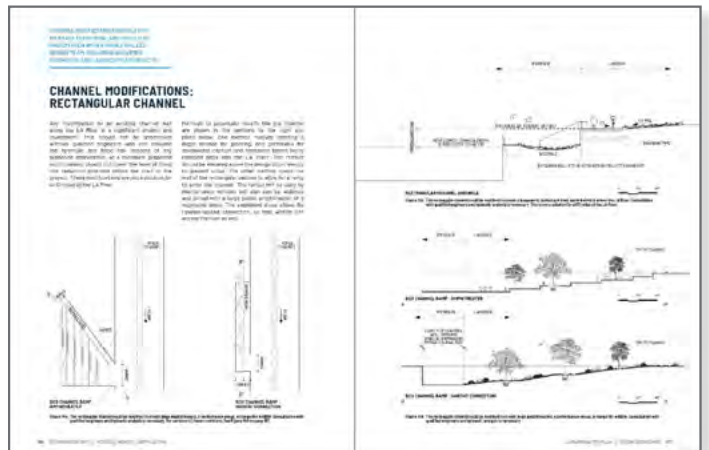
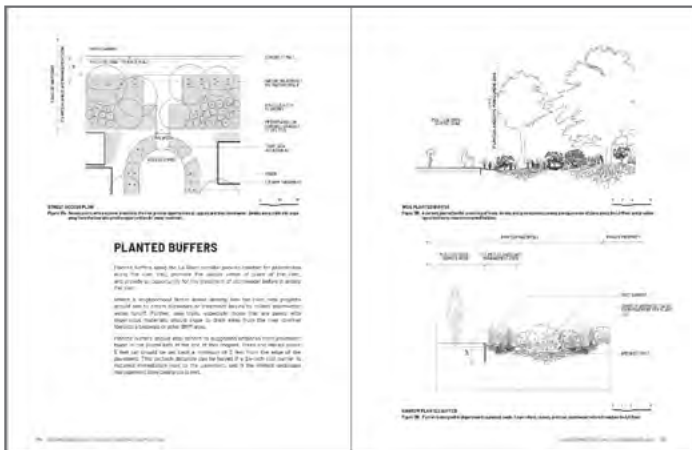
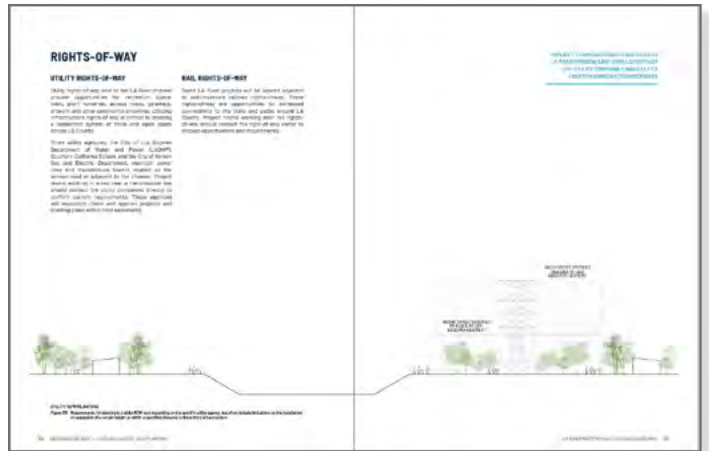
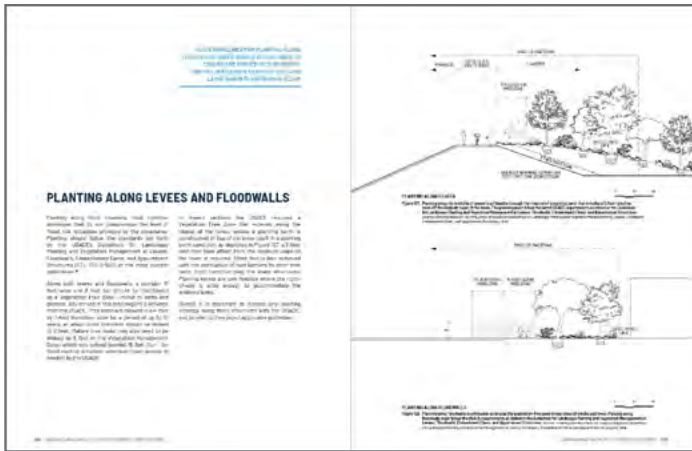


Figure 124. Chapter 5 of this document covers items related to ecology, habitat, and planting in and along the LA River.

DESIGNERS SHOULD PLANT SPECIES  
APPROPRIATE TO THE PROJECT'S  
PLANNING FRAME, AND PROVIDE  
SUCCESSIONAL DEVELOPMENT OF  
PLANTINGS INTO COMMUNITIES OF PLANTS

---

## CONSIDERATIONS FOR ECOLOGICAL PROJECT SUCCESS

To ensure success in habitat and planting projects along the LA River, design considerations must include everything from site preparation to sourcing plant material to post-installation maintenance. These guidelines put forward the following values for projects along the river:

- Plant species appropriate to the planning frame of the project.
- Provide successional development of plantings into communities of plants that are ultimately best suited to the conditions of their environment.
- Provide a continuous native tree and plant corridor along the river with linkages to riparian habitat and upland areas in close proximity to the river.
- Support nurseries and organizations that specifically collect and propagate indigenous native plant species for planting along the river corridor.
- Achieve healthy soil biology, not just chemistry, by providing the critical foundation for each stage of succession that will ultimately host a sound ecological system.
- Eradicate invasive species, and deter the use of non-native species that provide little or no habitat value.
- Encourage the use of permeable paving solutions, filtration and percolation of rainwater, and on site water retention/detention to mitigate/eliminate water pollution and to reduce runoff.
- Consider the resilience of the LA River system and the future effects of climate change in project planning and design.
- Ensure there is a maintenance plan for the installed landscape that is appropriate to the needs of the planted species.
- Provide opportunities for artwork through habitat creation and planting.

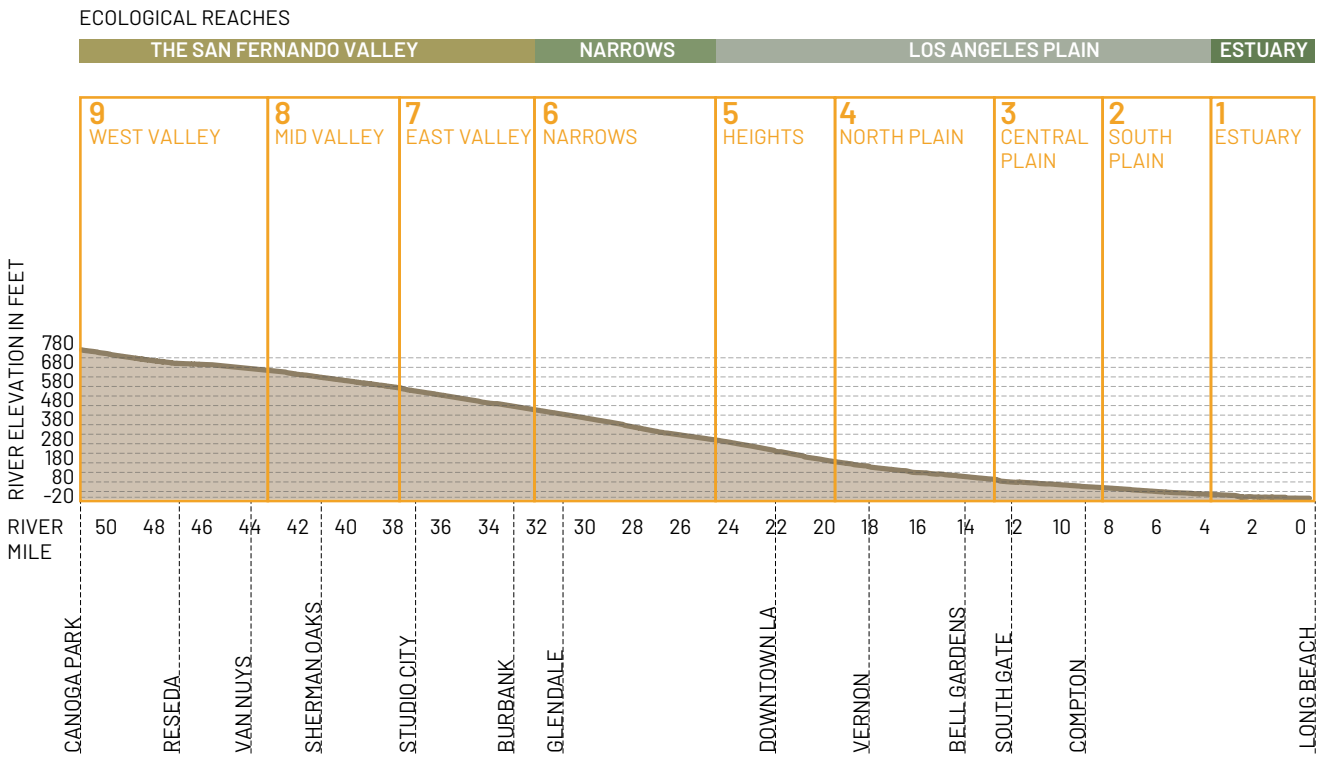


Figure 125. Depicted here with a 4x vertical exaggeration, the LA River changes approximately 780 feet in elevation over its course of 51 miles and passes through several distinct ecological reaches, from the San Fernando Valley to the Estuary.

**THE LIMITED LANDSCAPE  
MANAGEMENT ZONE, SET 17 FEET BACK  
FROM ANY ENTRENCHED CHANNEL  
WALL, LIMITS PLANTING IN THIS  
ZONE TO SHRUBS AND GROUND COVER  
NOT TO EXCEED 3-5 FEET IN HEIGHT**

---

## SETBACKS AND BUFFERS

Planting along the LA River corridor is affected by various setback requirements necessary for the maintenance of its function as a flood channel. Additionally, there are opportunities for planting to serve as a buffer from the urban context of the LA River, including best management practices (BMPs) for the capture and treatment of stormwater runoff.

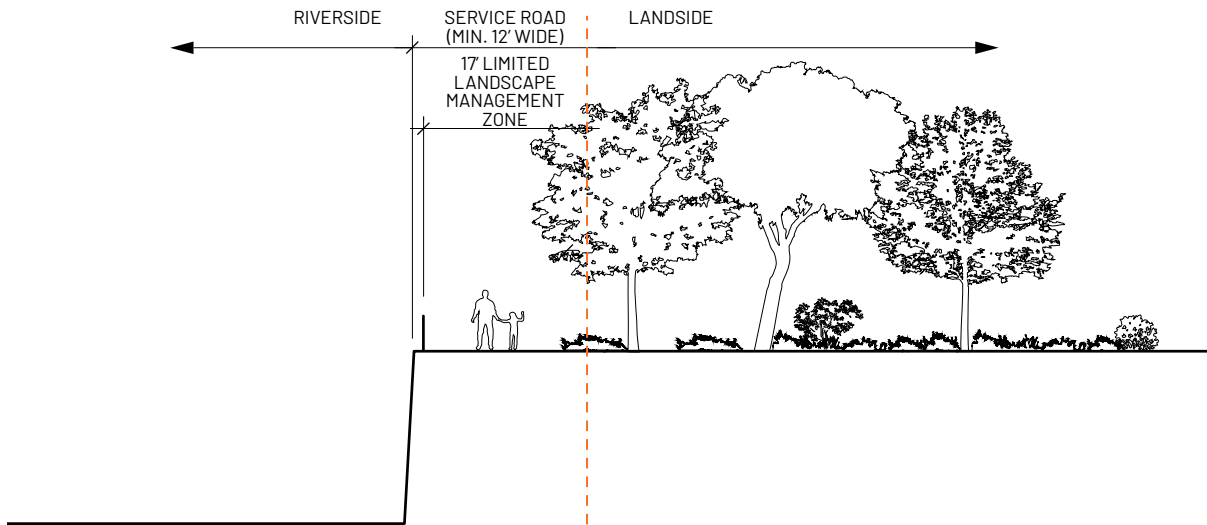
There are two types of buffers along the LA River channels, and further details on the USACE's Vegetation Free Zone requirements for buffers are located on the following pages. Although some existing conditions providing for maintenance along the top of the channels may not comply with those stated in this document, all proposed new projects shall comply with these guidelines. Any variance shall be reviewed and approved by the appropriate jurisdiction.

The Limited Landscape Management Zone is an important setback needed for any service road along the entrenched portions of the LA River channel to provide clearance for maintenance and emergency vehicle access (Figure 126). This zone is designated to extend 17 feet from the channel wall and prohibits any structures or obstructions. Plantings or structures in this zone may be heavily disturbed or removed if repair or emergency access is required. Plantings in this zone are restricted to low growing species, not to exceed 3-5 feet in height. Trees and shrubs outside this zone are not subject to these size restrictions. This zone also includes the required 12-foot minimum service road width.

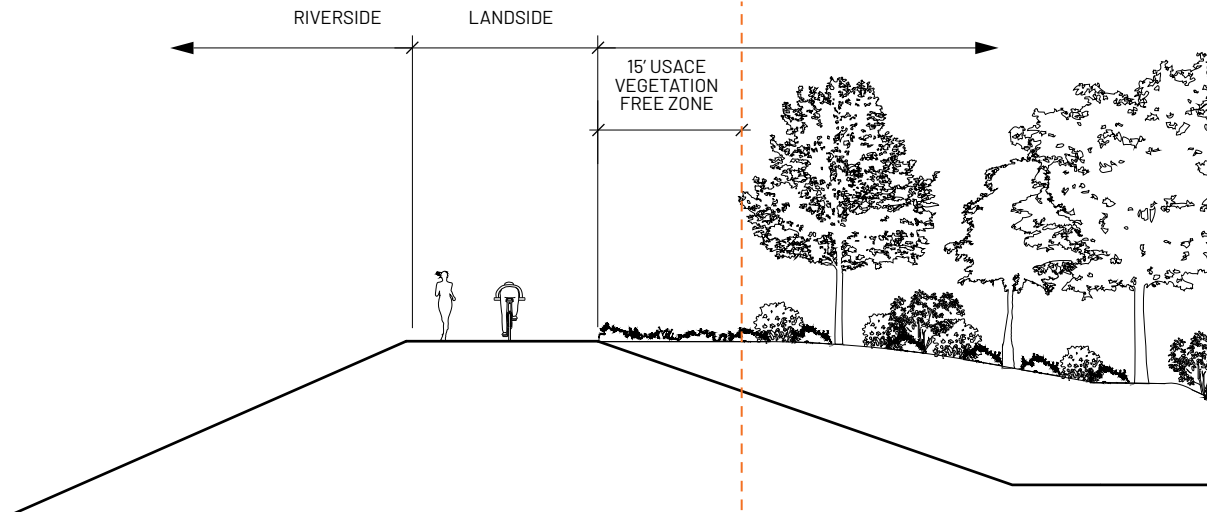
Planting areas against the channel walls, such as the ones shown in Figure 126, may be considered if they are planted with low shrubs (18 inches or less), ground cover, and grasses (no trees or large woody shrubs). Further, these planting areas may be located between expansion joints but not directly behind one, at a minimum of 5 feet from an expansion joint.



**VEGETATION SETBACKS ALONG EXISTING ENTRENCHED PORTIONS OF THE RIVER**



**VEGETATION SETBACKS ALONG EXISTING LEVEED PORTIONS OF THE RIVER**



**VEGETATION SETBACKS ALONG EXISTING OR PROPOSED FLOODWALLS ADJACENT TO THE RIVER**

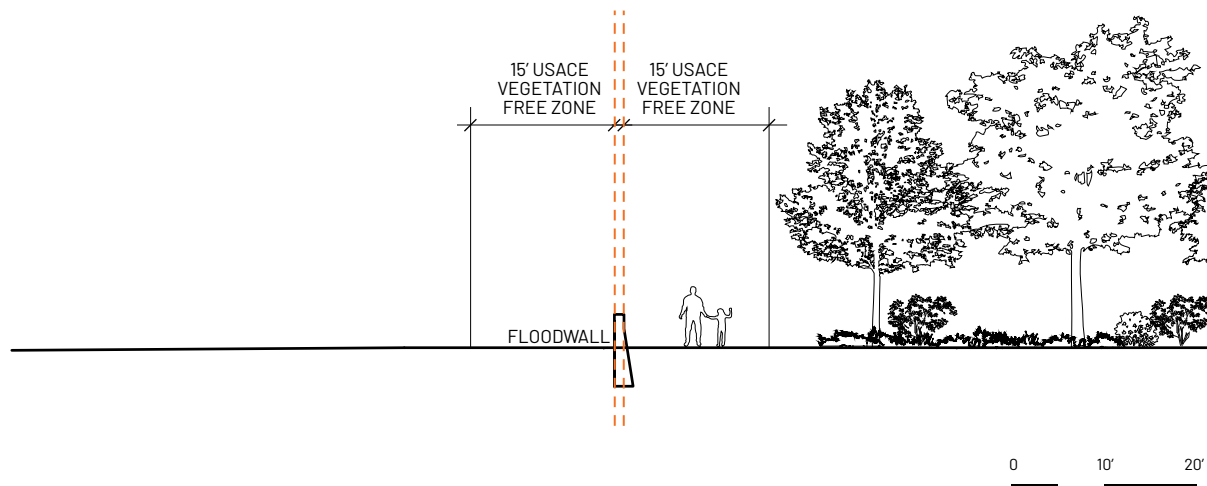


Figure 126. Along entrenched portions of the channel, the LACFCD requires a 17-foot Limited Landscape Management Zone that prohibits any structures and limits planting to shrubs and groundcovers up to 3-5 feet in height. The USACE guidelines require a 15-foot Vegetation Free Zone that limits planting to grasses and shallow-rooting perennials near levees or floodwalls. This distance is measured from either the landside edge of the levee, the top of a levee with a planting berm, or from the edge of a floodwall.

USACE GUIDELINES FOR PLANTING ALONG FLOOD STRUCTURES SHOULD BE FOLLOWED TO ENSURE THE STRUCTURE'S INTEGRITY. THIS INCLUDES LIMITS TO WHERE TREE AND LARGE SHRUB PLANTING MAY OCCUR

---

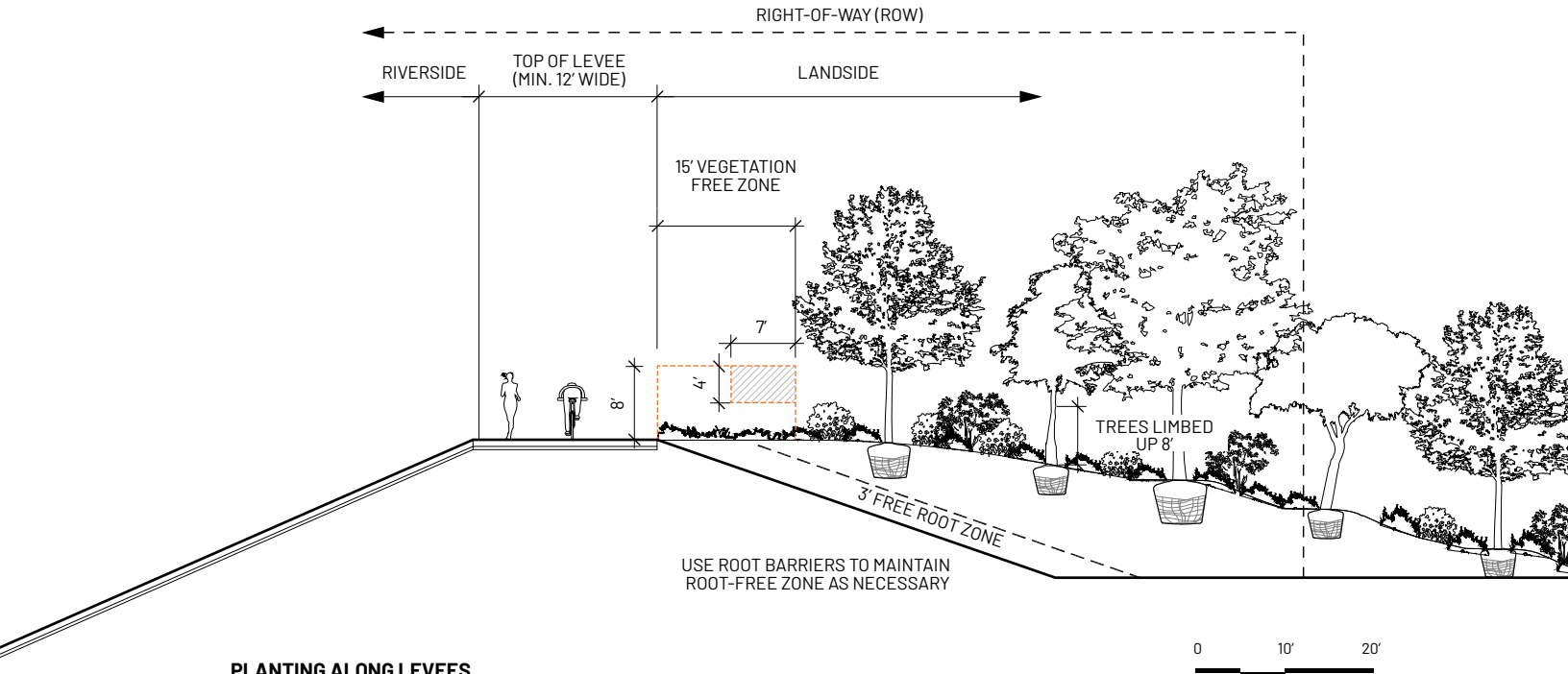
## PLANTING ALONG LEVEES AND FLOODWALLS

Planting along flood channels must consider strategies that do not compromise the level of flood risk reduction provided by the structures. Planting should follow the standards set forth by the USACE's Guidelines for Landscape Planting and Vegetation Management at Levees, Floodwalls, Embankment Dams, and Appurtenant Structures (ETL 1110-2-583) or the most current publication.<sup>19</sup>

Along both levees and floodwalls, a corridor 15 feet wide and 8 feet tall should be maintained as a Vegetation Free Zone, limited to forbs and grasses. Any shrubs in this area require a variance from the USACE. Tree limbs are allowed in a 4-foot by 7-foot transition zone for a period of up to 10 years, at which point branches should be limbed to 8 feet. Mature tree limbs may also need to be limbed to 8 feet in the Vegetation Management Zone, which can extend beyond 15 feet from the flood control structure wherever clear access is needed by the USACE.

In leveed sections the USACE requires a Vegetation Free Zone that extends along the slopes of the levee, unless a planting berm is constructed on top of the levee itself. In a planting berm condition, as depicted in Figure 127, a 3-foot root-free zone offset from the landside slope of the levee is required. Often this is also achieved with the installation of root barriers to deter tree roots from compromising the levee structures. Planting berms are only feasible where the right-of-way is wide enough to accommodate the widened levee.

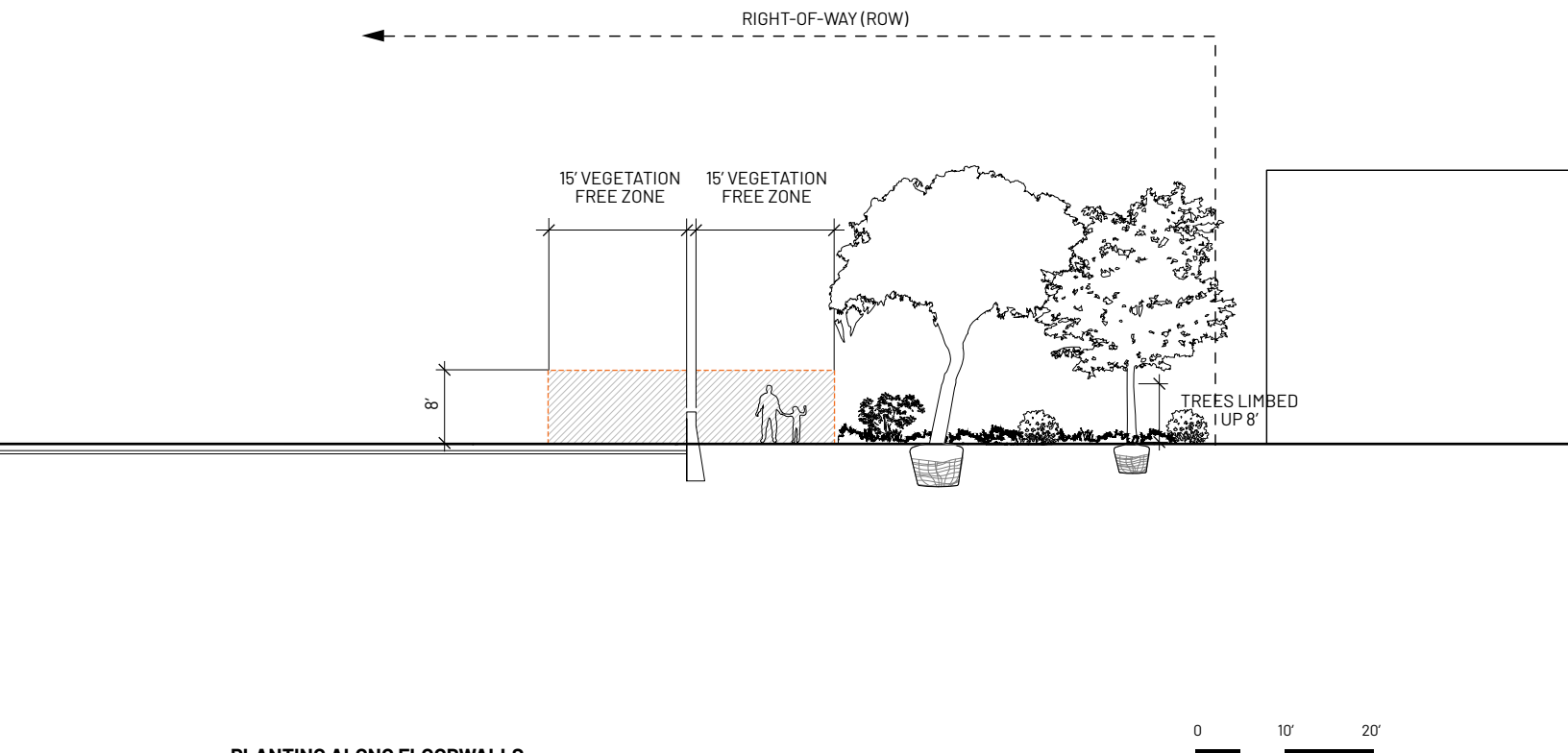
Overall it is important to discuss any planting strategy along flood structures with the USACE, and to refer to their latest applicable guidelines.



**PLANTING ALONG LEVEES**

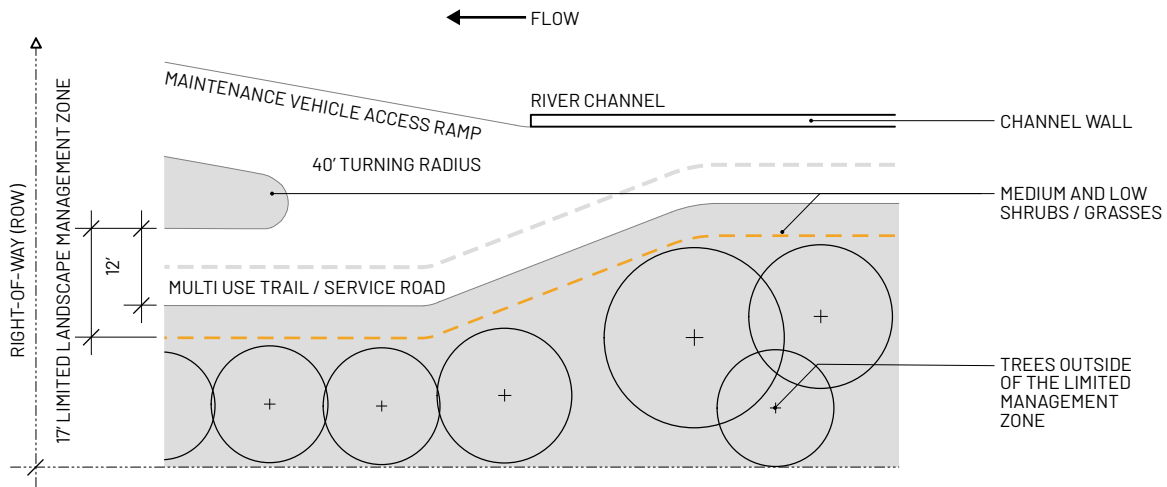
Figure 127. Planting along the landside of levees is achievable through the creation of a planting berm that includes a 3-foot root-free zone off the landside slope of the levee. This planting must follow the latest USACE requirements as stated in the Guidelines for Landscape Planting and Vegetation Management at Levees, Floodwalls, Embankment Dams, and Appurtenant Structures.

Source: Drawing based on US Army Corps of Engineers Guidelines for Landscape Planting and Vegetation Management at Levees, Floodwalls, Embankment Dams, and Appurtenant Structures, 2014.



**PLANTING ALONG FLOODWALLS**

Figure 128. Planting along floodwalls is achievable as long as the vegetation-free zone is kept clear of shrubs and trees. Planting along floodwalls must follow the USACE requirements as stated in the Guidelines for Landscape Planting and Vegetation Management at Levees, Floodwalls, Embankment Dams, and Appurtenant Structures. Source: Drawing based on US Army Corps of Engineers Guidelines for Landscape Planting and Vegetation Management at Levees, Floodwalls, Embankment Dams, and Appurtenant Structures, 2014.



### MAINTENANCE ACCESS TO RIVER CHANNEL

Figure 129. Proper ingress and egress clearance must be allowed for maintenance vehicles. The above example considers requirements for a maintenance ramp into an entrenched portion of the river channel, which includes, but is not limited to, the turning radius, direction of flow, and the limited landscape management zone.

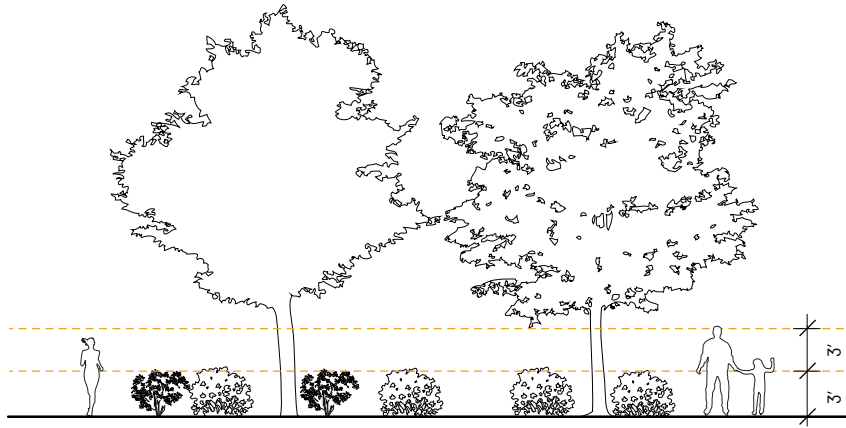
## MAINTENANCE BUFFERS AND CLEARANCES

Maintenance vehicles require adequate access and space to maneuver in order to service the flood channel. The following additional clearances should be followed in the absence of criteria from the local agency of jurisdiction:

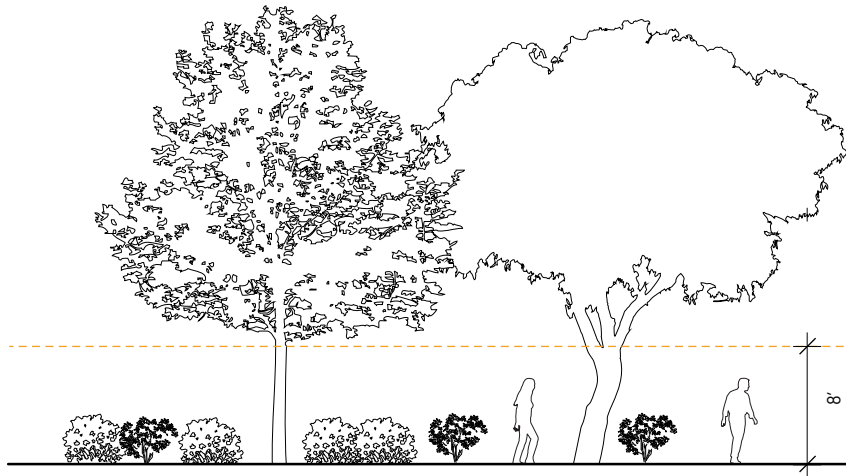
- All maintenance vehicles must have ingress/egress clearance at all times.
- Any alteration/design of service roads must meet with county approval.
- 40-foot centerline turning radius for truck ingress and egress from arterial streets.
- A minimum 4-foot trees and tall shrub setback from the sidewalk adjacent to vehicular ingress/egress from arterial streets.
- Vehicular access gates are to be set back 20 feet from the arterial street curb when available and feasible.

Limbing-up mature trees also helps to provide maintenance access and recreational use. Where multiple limb heights apply, tree limbing should be coordinated so that the highest requirement is met where applicable. In general, trees should not be pruned during their establishment period. When the tree trunk reaches a 4-inch diameter at breast height, those trees that overhang the service road or trail may then be pruned up to provide clear access or sight lines. At access points and trails intersections, mature trees should be limbed up to a minimum of 6 feet. Trees that fall within the Vegetation Management Zone, or whose branches fall into the Vegetation-Free Zone as defined by the USACE standards (ETL 1110-2-583), should be limbed up to 8 feet at maturity.<sup>20</sup> Currently the USACE allows a maximum of 10 years for trees to mature without limbing. Any tree branches that directly overhang equestrian trails should be limbed up to a minimum of 12 feet.

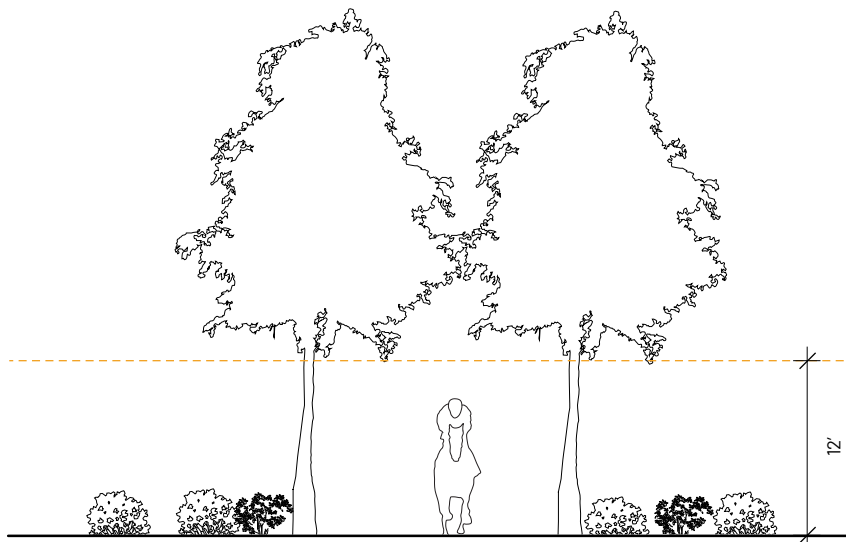
TREE LIMBING SHOULD BE COORDINATED SO THAT THE GREATEST APPLICABLE HEIGHT IS MET WHERE NEEDED OR WHERE OVERLAPPING REQUIREMENTS OCCUR. TREE LIMBING SHOULD NOT OCCUR BEFORE THE TREE HAS REACHED MATURITY



**SAFETY / VISIBILITY BEST PRACTICE**



**USACE MAINTENANCE REQUIREMENTS**



**ABOVE EQUESTRIAN TRAILS ONLY**



Figure 130. Tree limbing height requirements vary based on the location of the tree, the programmed use of the area, and visibility requirements. Young trees are exempt from these requirements and should not be limbed until they have reached maturity.

# RIGHTS-OF-WAY

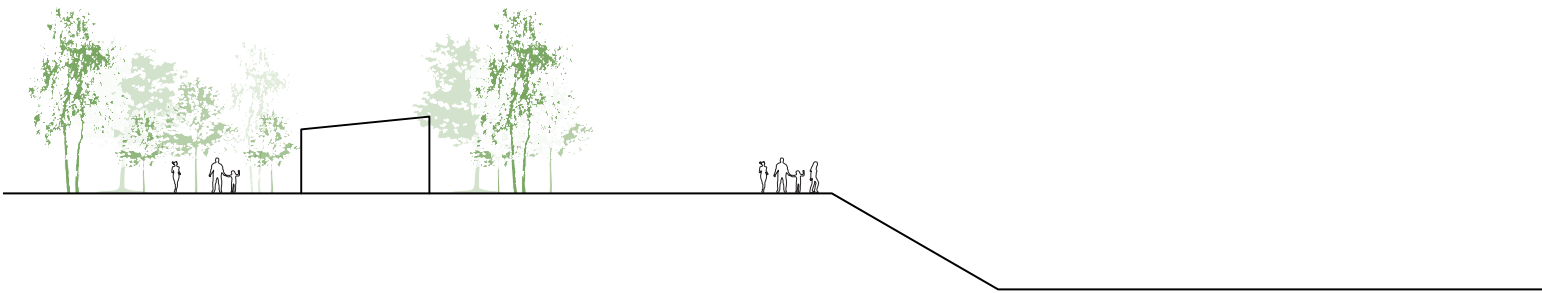
## UTILITY RIGHTS-OF-WAY

Utility rights-of-way next to the LA River channel provide opportunities for recreation space, trails, plant nurseries, access roads, gateways, artwork, and other community amenities. Utilizing infrastructure rights-of-way is critical to creating a connected system of trails and open space across LA County.

Three utility agencies, the City of Los Angeles Department of Water and Power (LADWP), Southern California Edison, and the City of Vernon Gas and Electric Department, maintain power lines and transmission towers located on the service road or adjacent to the channel. Project teams working in areas near a transmission line should contact the utility companies directly to confirm current requirements. These agencies will separately check and approve projects and planting plans within their easements.

## RAIL RIGHTS-OF-WAY

Some LA River projects will be located adjacent to not-in-service railroad rights-of-way. These rights-of-way are opportunities for increased connectivity to the trails and paths around LA County. Project teams working near rail rights-of-way should contact the right-of-way owner to discuss opportunities and requirements.



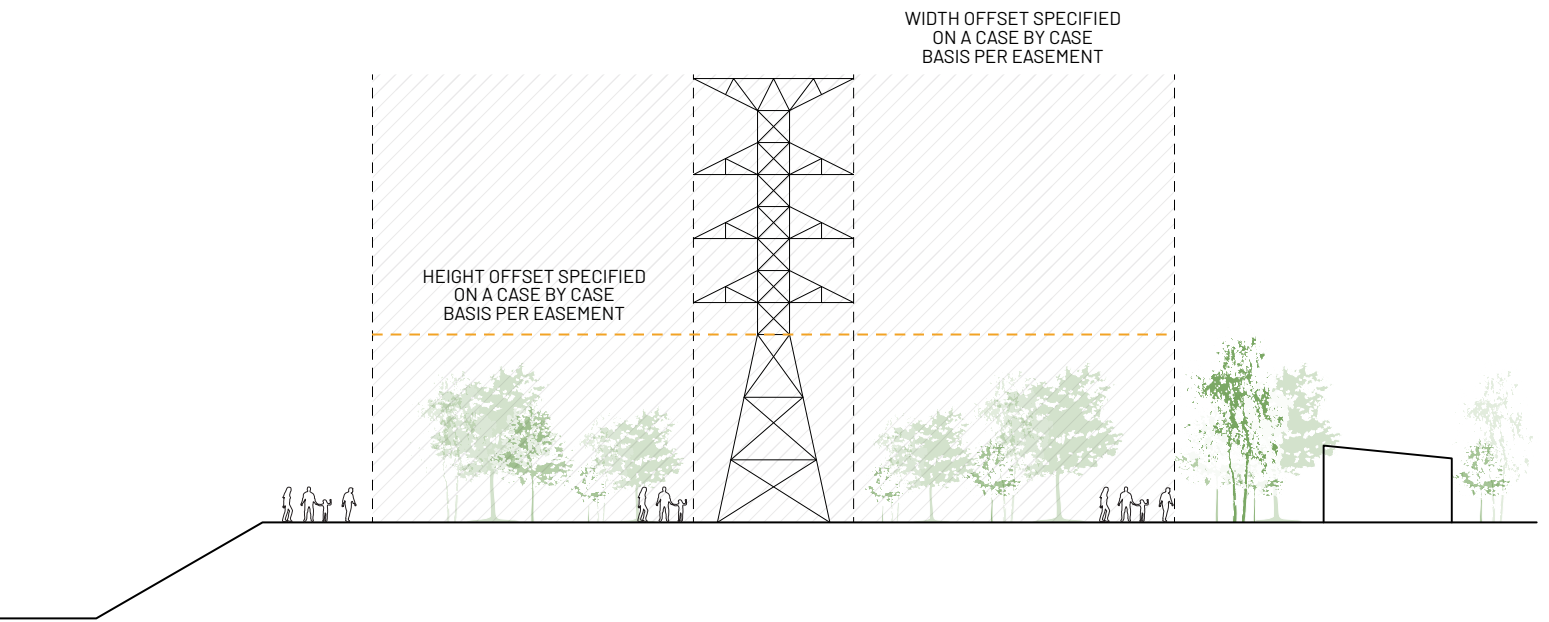
### UTILITY ROW PLANTING

Figure 131. Requirements for planting in a utility ROW vary depending on the specific utility agency, but often include limitations on the installation of vegetation of a certain height or within a specified distance to the utility's infrastructure.



PROJECT TEAMS WORKING IN AREAS NEAR  
A TRANSMISSION LINE SHOULD CONTACT  
THE UTILITY COMPANIES DIRECTLY TO  
CONFIRM CURRENT REQUIREMENTS

---



## **SAFETY BEST PRACTICES ALONG THE RIVER**

Safety along the LA River is of utmost importance to all users of the river corridor, during both regular recreational use and periodic flood events. Designers can incorporate clear lines of sight and allow clearance for emergency vehicles to promote safety in river projects.

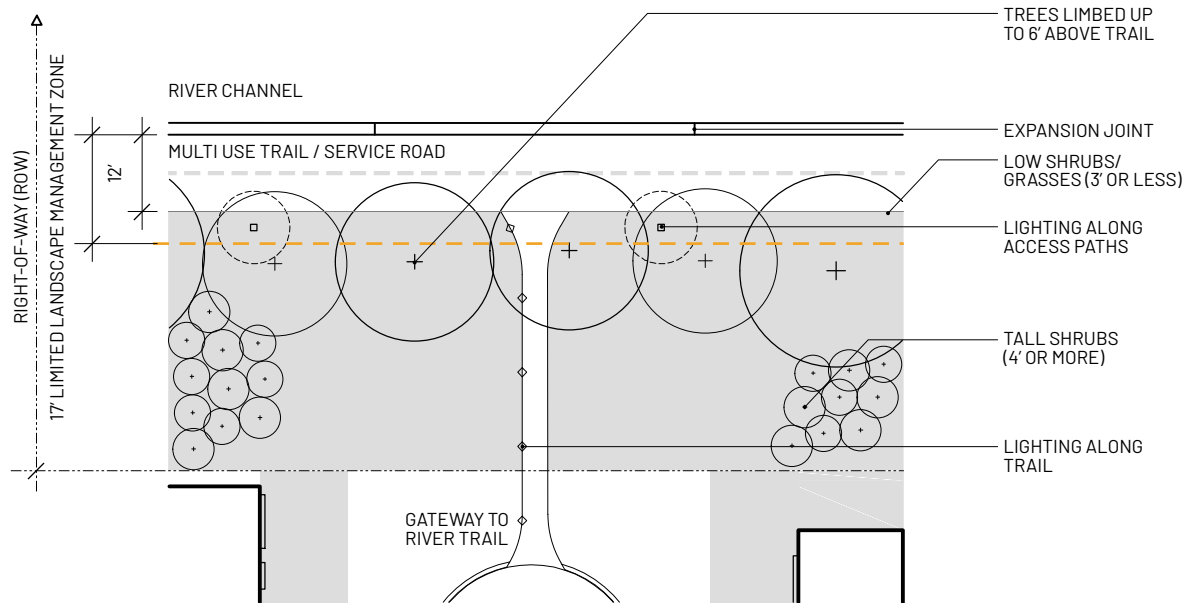
From a planting design perspective, planting densities need to consider the safety of pedestrians, joggers, and cyclists along all trails by providing sufficient line-of-sight clearance. Clear lines of sight are especially important at access points and trail intersections, where planting should be kept below 3 feet in height, and trees should be limbed up at least 6 feet (Figure 130).

Further, lighting should be spaced at regular intervals along the river trail to maintain a consistent level of visibility in the evenings. Trees should be placed so as not to shield the light sources along the trails. For further information on lighting, see Chapter 6.

Maintaining the 17-foot Limited Landscape Management Zone allows for emergency vehicles to access the channel when necessary. In-channel rescues during flood conditions are performed by city and county fire departments. Rescue anchors located adjacent to major arterials throughout LA County are embedded into the concrete panels along both sides of the river for use in emergency situations.

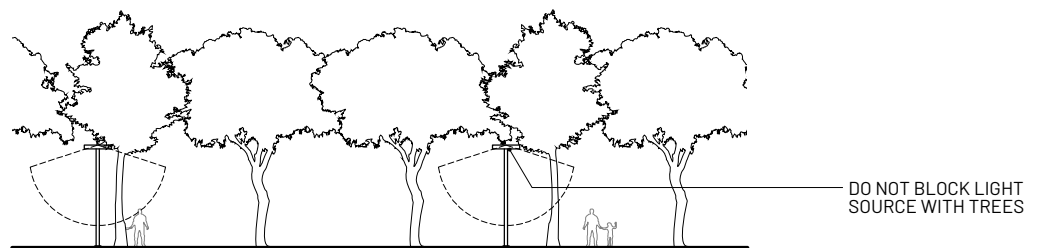
County Flood Control District Maintenance Standards for both maintenance and emergency vehicle ingress and egress apply in current and future locations. Designers should take the swift water anchor rescue locations into account when planning projects.

**MAINTAINING A CLEAR LINE OF SIGHT BETWEEN 3-6 FEET IN HEIGHT IS ESPECIALLY IMPORTANT AT RIVER ACCESS POINTS AND TRAIL INTERSECTIONS**



**VISIBILITY AT ACCESS POINTS**

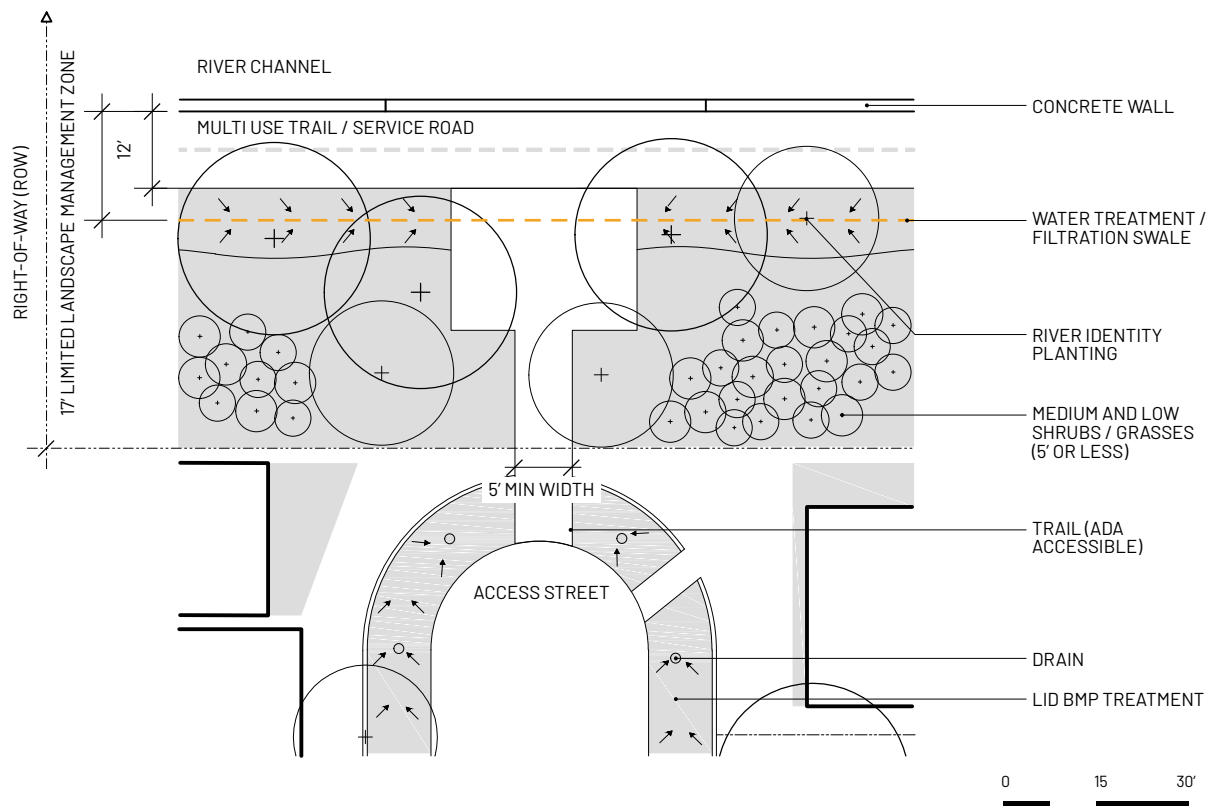
Figure 132. Clear lines of sight and consistently lit paths of travel should be included at gateways and access points.



**LIGHTING ALONG THE TRAIL**

Figure 133. Lighting along the LA River trail should be consistent and should not be blocked by tree limbs or any other obstructions.





### STREET ACCESS PLAN

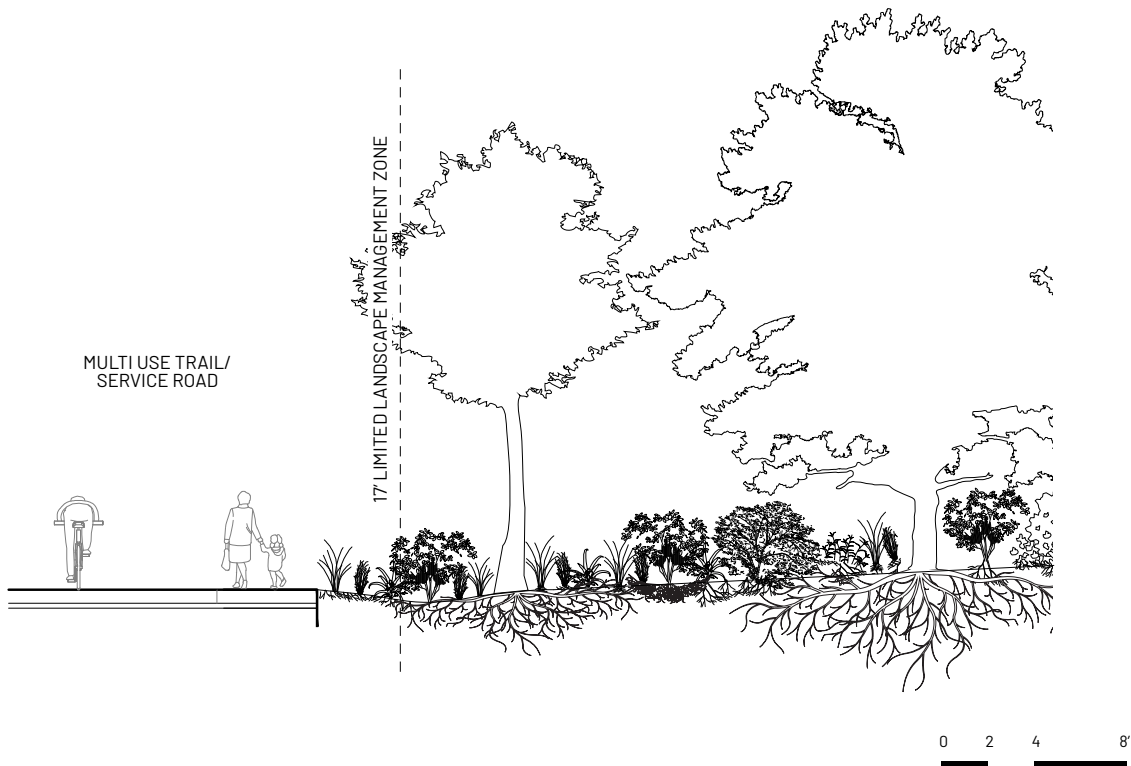
Figure 134. Access points where a street drains into the river provide opportunities to capture and treat stormwater. Swales along trails that slope away from the river also provide opportunities for water treatment.

## PLANTED BUFFERS

Planted buffers along the LA River corridor provide comfort for pedestrians along the river trail, promote the unique sense of place of the river, and provide an opportunity for the treatment of stormwater before it enters the river.

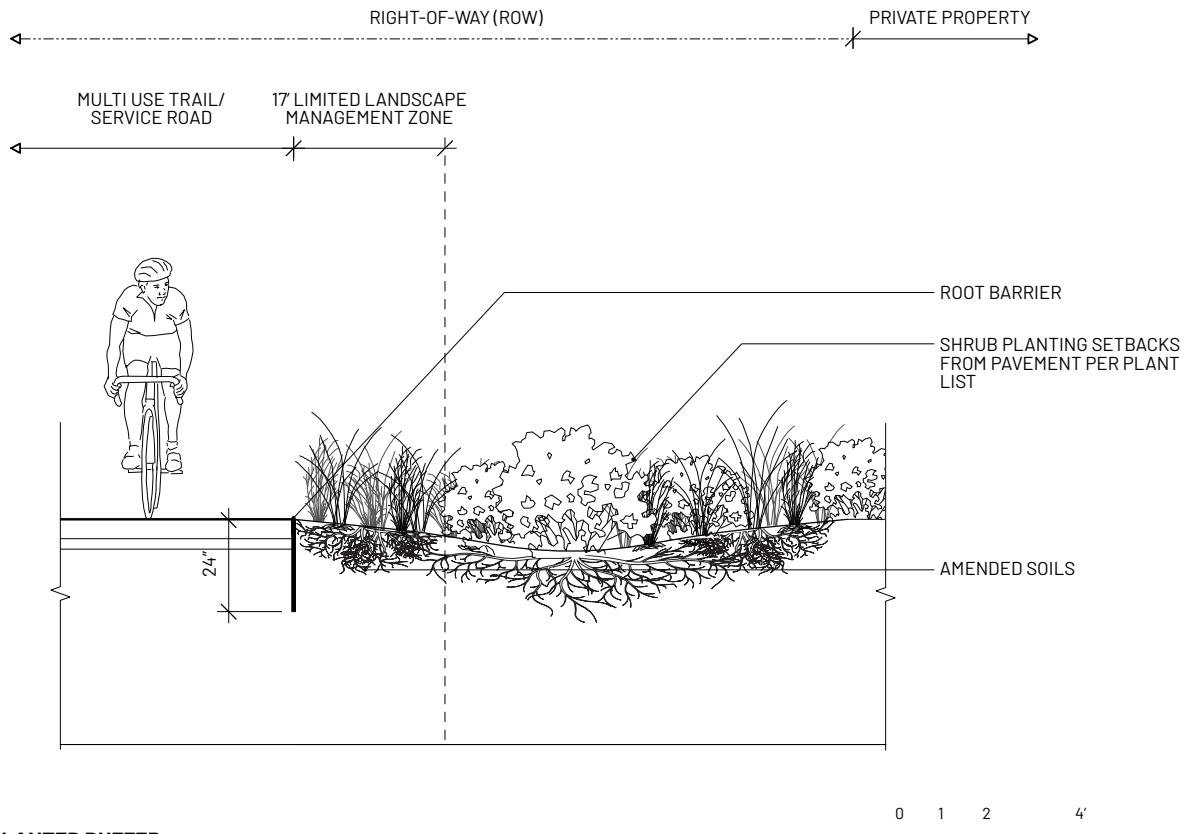
Where a neighborhood street drains directly into the river, new projects should aim to create bioswales or treatment basins to collect stormwater runoff. Further, new trails, especially those that are paved with impervious materials, should slope to drain away from the river channel towards a bioswale or other BMP area.

Planted buffers should also adhere to suggested setbacks from pavement found in the plants lists at the end of this chapter. Trees and shrubs above 5 feet tall should be set back a minimum of 5 feet from the edge of the pavement. This setback distance can be halved if a 24-inch root barrier is installed immediately next to the pavement, and if the limited landscape management zone clearance is met.



**WIDE PLANTED BUFFER**

Figure 135. A densely planted buffer consisting of trees, shrubs, and groundcovers creates a unique sense of place along the LA River and provides opportunities to create connected habitats.



**NARROW PLANTED BUFFER**

Figure 136. If a trail is designed to slope towards a planted swale, it can collect, convey, and treat stormwater before it reaches the LA River.

FOR MORE IN-DEPTH INFORMATION  
ON STORMWATER BEST MANAGEMENT  
PRACTICES, PLEASE REFERENCE THE  
LA COUNTY PUBLIC WORKS LOW IMPACT  
DEVELOPMENT STANDARDS MANUAL

---

## STORMWATER BEST MANAGEMENT PRACTICES

Stormwater best management practices (BMPs) help capture, convey, and treat stormwater through infiltration or other mechanisms during a rain event. The integration of vegetation to enhance BMPs is encouraged and yields benefits to carbon sequestration and reduced urban heat generation. Some of the most commonly implemented BMPs include rain gardens, swales, infiltration strips, and infiltration trenches. It is important to work with engineers to ensure that the soils in the project sites are suitable for infiltration. Overall these methods are most effective during common rain events, since during higher, less frequent flood events these methods usually become saturated to capacity.

Rain gardens and swales require more space to implement, while infiltration strips and trenches are ideal for tight spaces or areas adjacent to structures. Along the LA River, rain gardens can be implemented where there is a wider project site. These project sites are to be studied to identify optimal locations and possible grading actions that will increase the capture and retention of rainfall to help sustain the growth of the native plantings. Swales can often be installed along paved trails or other linear projects. Swales convey water at a slower rate than traditional pipes do, and it is important to work with an engineer to make sure that the designed swale works with the overall stormwater approach for the project. Infiltration strips and trenches work best where there is a narrow right-of-way, or alongside structures or river pavilions (see Chapter 6). Infiltration can be further enhanced by the installation of vertical perforated pipes within

the dripline of larger shrubs and tree species, installed at the time of planting. However, adequate drainage and possible bypass of the planting area is necessary for heavier storms or obstructed systems. Typical drawdown time requirements for infiltration systems is between 72-96 hours, as dictated by vector control regulations to reduce mosquito populations.

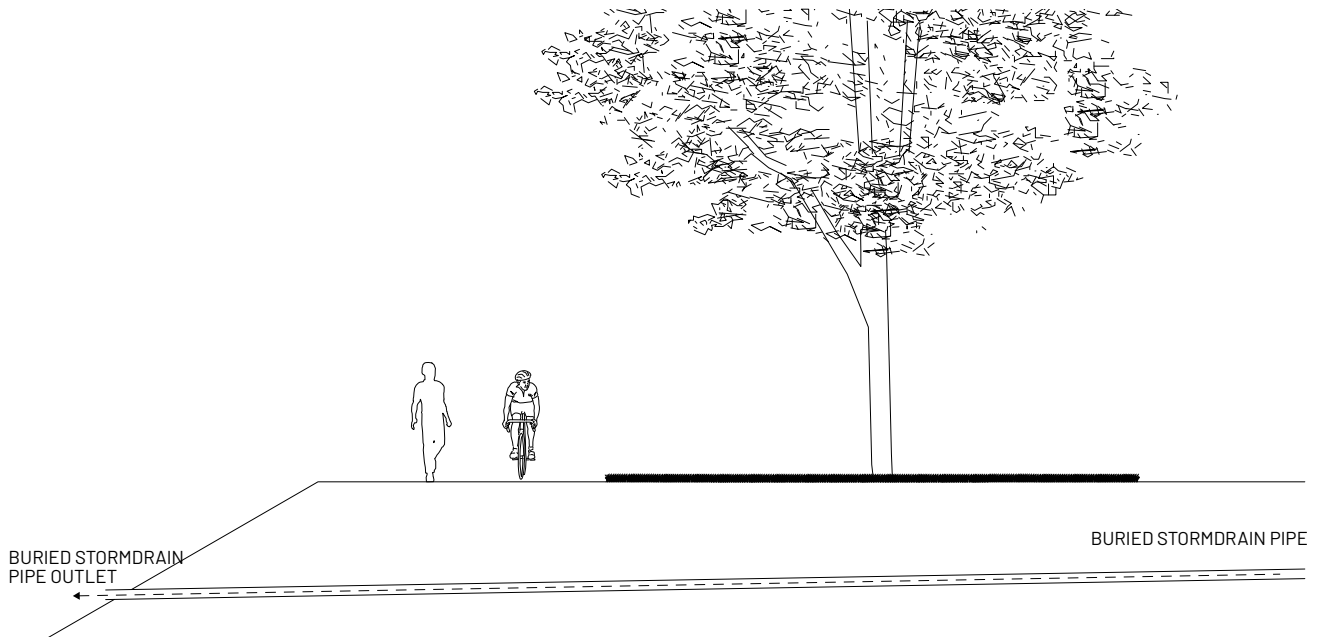
The daylighting of existing storm drains is another method for installing BMPs, as shown in Figure 138. Daylit storm drains can be gravity fed and would help increase the treatment and re-use of stormwater in the right-of-way before it enters the river channel. All BMPs require continued maintenance for long-term success, otherwise they risk becoming obstructed with debris and rendered ineffective.

The following items are important to facilitate long-term success of BMPs:

- Long-term commitment to regular maintenance of BMPs; vegetated BMPs in particular are prone to accelerated failures without regular maintenance
- Proper sizing of BMPs with respect to tributary drainage areas
- Adding/requiring pre-treatment BMPs to remove gross solids, sediments, trash, and debris is critical and recommended for BMPs

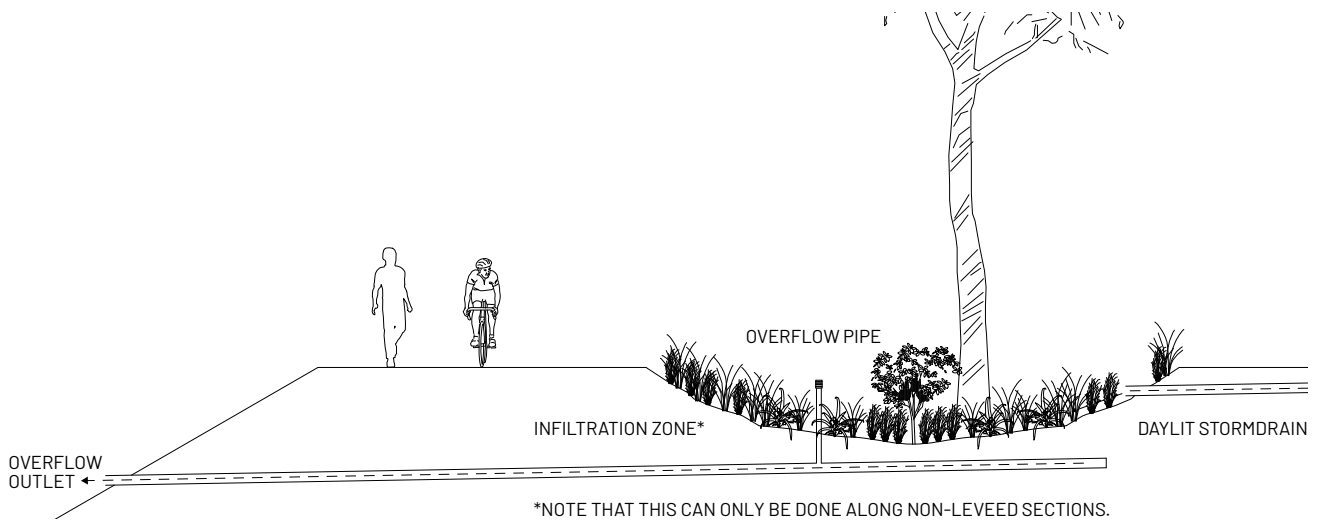
For more in-depth information on BMPs, please reference the LA County Public Works Low Impact Development Standards Manual.<sup>21</sup>





**PIPED DRAINAGE CONDITION**

Figure 137. New projects along the LA River offer the opportunity to change the typical condition of stormdrain pipes that flow underneath street ends and exit directly into the river channel.



\*NOTE THAT THIS CAN ONLY BE DONE ALONG NON-LEVEED SECTIONS.

**DAYLIT DRAINAGE CONDITION**

Figure 138. A daylit storm drain allows for infiltration and treatment of runoff before it enters the LA River. These types of projects can help improve the water quality in the river.

## BEST MANAGEMENT PRACTICE TECHNIQUES

## PROS AND CONS

### STORMWATER PLANTER



#### PROS:

- Requires little space
- Reduces peak flows during small storm events
- Enhances site aesthetics
- May conserve water

#### CONS:

- May require additional irrigation
- Not suitable for areas with steep slopes

### TREE WELL FILTER



#### PROS:

- Enhances site aesthetics
- Reduces stormwater runoff volume and pollutant discharge
- Ideal for highly-developed sites
- Integrates well with linear landscapes

#### CONS:

- May require additional irrigation

### VEGETATED SWALES



#### PROS:

- Low cost of installation
- Reduces peak flows during small storm events

#### CONS:

- Has limited water quality benefits beyond gross solids filtration
- Not suitable for areas with steep slopes
- Can cause erosion when not installed and maintained properly

### VEGETATED FILTER STRIP



#### PROS:

- Easy to install
- Reduces peak flows during small storm events
- Enhances site aesthetics

#### CONS:

- Not suitable for areas with steep slopes
- Can cause erosion when not installed and maintained properly

Figure 139. Various BMP techniques can be implemented depending on the space available and intended use. Source: (Top) OLIN, 2018, (Middle) OLIN, 2018, (Bottom) Roger Soh, 2010.

## SECTION

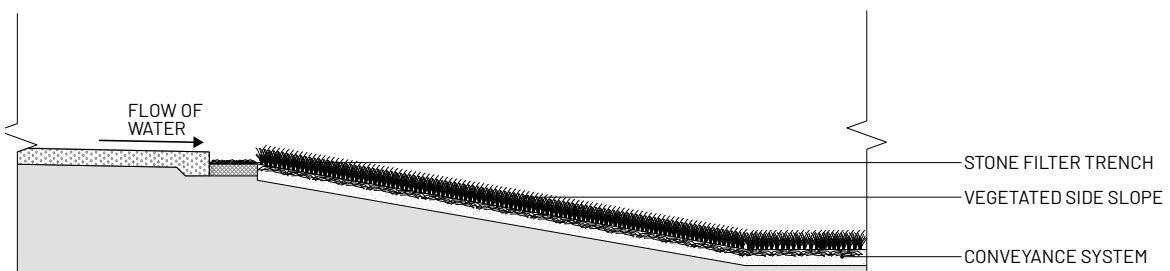
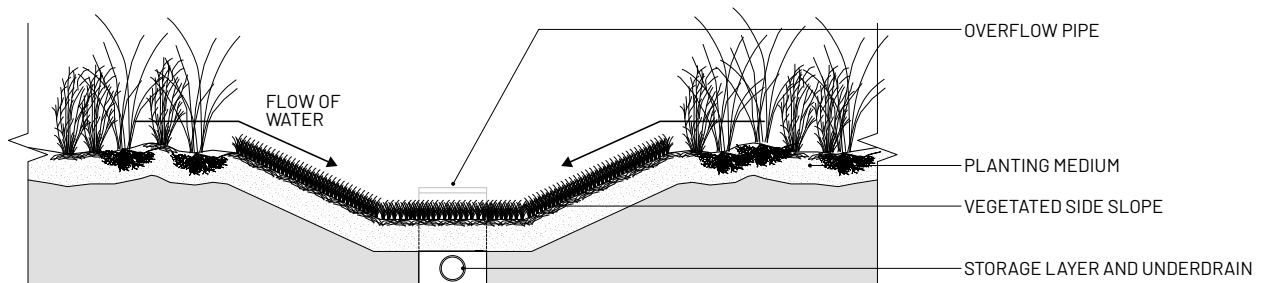
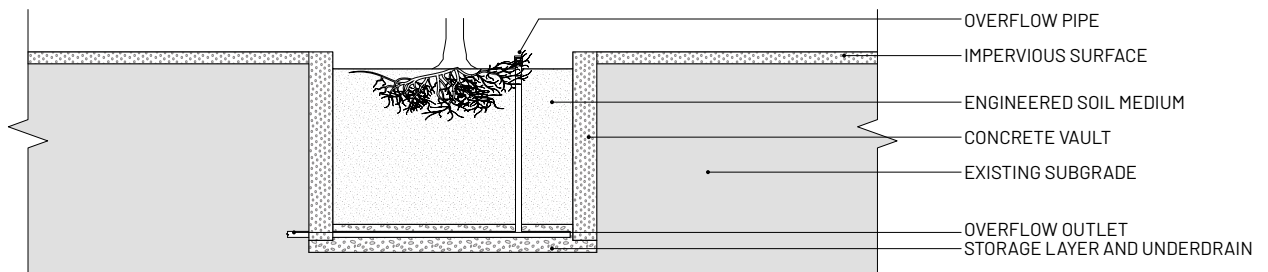
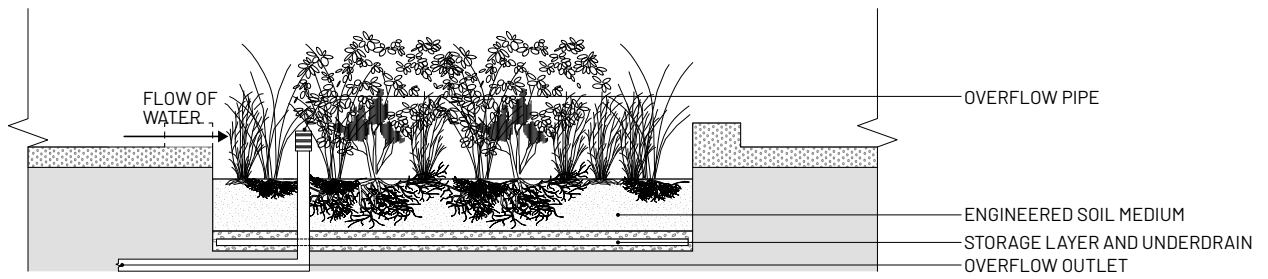
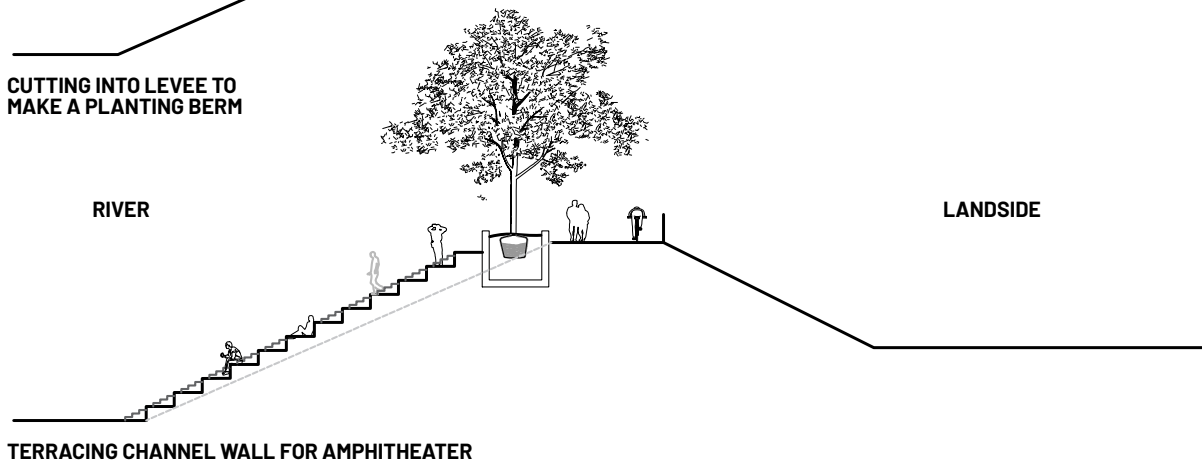
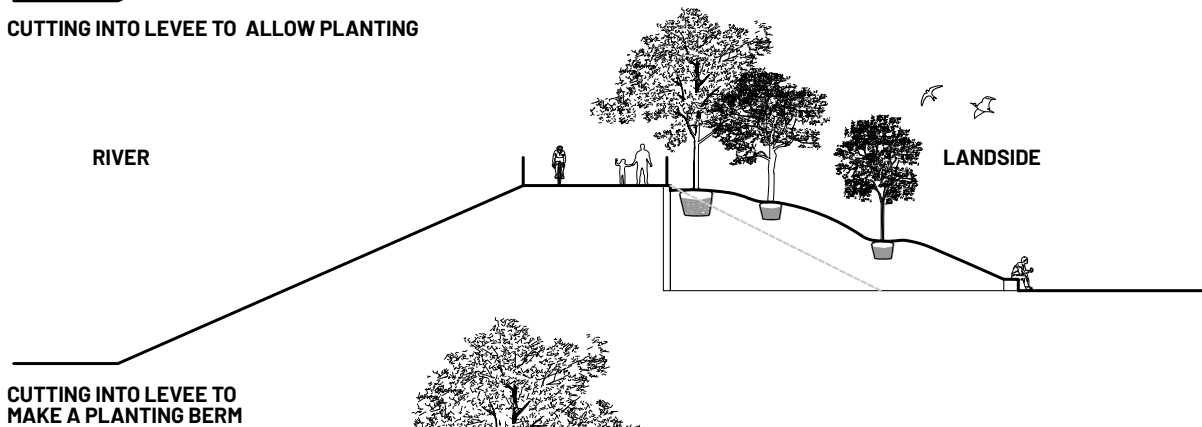
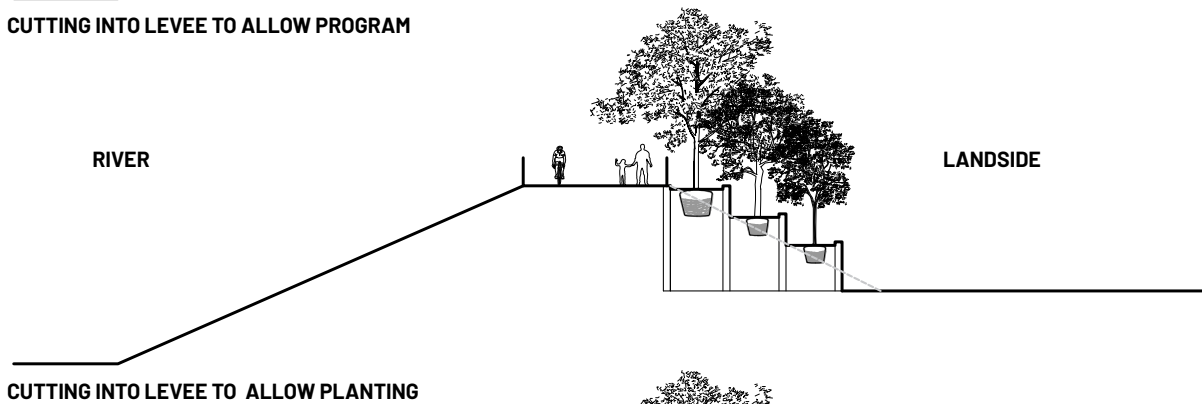
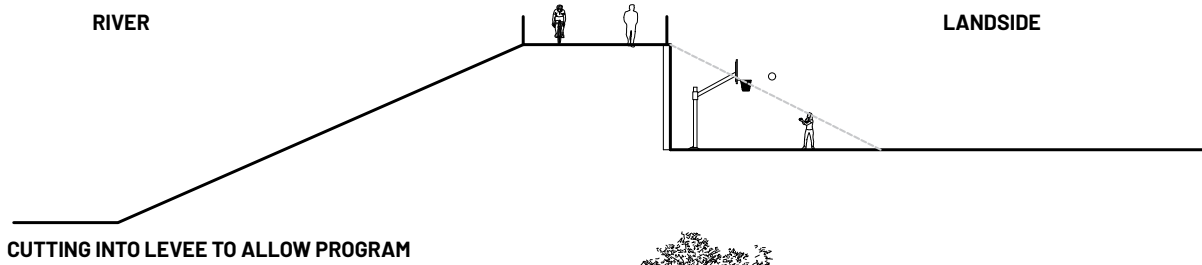
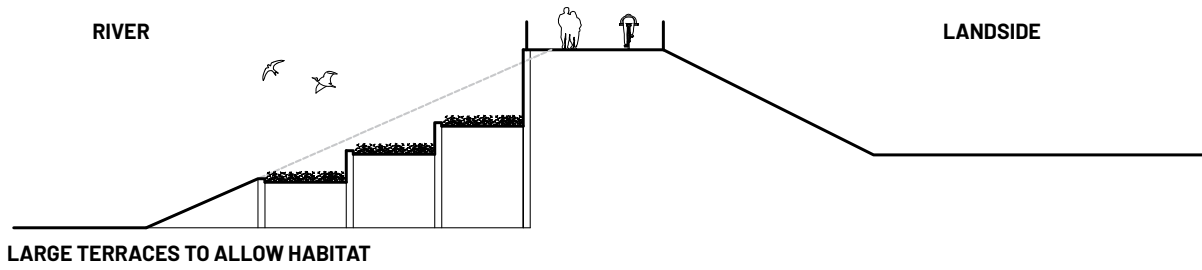


Figure 140. The infrastructure of each BMP varies based on project needs and should be designed with engineers.



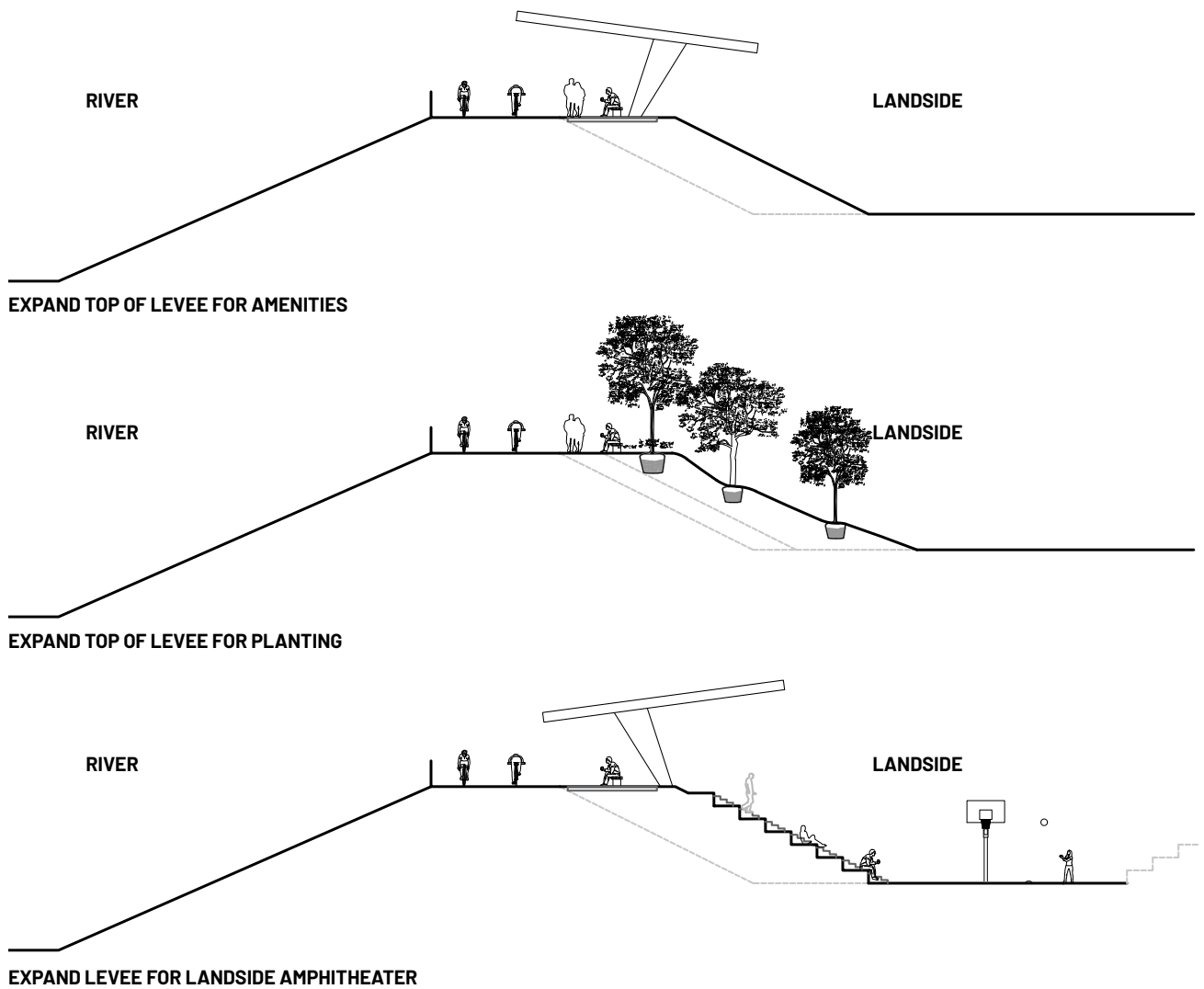


Figure 141. Ideas on variations of channel modifications help push the envelope of what is possible along the LA River. Hydraulic analysis and coordination with engineers is necessary to bring these ideas to fruition.

## CHANNEL MODIFICATIONS: INNOVATION

Designers are encouraged to create innovative designs for integrating ecological function and programming into the channel edge conditions. All changes are subject to permit requirements. Proposed modifications should encourage accessibility for all.

Design guidelines represent potential configurations based on general hydraulic considerations. Additional site-specific analyses, such as 2-D or 3-D numerical modeling and/or physical modeling, may be required to demonstrate hydraulic feasibility in terms of not reducing channel capacity, not significantly raising the design watersurface elevation, and minimizing and containing standing waves. These modifications are not a solution for all 51 miles of the LA River.

CHANNEL MODIFICATIONS SHOULD NOT INCREASE FLOOD RISK AND SHOULD BE UNDERTAKEN WITH A HIGHLY SKILLED DESIGN TEAM, INCLUDING QUALIFIED ENGINEERS AND LANDSCAPE ARCHITECTS

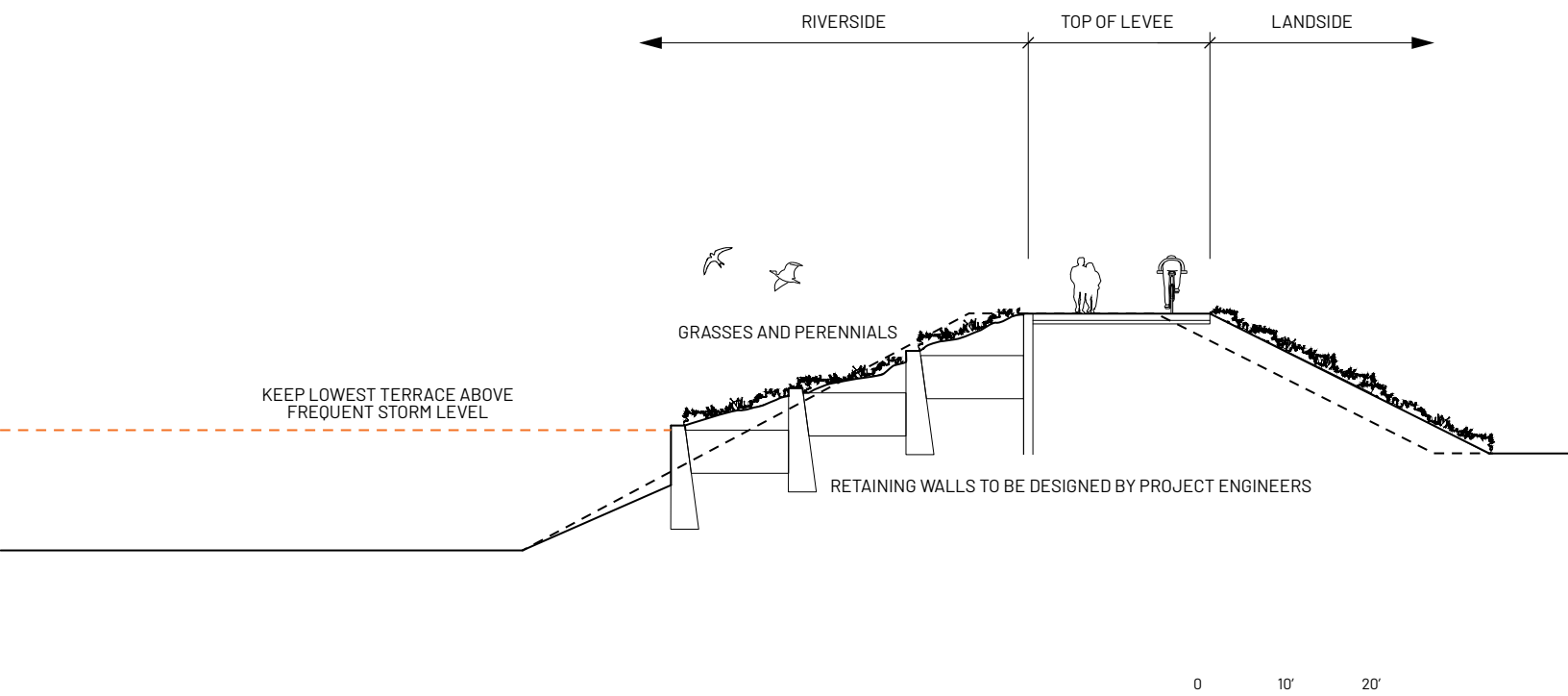
---

## CHANNEL MODIFICATIONS: TRAPEZOIDAL CHANNEL

Any modification to an existing channel wall along the LA River is a significant project and investment. This should not be undertaken without qualified engineers who can evaluate the hydraulic and flood risk impacts of any proposed intervention. At a minimum, proposed modifications should not lower the level of flood risk reduction provided before the start of the project. These modifications are not a solution for all 51 miles of the LA River.

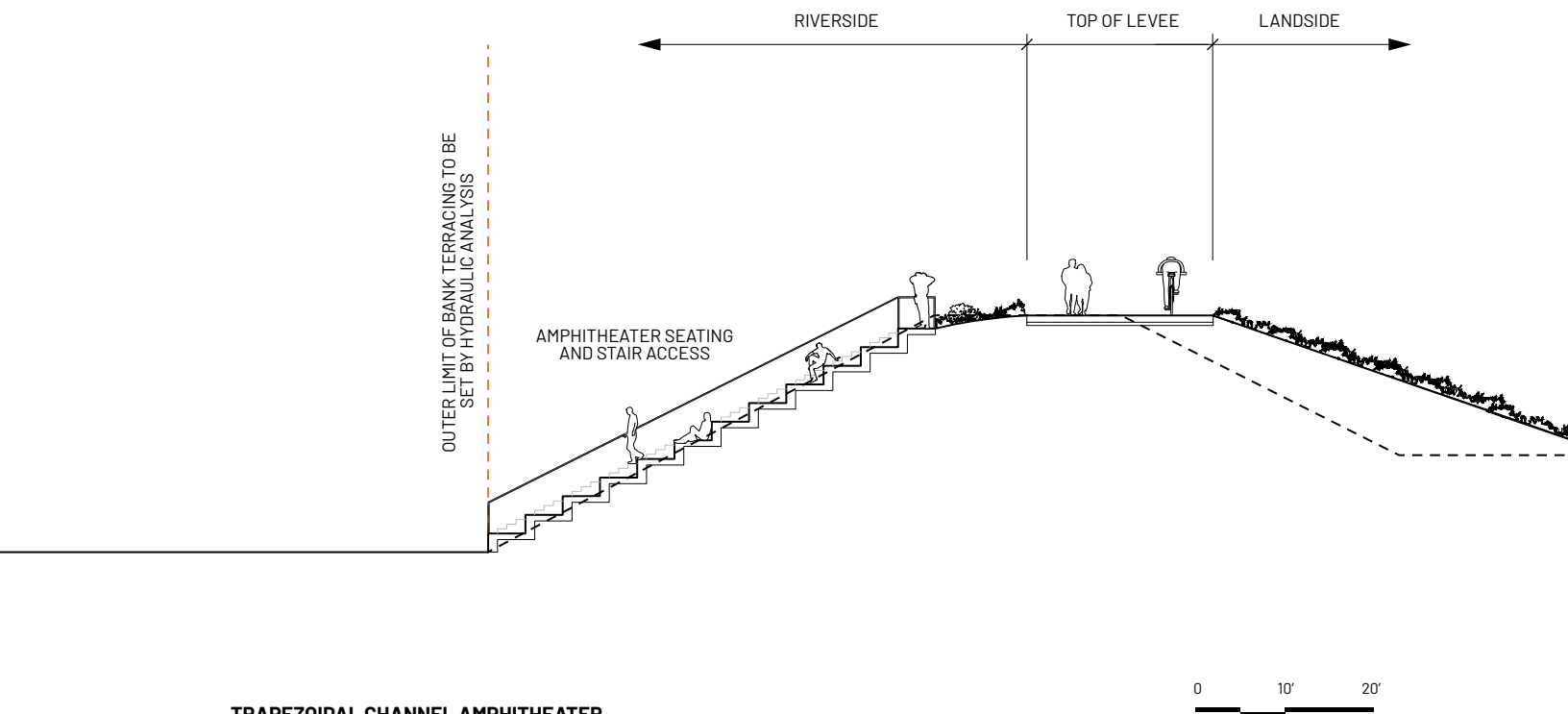
Given these parameters, there are two ways to consider terracing a trapezoidal channel where possible. The first method includes wide stepped terraces for planting. Wider planting beds help to retain soil moisture in the heat of summer. Still, additional irrigation and diligent maintenance will be required to ensure the health of the plants. Further, the lowest terrace should be elevated above a frequent storm level to prevent planting from being scoured or eroded during common rain events. In the case of a larger, less frequent flood event, the planting and soil in the terraces may still need to be replenished due to scouring and erosion. The second method of terracing would create hardscape steps and amphitheater seating along the trapezoidal wall. This terracing could be used by the public for special events or festivals that could occur in the channel with appropriate permission and outside of the flood season. While erosion would not be an issue with this method, the amphitheater and steps should still be inspected for cracks or other damage after a major flood event.





**TRAPEZOIDAL CHANNEL PLANTING**

Figure 142. The trapezoidal channel could be modified to create large terraces for habitat. Consultation with qualified engineers and hydraulic analysis is necessary. This is not a solution for all 51 miles of the LA River.



**TRAPEZOIDAL CHANNEL AMPHITHEATER**

Figure 143. The trapezoidal channel could be modified to create a public amphitheater. Consultation with qualified engineers and hydraulic analysis is necessary. This is not a solution for all 51 miles of the LA River.

CHANNEL MODIFICATIONS SHOULD NOT INCREASE FLOOD RISK, AND SHOULD BE UNDERTAKEN WITH A HIGHLY SKILLED DESIGN TEAM, INCLUDING QUALIFIED ENGINEERS AND LANDSCAPE ARCHITECTS

## CHANNEL MODIFICATIONS: RECTANGULAR CHANNEL

Any modification to an existing channel wall along the LA River is a significant project and investment. This should not be undertaken without qualified engineers who can evaluate the hydraulic and flood risk impacts of any proposed intervention. At a minimum, proposed modifications should not lower the level of flood risk reduction provided before the start of the project. These modifications are not a solution for all 51 miles of the LA River.

Methods to potentially modify the box channel are shown in the sections to the right and plans below. One method involves creating a larger terrace for planting, and potentially for stormwater capture and treatment before being released back into the LA River. The terrace should be elevated above the design storm events to prevent scour. The other method opens the wall of the rectangular section to allow for a ramp to enter the channel. The ramps will be used by maintenance vehicles but also can be widened and joined with a large public amphitheater or a vegetated slope. The vegetated slope allows for riparian-upland connection, so that wildlife can access the river as well.

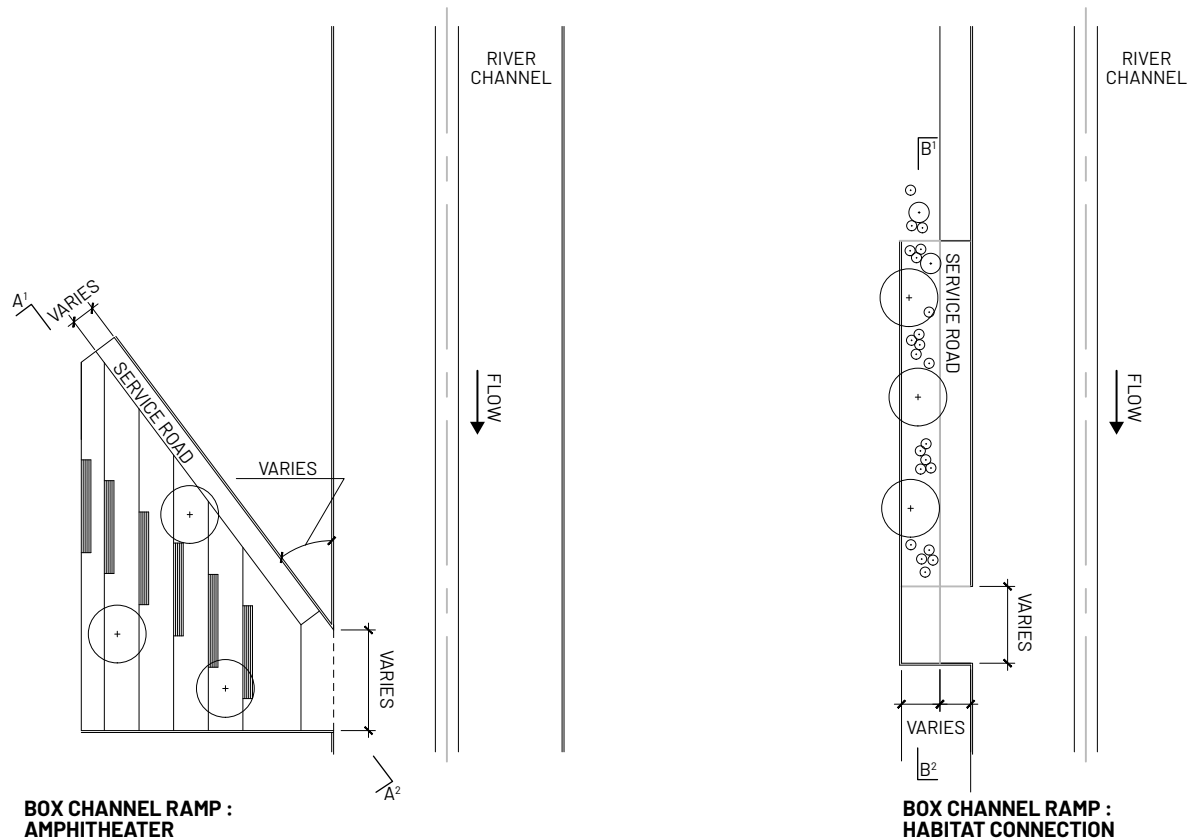
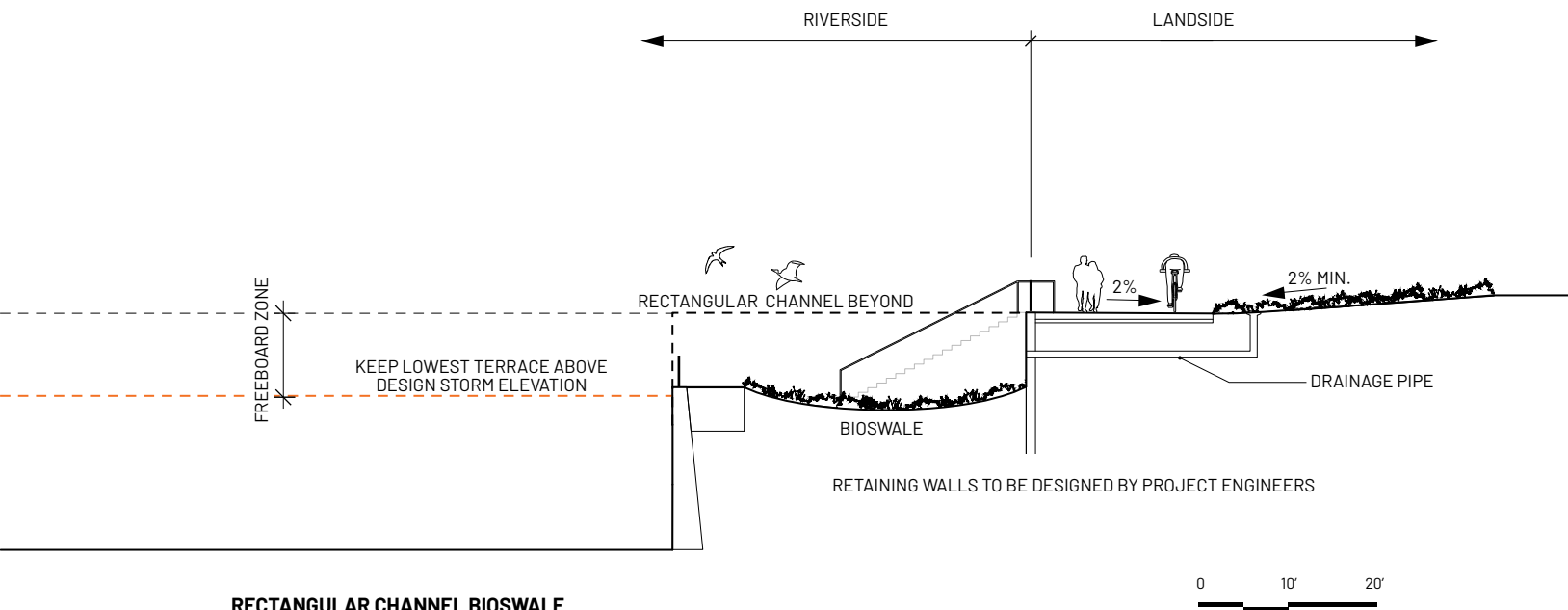
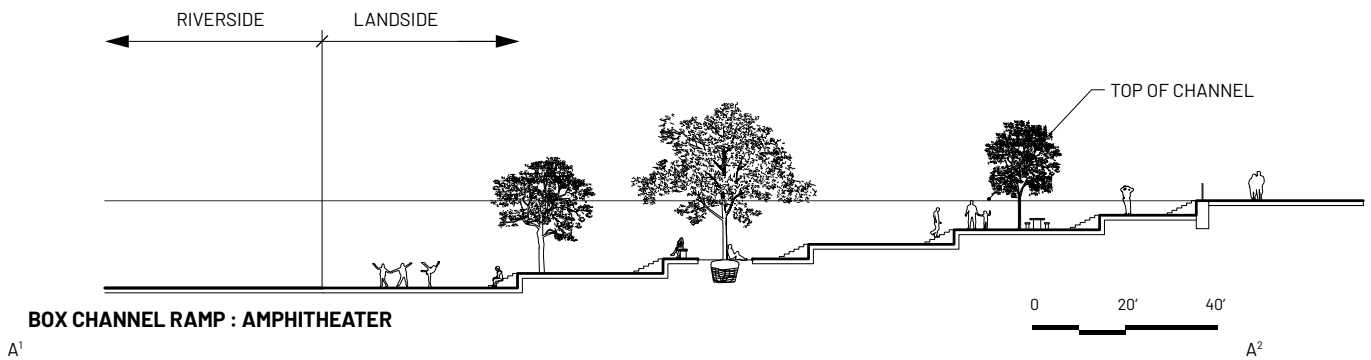


Figure 144. The rectangular channel could be modified to create large amphitheatres, a performance venue, or ramps for wildlife. Consultation with qualified engineers and hydraulic analysis is necessary. For sections of these conditions, See Figure 146 on page 187.

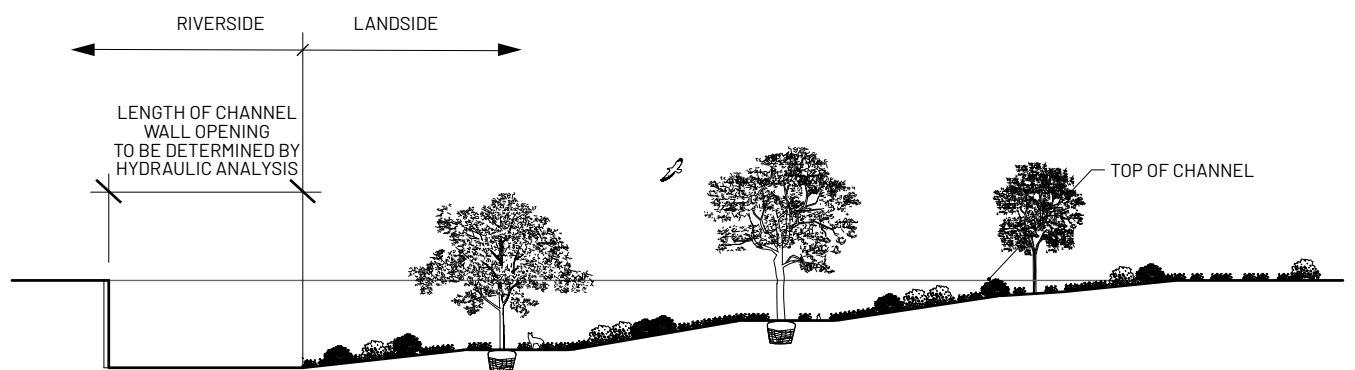


**RECTANGULAR CHANNEL BIOSWALE**

Figure 145. The rectangular channel could be modified to create a bioswale to collect and treat water before it enters the LA River. Consultation with qualified engineers and hydraulic analysis is necessary. This is not a solution for all 51 miles of the LA River.

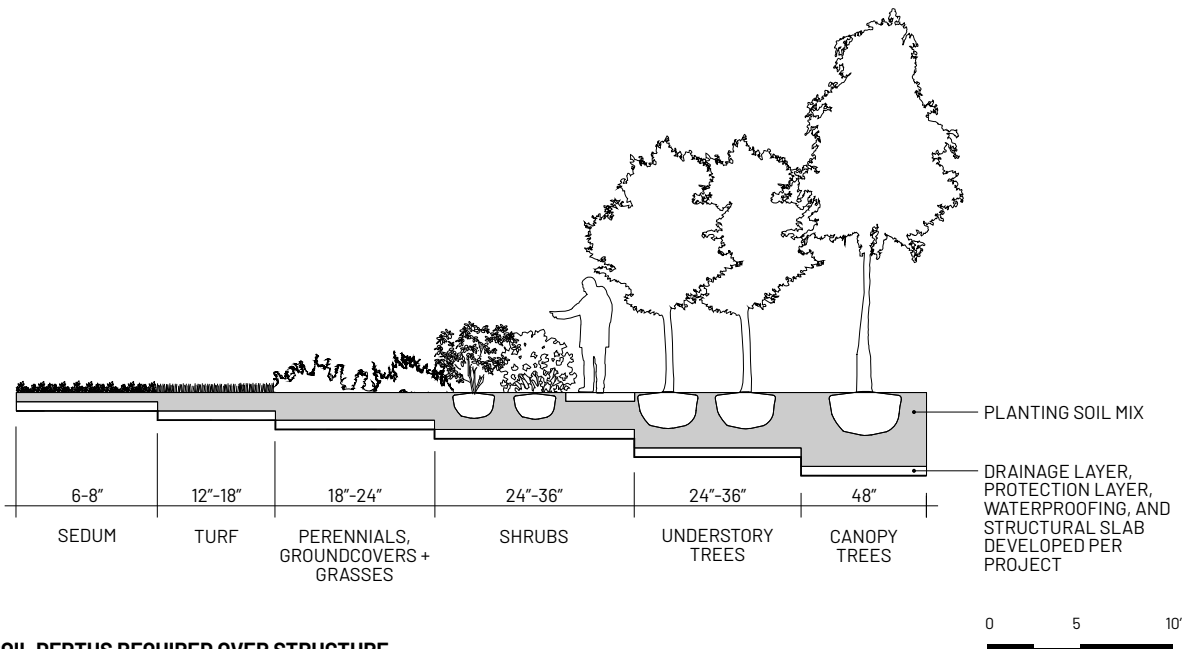


**BOX CHANNEL RAMP : AMPHITHEATER**



**BOX CHANNEL RAMP : HABITAT CONNECTION**

Figure 146. The rectangular channel could be modified to create large amphitheatres, a performance venue, or ramps for wildlife. Consultation with qualified engineers and hydraulic analysis is necessary.



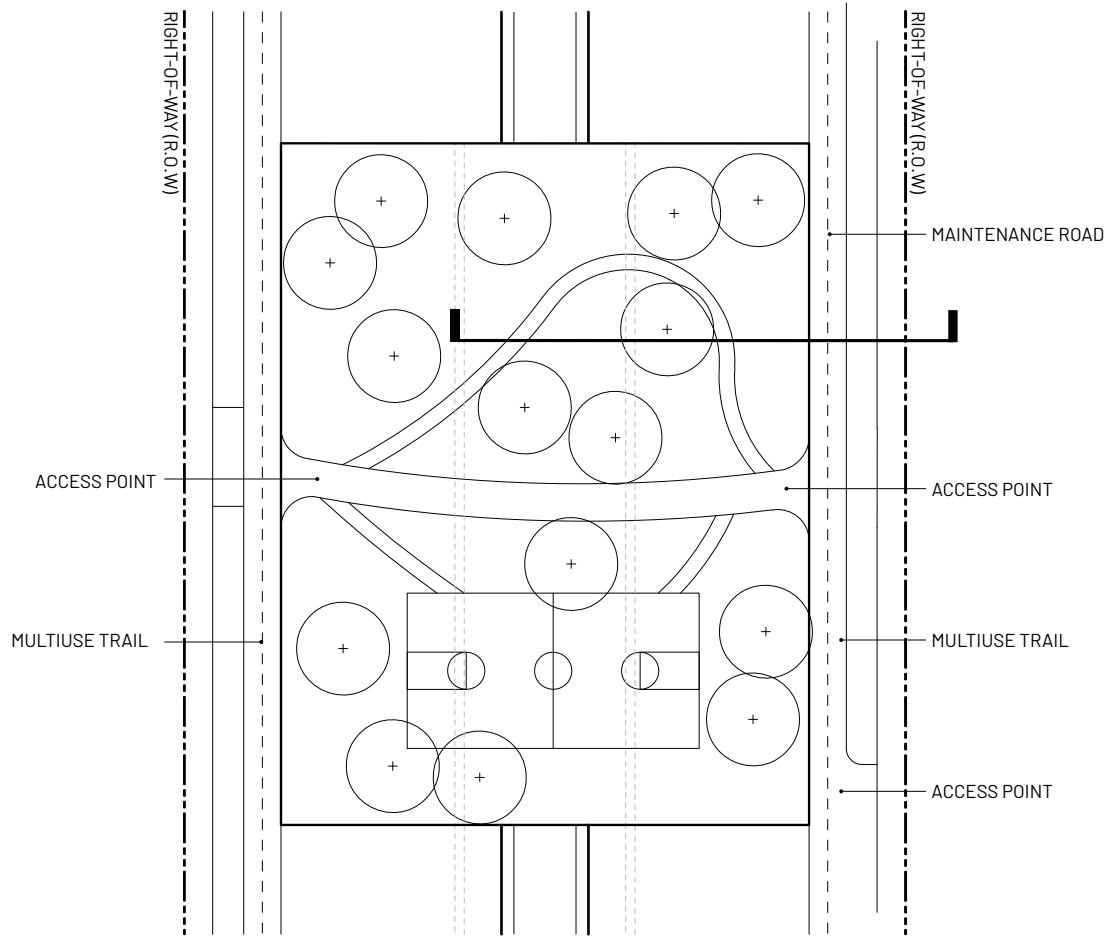
### SOIL DEPTHS REQUIRED OVER STRUCTURE

Figure 147. To ensure the healthy growth of planting, the following soil depths should be implemented over structure. The required depths, drainage, and waterproofing need to be coordinated across the project team.

## PLATFORM PARKS

Platforms create a land bridge across the river channel. This modification is a major project and investment and should not be undertaken without both hydraulic and structural engineering. The platform strategy is most effective when there is a high need for connectivity or park space and there is limited or nonexistent landside right-of-way. The platform takes advantage of the right-of-way within the corridor itself to create an engaging public space and destination. Planting on the platform should be considered as a landscape over structure and adequate soil depths should be provided, as shown in Figure 50. Waterproofing and root barriers on the platform should be developed on a per project basis across the project team, and is crucial for ensuring proper drainage and structural integrity of the platform. This solution cannot be used over soft bottom portions of the channel or in the estuary. Platforms cannot be used for development - only open space, and service trucks will need to have access underneath. Other design considerations include providing for guardrails, ADA access to the platform park, vertical clearance for maintenance vehicles, and the potential for artwork. Overall, the platform park should be welcoming, well-maintained, and programmed so as to serve the needs of the adjacent community.

UPSTREAM OFFSET OR CONNECTION TO EXISTING BRIDGE STRUCTURE  
TO BE DETERMINED BASED ON HYDRAULIC ANALYSES

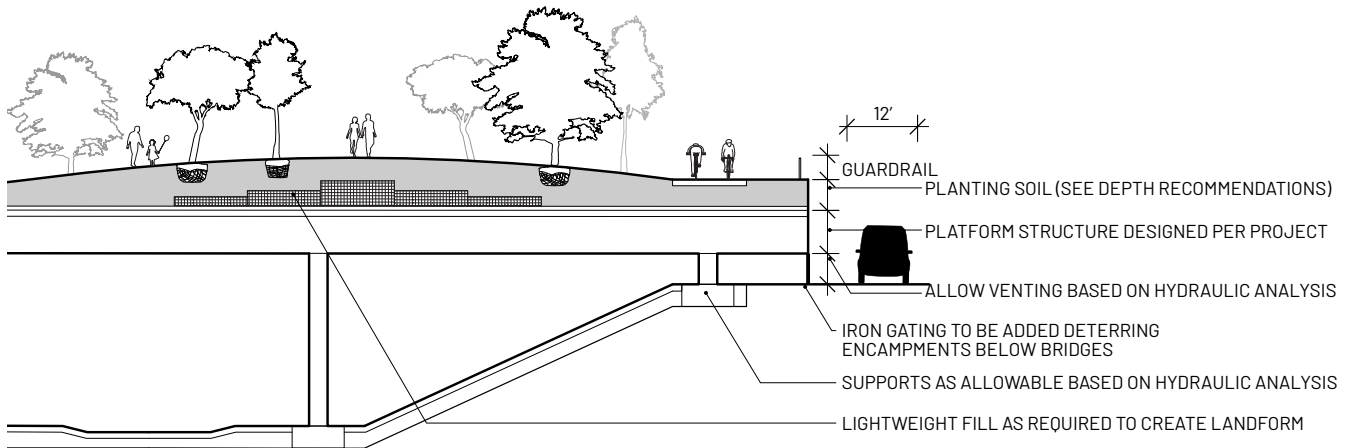


DOWNSTREAM OFFSET OR CONNECTION TO EXISTING BRIDGE STRUCTURE  
TO BE DETERMINED BASED ON HYDRAULIC ANALYSES

**PLATFORM CROSSING AND PARKWAY PLAN**



Figure 148. Platform program and design may vary to include a range of ecological functions, recreational amenities, or passive park space. Platforms cannot be used over soft bottom portions of the channel or in the estuary. Platforms cannot be used for development, only for open space. This is not a solution for all 51 miles of the LA River.



**PLATFORM CROSSING AND PARKWAY SECTION**

Figure 149. Platform construction is complex and should be designed per project by the design team. Service trucks will need to have access underneath the platform. Consultation with qualified engineers and hydraulic analysis is necessary. This is not a solution for all 51 miles of the LA River.

## PRODUCTIVE LANDSCAPES

Urban agriculture and other forms of productive landscapes should be encouraged in sites along the LA River, especially in communities with limited access to fresh food sources.

For continued success, urban agriculture projects should have strong ties to the community and community organizations that can conduct programming with the project itself. A continued presence and regularly scheduled events ensures that community members can become engaged stewards of the agricultural plots. Tying the project to programs such as a Community-Supported Agriculture (CSA) can provide fresh produce to community members at a lower cost.

Existing urban agriculture sites around the LA River and other initiatives provide useful precedents for expanding urban agriculture practices along the river corridor. The Urban Agriculture Incentive Zones Act (AB551) enacted by the state of California in 2014 provides incentives to landowners for putting vacant land into agricultural use.<sup>22</sup> The Urban Orchard Project planned by the Trust for Public Land aims to create a community garden and plant culturally significant fruit trees near the Rio Hondo confluence.<sup>23</sup> The Carmelitos Community Garden in Long Beach provides 60 raised beds for families to grow produce and also hosts a variety

of youth programs and community events.<sup>24</sup> Alma Backyard Farms in Compton works with people impacted by the criminal justice system and provides on-site job training services.<sup>25</sup> Farm LA is also a non-profit focused on transforming vacant land in the Elysian Valley to productive land with drought tolerant vegetables such as beans and grains.<sup>26</sup> While these are only a snapshot of existing programs and others to come, the LA River provides an opportunity to expand urban agriculture and host associated urban agriculture events as well as opportunities for artwork.

Siting considerations for any urban agriculture projects include access to full sun and a frequent and consistent water source. Any vegetable plots would ideally be on a level surface such as a flatbed or raised box.

If urban agriculture is to be included in the planting plans of the site, those specific areas do not need to meet native planting requirements. However, under no circumstances are invasive species allowed to be planted. Under the Model Water Efficient Landscape Ordinance adopted in 2015, any areas solely dedicated to edible planting are considered a “Special Landscape Area” and can use higher amounts of water for irrigation than ornamental planting.<sup>27</sup> Only potable water should be used to irrigate edible plants.





**Figure 150.** The creation of urban agricultural and community gardens along the LA River is encouraged and provides opportunities for education, access to fresh food, and a sense of stewardship in landscapes along the river. Productive landscapes are not subject to the same native planting or water requirements as other areas. Source: Craig Dietrich, 2011.

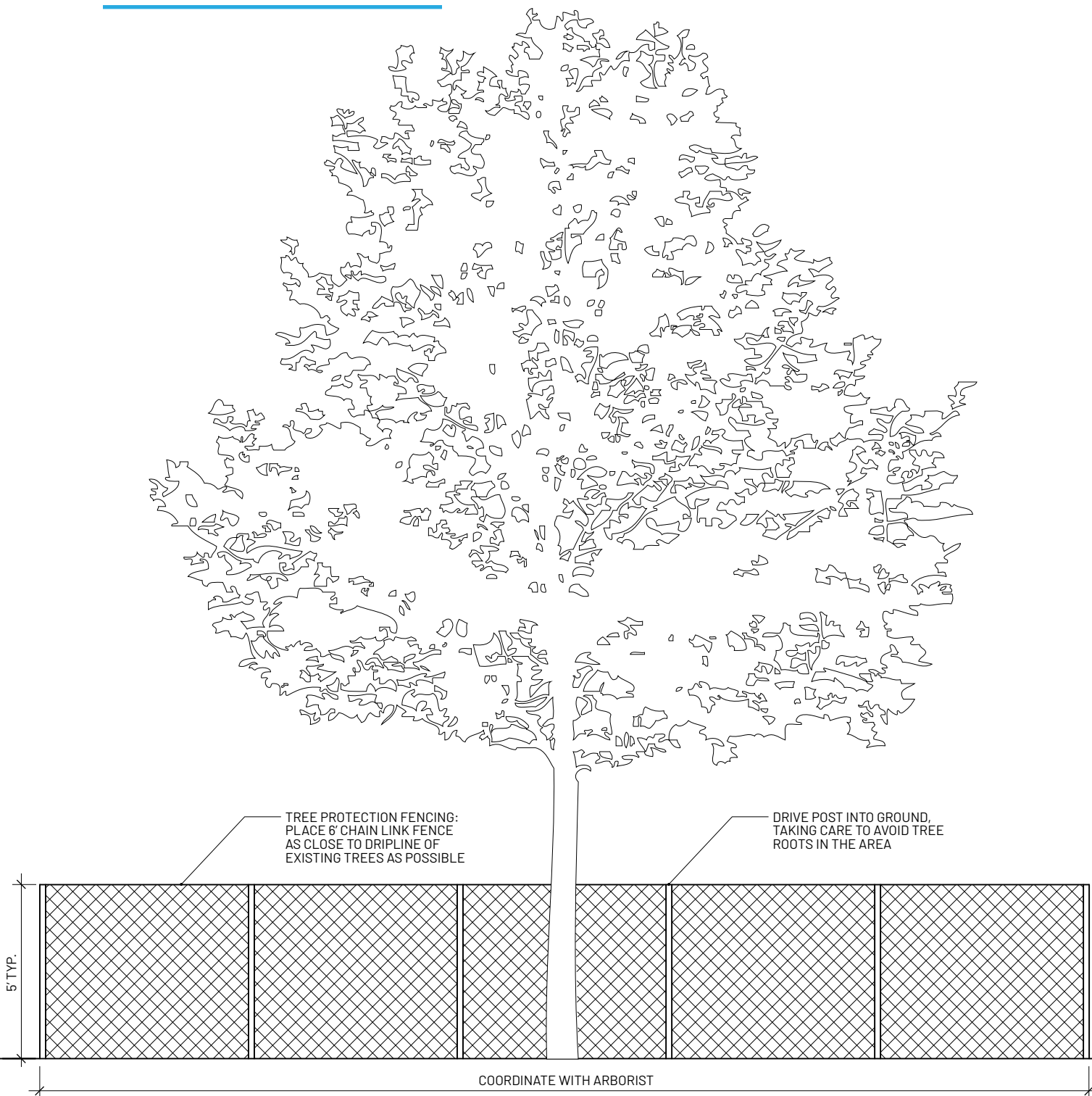
It is important to develop a maintenance plan for the plots that does not use pesticides or herbicides near crops. Utilize Integrated Pest Management, companion planting, insect repellent plants, biocontrol agents, and nontoxic pesticides to manage pests. Insect repellent plants include dill, thyme, lemongrass, lavender, basil, and chamomile. Additionally, strive to use organic mulch and compost. Rotate crops per season to prevent the buildup of diseases and insects specific to certain kinds of vegetables, and plan for the use of both warm season and cool season vegetables.<sup>28</sup>

Groundcover, shrub, vine, and canopy layers should all be considered when selecting edible plant species. It is important to consider species and foods that are culturally significant to the surrounding community. Plant species selection should also be conscious of any invasive pest or plant disease that could jeopardize the health of the plants and crop (such as the Asian Citrus Psyllid). Monitoring and maintenance programs should be adapted to any pest or disease as required. As with other plant species, only source material from qualified nurseries.

Examples of plant species that produce edible crop include, but are not limited to, the following:

- Trees: avocado (*Persea americana guatemalensis*), fig (*Ficus carica*), citrus (oranges, grapefruits, lemons), pomegranate (*Punica granatum 'Wonderful'*)
- Vegetables: artichoke (*Cynara scolymus*), kale (*Brassica oleracea var. acephala*), squash (summer and winter varieties), tomato, eggplant (*Solanum melongena*)
- Cactii: prickly pear (*Opuntia spp.*)
- Herbs: oregano (*Origanum*), rosemary (*Rosmarinus officinalis*), garden sage (*Salvia officinalis*), thyme (*Thymus*), chives (*Allium schoenoprasum*)
- Vines: raspberry (*Rubus*), peas (*Pisum sativum*), lima beans (*Phaseolus lunatus*)

ALL PROJECTS WITH EXISTING TREES  
MUST RETAIN AN ARBORIST TO REVIEW  
TREE HEALTH AND RECOMMEND  
PROCEDURES FOR PROTECTION,  
TRANSPLANTING, OR REMOVAL



### TREE ROOT PROTECTION

Figure 151. Tree protection should be coordinated with the project arborist. Protection fencing should be placed along the dripline of existing trees.

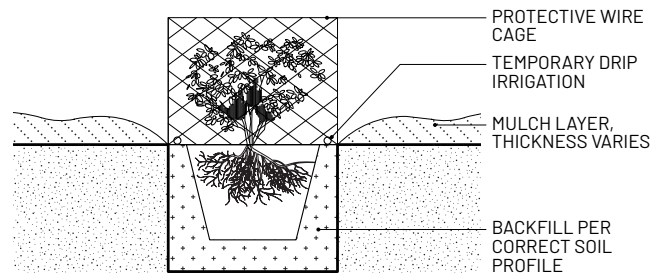
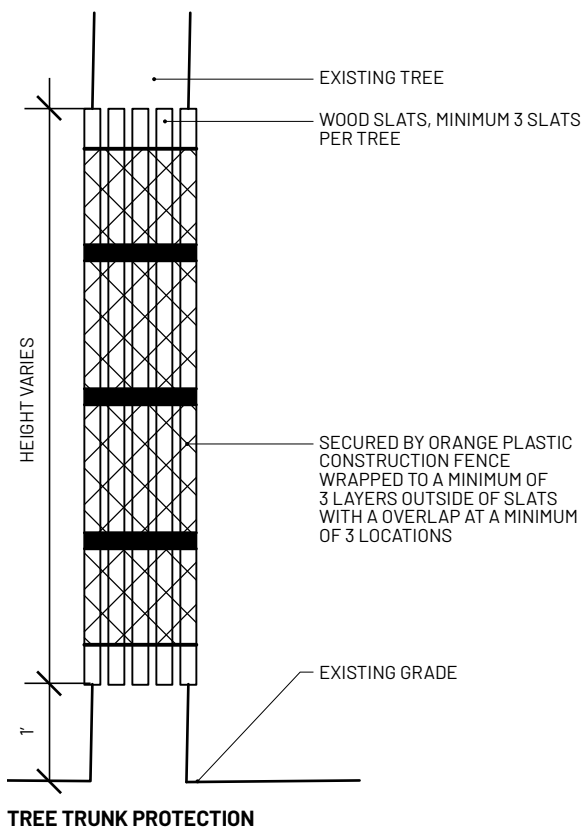
# TREE AND PLANT PROTECTION

Tree and plant protection is important in both protecting existing vegetation during construction and ensuring the survival of young plants after installation. In projects where habitat succession is key, tree protection fencing may be useful in ensuring that plants can establish themselves without disturbance. All projects with existing trees must retain an arborist to review tree health and recommend procedures for protection, transplanting, or removal.

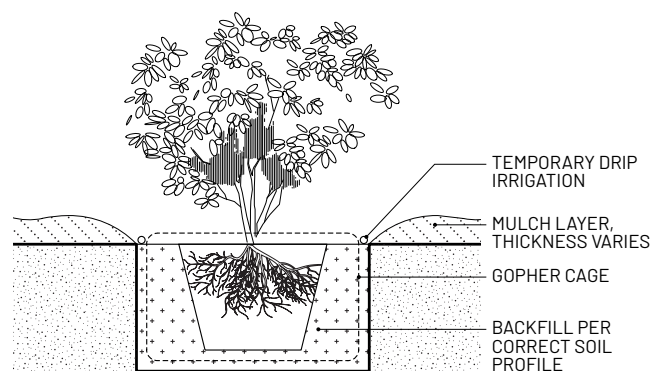
Tree protection zones are designated by tree protection fencing, which should be placed around the dripline of the existing trees. The zone should be established by the project landscape architect and arborist. Contractors are to keep soil disturbance within the tree protection zone to a minimum, excluding the use of heavy machinery. All digging in the zone is to be done by hand.

Tree trunk protection is another measure to further protect trees within the tree protection zone from damage during construction. Tree protection measures are temporary and meant to be in place during construction and removed afterward project completion. Adequate resources should be allocated for both installation and timely removal.

A combination of staking and installation of protective wire cages is recommended for small trees and shrubs to protect plants from vandalism and herbivory damage. In ground gopher cages may also be necessary to protect plant roots underground from squirrels, pocket gophers, and gophers.



**WILDLIFE SHRUB PROTECTION: CAGE**



**WILDLIFE SHRUB PROTECTION: GOPHER CAGE**

Figure 152. (Left) Tree protection also includes wood slats around the trunk of existing trees and they should be removed after construction.

Figure 153. (Top Right) Protective wire cages around shrubs susceptible to wildlife grazing can help protect them during establishment.

Figure 154. (Bottom Right) Gopher cages help protect shrub rootballs from burrowing wildlife during establishment.

# SITE PREPARATION AND SOIL

Planting failures are often a result of inadequate soil testing that would have guided a landscape architect, botanist, or ecologist towards a plant palette that could tolerate the present soil conditions. The landscape architect or planting designer should use the soil analysis results to determine the plant palette. Soil testing results are to be used to provide guidance for container planting, soil amending, and backfill conditioning. California native plants typically inhabit (and thrive in) areas with relatively low soil fertility. Therefore, the soils report fertility section must be interpreted by someone who is experienced and knowledgeable of California native plant horticultural requirements/parameters.

All existing soils should be tested to verify they are free of contaminants and debris and have the capacity to support adequate nutrients, drainage, and structure for a given planting design. Where possible, existing in situ soil materials should be amended in place after appropriate soil testing is conducted. Soil mix designs shall be based upon criteria of use. For example, soils designated for a given frame should balance the following criteria in the development of soil plans:

- **Ecological Rehabilitation**

Use a native soil type within the frame as a reference soil appropriate to the constructed context. A native reference soil will identify placement slope conditions, organic content, soil texture, and approximate pH as well as endemic vegetation supported by the soil material. Nutrient levels should also be based on this native reference soil condition.

- **Water Quality and Stormwater Management**

Refer to the Los Angeles County Public Works Low Impact Development Manual<sup>29</sup> for appropriate drainage classes and other functional criteria for vegetated swales, biofiltration, etc.

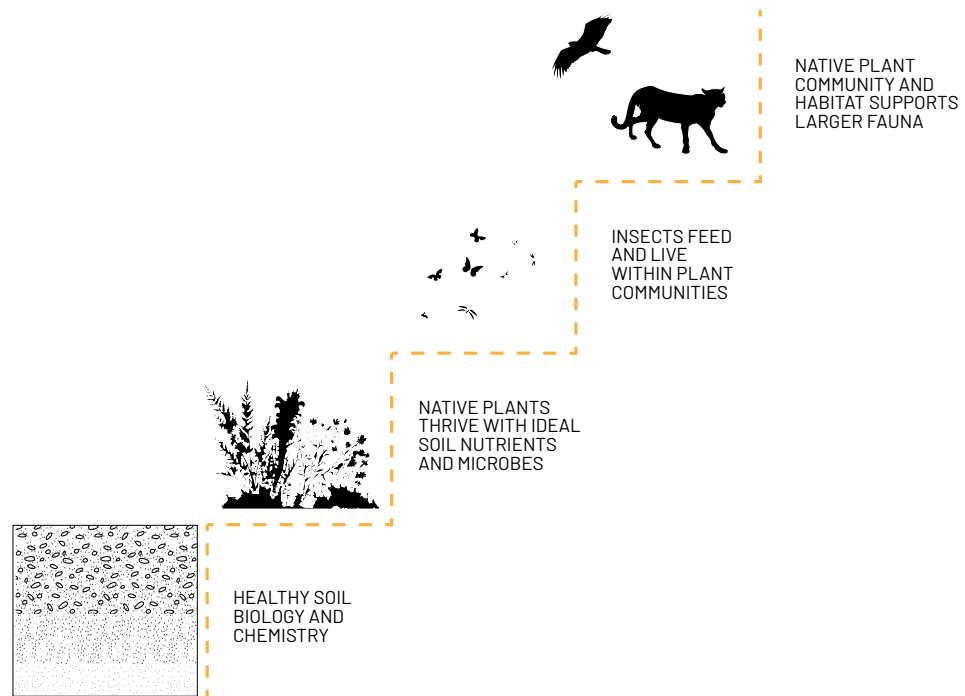
- **Recreational Areas**

Planted areas that receive high levels of foot traffic should be designed to resist compaction from foot traffic.

Further, all soils—amended, stockpiled or mixed—shall be tested for suitability. The Contractor shall submit representative samples of salvaged on-site topsoil, all plant mix materials, and organic material components which are intended to be used for planting soil mixes and final mixes to an independent Soil and Plant Testing Laboratory acceptable to the landscape architect. All tests shall be performed in accordance with the current standards of the Soil Science Society of America. All reports shall be sent to the landscape architect for approval. Samples of all soil materials to be brought to the site must be approved before delivery. Deficiencies in the soils shall be corrected by the Contractor, as directed by the landscape architect after review of the testing agency report.

Soil Amendment and Plant Mix analysis test methods shall show recommendations for soil additives, including organic and inorganic soil amendments, necessary to accomplish particular planting objectives noted.





**Figure 155. Ensuring proper soil testing and composition is crucial to supporting the life and structure of healthy functioning ecosystems. Soil mixes should be designed for it criteria of use, and all soils should be tested for suitability prior to installation.**

The following are minimum test criteria that should be specified by the landscape architect:

- pH and Buffer pH
- Analysis for levels of toxic elements and compounds
- Particle size analysis to include sand sieve analysis shall be performed and compared to the USDA Soil Classification System
- Percent of organic matter shall be determined based on organic carbon
- Carbon-to-nitrogen ratio shall also be reported to qualify the soil organic matter suitability
- Saturated hydraulic conductivity
- Analysis for nutrient levels
- Soluble Salt by electrical conductivity
- Cation Exchange Capacity

Organic and biological approaches to soil improvement are encouraged for consideration in the planting and management program. These approaches may include the addition of biological

infusions e.g., compost teas, mycorrhizal inoculations, and composted organic matter.

It is possible to alter soil conditions with a succession of plantings that will change the soil to eventually support a more diverse plant palette. At some project sites where soil contamination exists, it may be possible to utilize plants to assist in taking up toxins. However, that approach may be beyond most landscape budgets. Soil amendments are a possible alternative but should not be a part of standard planting specifications for these projects. Heavy soil contamination is a probable condition in areas along both entrenched and leveed conditions. Therefore, soils should be tested to determine its ability to retain and infiltrate water, soil fertility (macro and micro nutrients), biological activity, texture, toxics, salts, and heavy metals.

Importing soil mix materials will be required for some projects, particularly larger parks or gateways. All components for imported soil mixes should be sustainably sourced. Peat shall not be specified as a soil mix component. Landscape architects are encouraged to test and use innovative soils that promote the use of sustainable sources.

**FOR BOXED TREES AND SHRUBS:  
CAREFULLY REMOVE SIDES OF BOX AFTER PLACED IN PIT. WOOD  
BOTTOM MAY REMAIN IN PLACE. REMOVE ALL ROOT SECTIONS  
GROWING PARALLEL TO THE SURFACE OF THE ROOT BALL AND  
LOCATED AT THE ROOTBALL OUTER SURFACE GREATER THAN ¼ INCH.  
REMOVE SOIL AS NECESSARY TO UNCOVER ROOT FLARE**

---

## TREE AND SHRUB PLANTING

All plant material must be procured from a nursery that holds an appropriate nursery license with the California Department of Food and Agriculture (CDFA) to sell the requested plant material. Preference should be given to nurseries in southern California that are members of the Southern California Nursery BMPs Group. Contractor shall submit proof of license that all plant material was obtained by a pest free nursery in good standing with CDFA. Plant material quantities and handling standards must comply with the latest version of the American Standard for Nursery Stock (ANSI Z60.1) published by the American Horticulture Industry Association. Avoid purchasing plants affected by pathogens and use nurseries that incorporate best practices for pathogen avoidance.

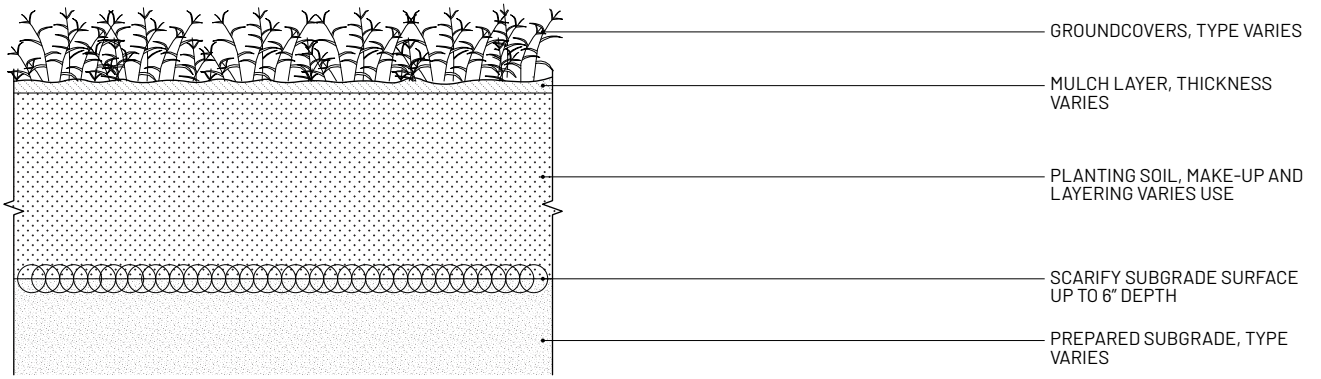
Planting of seed and container plants is to occur in late fall through winter to benefit from seasonal rains. The project landscape architect is to prepare a specific planting schedule for each project. Plants are to be established from smaller plant sizes where practical. Plants shall be well shaped, vigorous, with healthy, well developed root systems and not be rootbound. Plants shall be healthy, and free from disease, harmful insects and insect eggs, sun-scald injury, disfigurement, and abrasion. Plant pits shall be dug to produce roughened sides and flat, uncompacted bottoms. When pits are dug with an auger and the sides of the pits become glazed, the glazed surface shall be scarified. The size of plant pits shall be as indicated on drawings. Backfill for planting pits shall comprise amended site soil or manufactured soil media and organic compost depending on soil analysis results as specified by landscape architect.

Seed and container plants of indigenous natives are to be obtained through contracts with qualified seed companies and nurseries. The contractor shall acquire all seed material of the required type, sizes, and quantities through sources approved by the project landscape architect. The contractor shall submit seed supplier's certification and contact information confirming that the collected seed is exclusively from LA River watershed sources. If LA River watershed seed sources cannot be obtained contractor shall state reasons why material is unavailable, such as insufficient quantities or lack of seed stock. Seed not required to be labeled under the California Food and Agricultural Code shall be tested for purity and germination by a seed laboratory certified by the Association of Official Seed Analysts, or a seed technologist certified by the Society of Commercial Seed Technologists not more than one year prior to application of seed. Seed treated with mercury compounds shall not be used. Seed shall be delivered to the site in original sealed packages bearing the supplier's guaranteed analysis for percentages of mixture, purity, germination, hard seed, weed seed content, and inert material. Weed seed shall not exceed 1% by weight of the total mixture. Wet, moldy, or otherwise damaged seed shall be rejected.

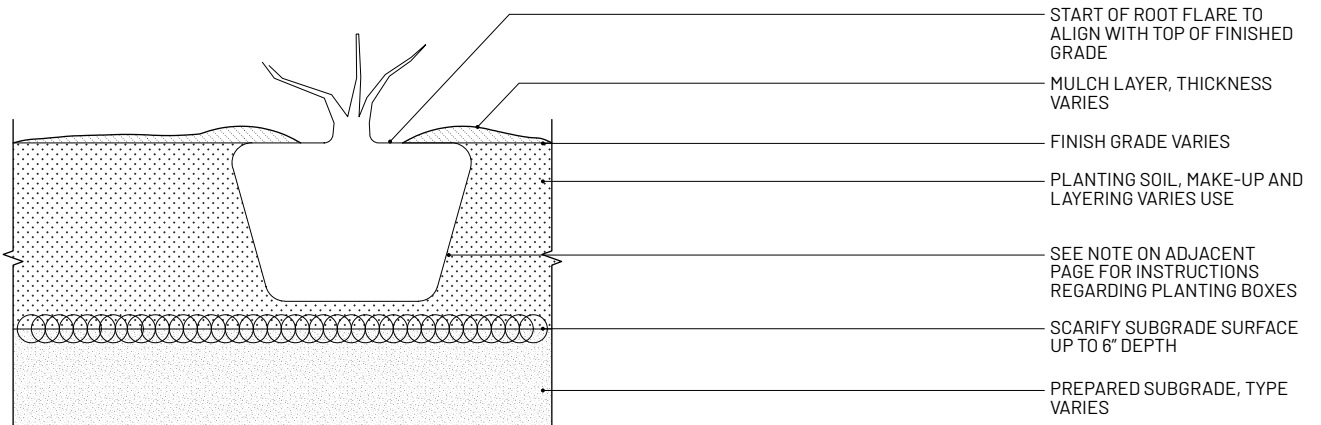
Each project is to be managed to provide adequate lead time for collection and propagation with the assistance of the project planting expert.

The subgrade should be scarified at least 6 inches deep before planting to ensure proper drainage. Seeded areas shall be lightly scarified. Finished grade shall be 1/2 inch below the adjoining grade of any paved area. New surfaces shall be blended to existing areas. All plants are to be thoroughly watered upon installation to compact soil and settle plants to natural soil depth. Planting areas that are not seeded are to be covered with 3-6 inches of organic mulch.

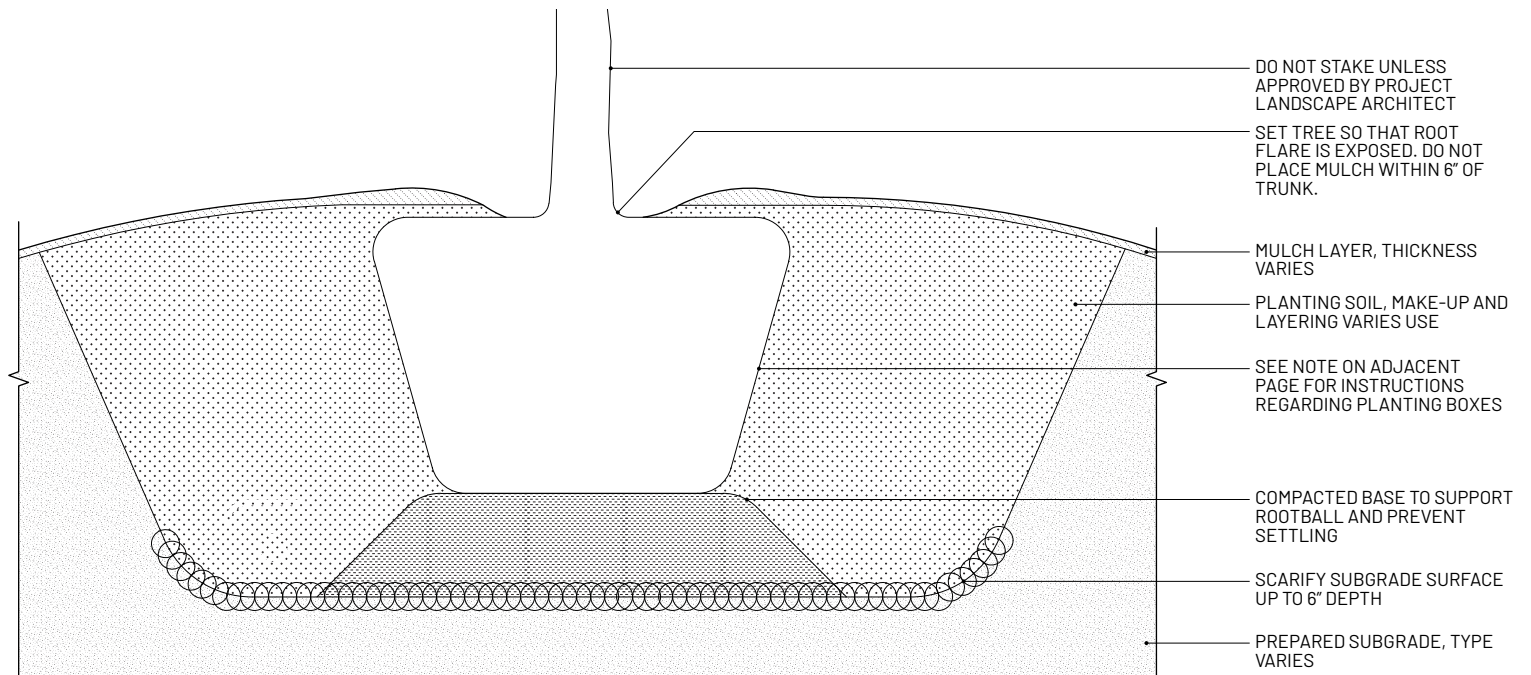




**GROUNDCOVER PLANTING TYPICAL DETAIL**



**SHRUB PLANTING TYPICAL DETAIL**



0 1/8" 1/4"

**TREE PLANTING TYPICAL DETAIL**

**Figure 156.** Planting installation methods should include scarifying the subgrade, aligning all root flares with the finished grade, and providing a compacted base for rootballs to provide the best growing conditions and allow the planted media to have the best chance of success.

# MAINTENANCE BEST PRACTICES

## EXTENDED MAINTENANCE PROGRAM

The project proponent is required to prepare a three year maintenance and monitoring program for all plantings and to designate who will be in charge of all short and long-term maintenance actions. This program is to define a schedule for observing and recording landscape performance with the goal of identifying actions that are needed to improve planting success. Such actions may include replacement plantings needed to replant areas where container plants have died or insufficient seed germination has occurred.

## SUPPLEMENTAL IRRIGATION

The design and installation of supplemental irrigation systems to sustain new landscape plantings is discretionary. Ideally, planting projects will establish communities of native plants in a manner that encourages self-reliance and survival after the first three years of planting. In this regard, irrigation systems may be designed to assist in the initial plant establishment stages or during times of intense drought, but consistent long-term watering is to be discouraged. An exception would be specialty plantings in high use recreation areas, at road intersections, or in highly paved areas. These types of planting areas may require additional supplemental irrigation for an extended number of years to maintain the vitality of the landscape.

The application of supplemental irrigation water for California native species is recommended primarily during the winter months with the intent to avoid winter drought stress to newly planted plants. Winter irrigation can be very helpful in maintaining soil moisture when there are long periods of time between winter rains. Summer and fall watering may be limited in accordance with prevailing site and environmental conditions until the following winter rain cycle begins.

After the first year of establishment, the decision to provide additional supplemental irrigation during the summer should be made by the landscape architect.

Where possible, recycled or reclaimed water should be used on projects for irrigation. If recycled or reclaimed water is used, total dissolved salts from the sources should be analyzed as many California natives cannot tolerate high levels of dissolved salts.

All irrigation supply and system components shall comply with the LA County Low Impact Development Manual, LA County water sources, conservation standards, and the current California Green Building Standards Code. Consult LA County Public Works Plan Check for irrigation system design and documentation requirements. Drip irrigation systems, when installed, should be capable of providing multiple emitters to each container plant. In areas of large open landscapes, drip irrigation should be carefully monitored for performance. Often wildlife can chew or dig up flexible drip irrigation lines in large landscapes. If practical hard pipelines are more durable. Strategies for mitigating damage should be developed through an integrated pest management approach, identifying the likely source of damage. For example, ground squirrels may be addressed with netting and landscape fabric, coyotes may require hard piping or other means. Alternatives to drip irrigation can also be considered depending on project needs and code compliance. Additionally, alternatives to poly-ethylene drip piping or other easily damaged materials may be implemented depending on project needs, budget, and code compliance. As-built drawings of all irrigation systems shall be completed and submitted to LA County Public Works for future use.



Figure 157. Native planting along the LA River, as seen here at the North Valleyheart Riverwalk at river mile 39.7, should be incorporated into the trail access points. Source: OLIN, 2019.

## PRUNING AND REMOVAL OF PLANTS

Landscape plantings are to be maintained in a manner that helps achieve natural form, diversity and density among plants. Trimming, pruning, and removal of plants is to be done under the guidance of a qualified native plant specialist and to avoid shearing and out-of-season cutting and pruning. Additional pruning and removal of plants shall be done to maintain public safety and access for service and emergency actions.

## INVASIVE SPECIES REMOVAL AND SUPPLEMENTAL MULCHING

The monitoring and maintenance program shall provide for routine landscape inspections to inspect and test irrigation systems, to manage weed growth, and to assess the need to provide periodic augmentation of mulches (to maintain a depth of 3-6"). Removal of invasive species by hand and mechanical means is recommended where feasible. Systemic herbicides that are glyphosate based such as Roundup or Rodeo SHOULD NOT be applied. Particularly aggressive invasive species, such as *Arundo donax*, spread by rhizomes and need careful consideration and monitoring when establishing a method for removal. Additional mulch is recommended to cover exposed soil and further inhibit the growth of weeds. Refer to LA County Weed Management Area Best Management Practices for Vegetation Management document (revised December 2015).<sup>30</sup>

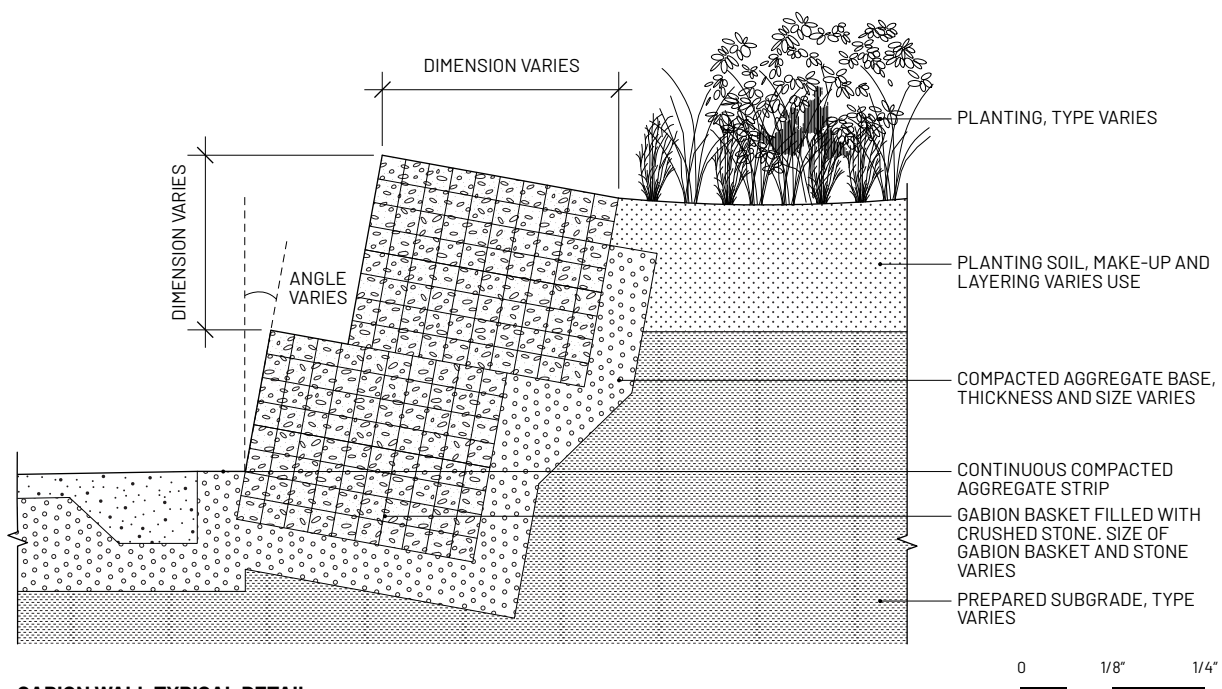
# WALLS

Site walls may be included in projects as barriers, seat walls, decorative elements with the potential for artwork, or to retain slope. Retaining walls are useful in projects that need to achieve a significant elevation change in a limited horizontal distance. They are a worthwhile investment where slopes need to be retained in a tight right-of-way condition.

Options for retaining walls include gravity or cantilever walls, constructed from concrete and stone, or can be gabion walls, consisting of steel wire cages filled with stone. Gravity walls are monolithic pieces of stone or concrete, while cantilever walls consist of two parts - a stem and a base. Gravity walls are recommended for smaller heights, while cantilever walls are more economic

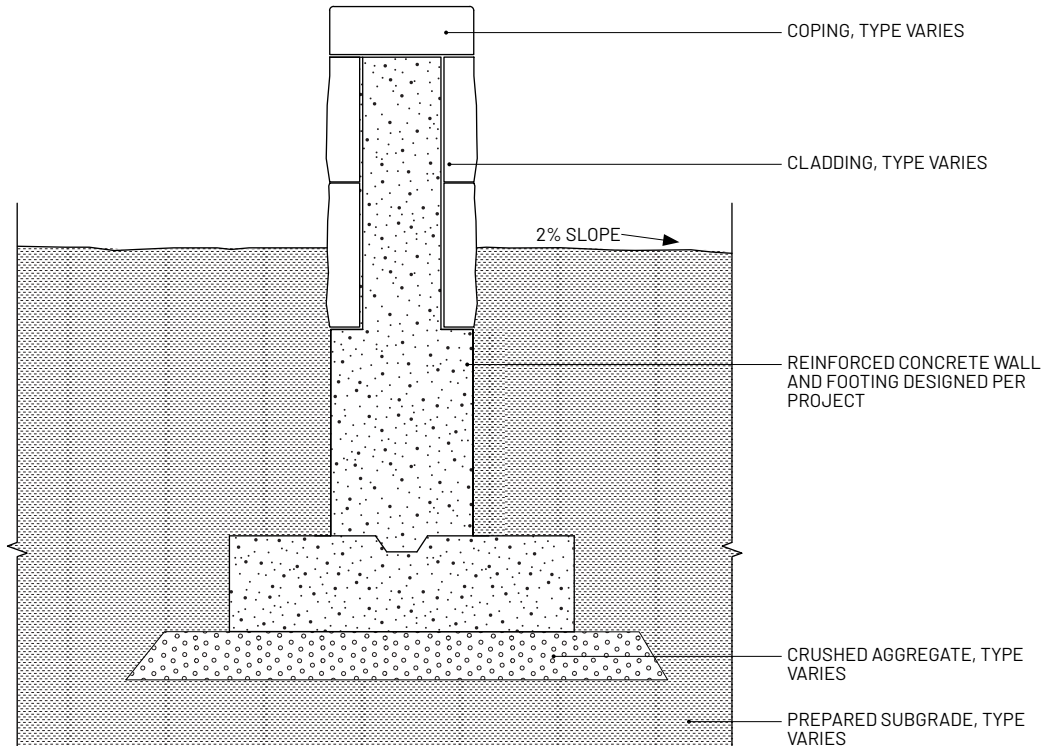
for height differences of 4 to 10 feet. Gabion walls are often a more economical wall option and can allow substantial vegetation growth near the wall. Gabions are often placed against the slope at a specific angle back against the slope. All retaining walls should be designed with a structural engineer to prevent wall failure.<sup>31</sup>

Walls also provide an opportunity for art and community expression. Other wall treatments, such as planting or textured treatments can also be considered to deter vandalism.



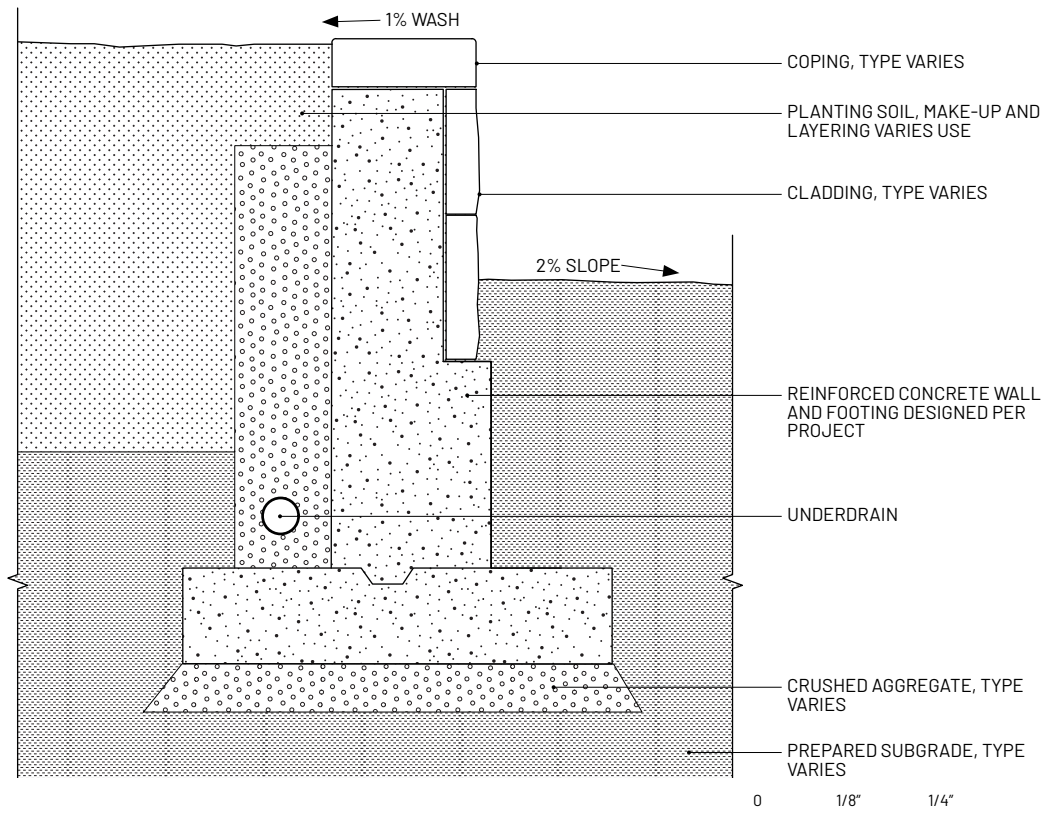
**GABION WALL TYPICAL DETAIL**

Figure 158. Gabion walls are often a more economical option for grade retention and allow for a substantial amount of planting near the wall. Gabion walls should be designed with a structural engineer.



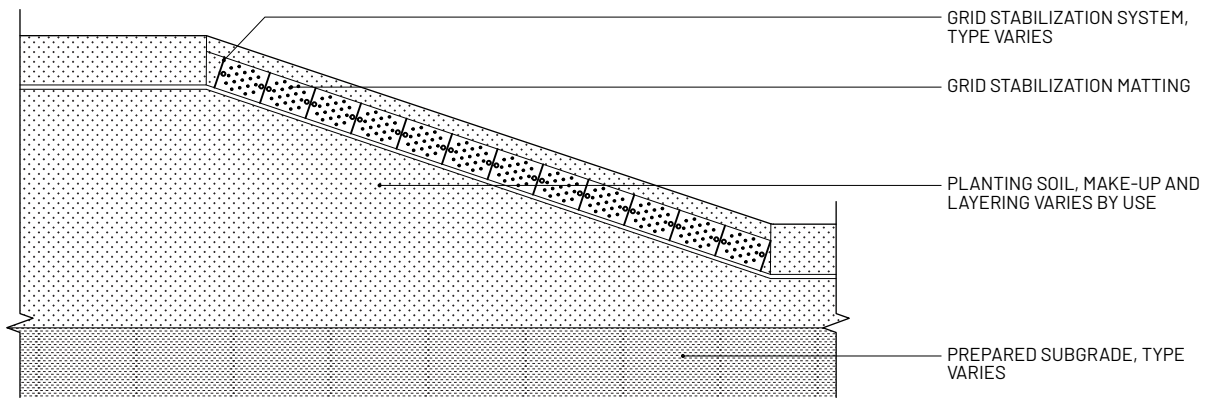
**SITE WALL TYPICAL DETAIL**

Figure 159. Site walls may function as barriers, seat walls, or decorative elements and should be designed with a structural engineer.

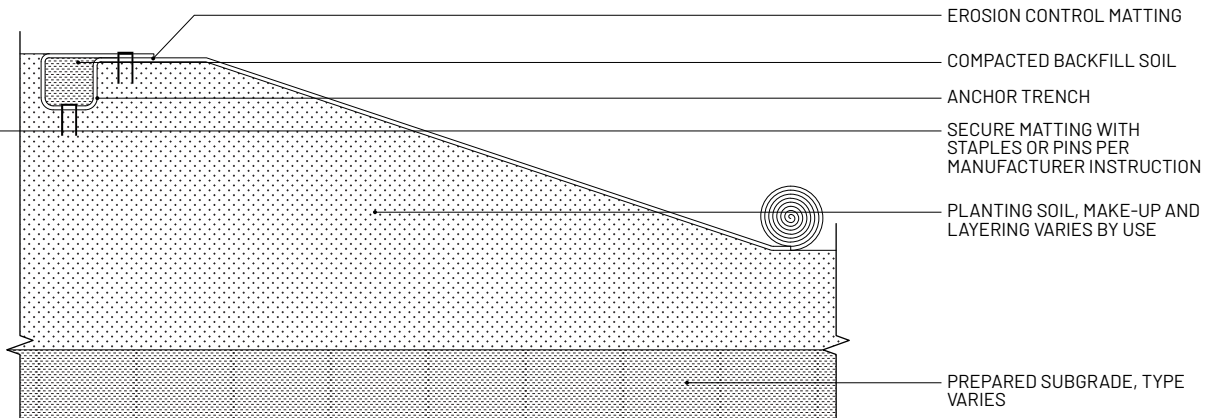


**RETAINING WALL TYPICAL DETAIL**

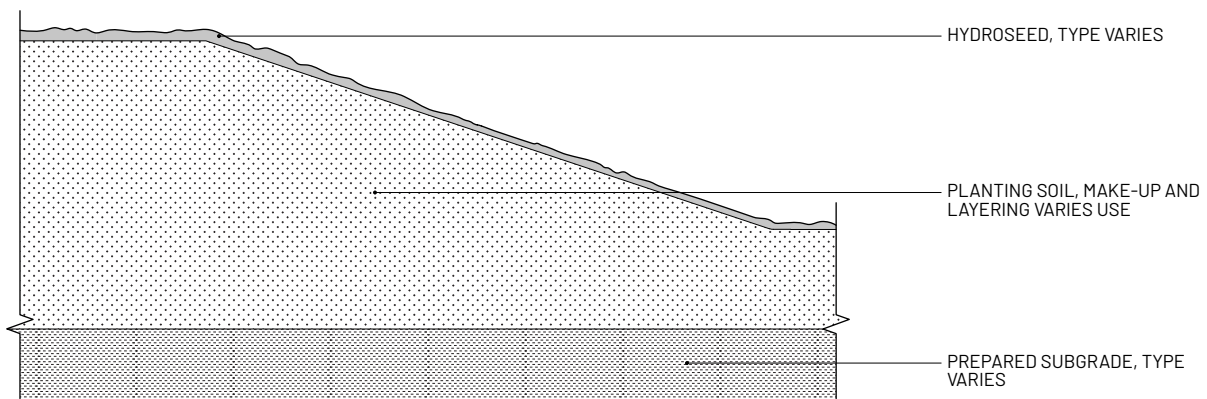
Figure 160. Retaining walls achieve a significant change in grade over a relatively narrow space and should be designed with a structural engineer.



**GEO-GRID EARTH STABILIZATION FOR LANDSIDE OF LEVEES**



**EROSION MAT STABILIZATION FOR LANDSIDE OF LEVEES**

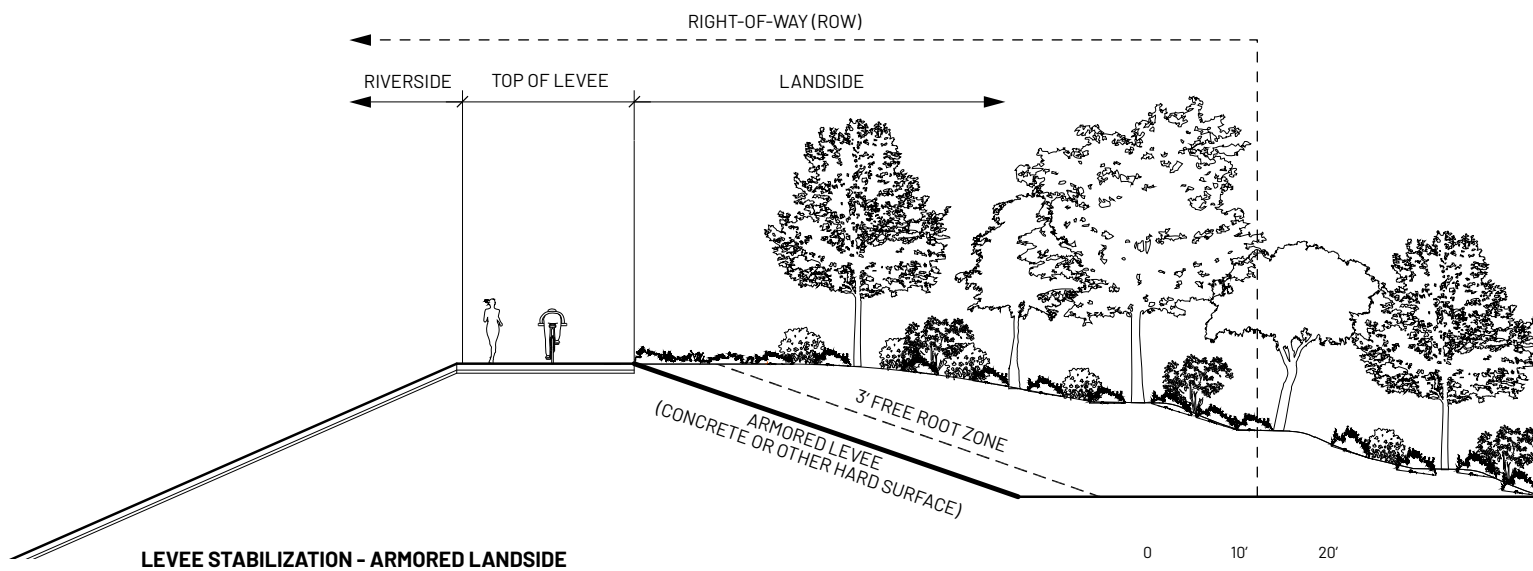


**HYDROSEED STABILIZATION FOR LANDSIDE OF LEVEES**



Figure 161. Geogrid mats, erosion mats, and hydroseeding are examples of strategies for slope stabilization on steep landside levee slopes. Slope stabilization should occur both during and after construction. The growth of deep rooting shrubs and groundcovers should be encouraged as a long-term slope stabilization method as permissible by levee planting standards.





**LEVEE STABILIZATION - ARMORED LANDSIDE**

Figure 162. Armoring the landside slope of a levee is a technique that helps prevent levee failure under extreme overtopping events and strengthens the resilience of the levee over time. It also allows for the construction of a planting berm that supports trees and shrubs.

## SLOPE STABILIZATION AND EROSION MANAGEMENT

In projects where slopes do not have a tight landside right-of-way constraint, slopes can range up to a 3:1 slope with vegetation. During and after construction, any exposed slopes should be treated to avoid dust and sediment erosion. There are multiple methods available, including geo-grid matting, erosion control matting, and hydroseeding. Encouraging the long-term growth of deep rooting shrubs and groundcovers is the most robust and environmentally-conscious slope stabilization method. In areas with gradual slopes and available right-of-way width, the use of slope contouring and swales on contour are a viable method for managing erosion and harvesting runoff. These techniques are meant to be deployed along the landside right-of-way only, as they would not be able to withstand the flood water velocities in the river channel.

Geogrid matting helps to stabilize steep slopes to prevent sliding. It often comes in a grid or waffle-like form, with gaps to allow planting to take hold. Erosion control matting reduces erosion by wind and runoff and also reduces runoff velocities and soil crusting. This protective covering should be of a natural, biodegradable woven material that helps to preserve soil moisture and lower soil temperatures, helping to establish more permanent vegetation over time while it biodegrades. Surface mulch for erosion control and weed abatement may comprise composted wood derivatives such as ground bark, chipped tree trimmings, or other wood waste material free of stones, sticks, and toxic substances harmful to plants and stabilized with nitrogen. Any stabilization of wood-based mulches with nitrogen should only be done at the direction of

a landscape architect, botanist, ecologist, or soil scientist experienced in the nutritional needs of native plant species. Hydroseeding is the act of spraying a mixture of native seeds, mulch, and binders onto a slope for temporary stabilization and to encourage the growth of both temporary and permanent vegetation. The binder in the mixture eliminates the need for matting to secure the mulch, thus allowing for easy application. Hydroseed fiber shall be produced from natural or recycled (pulp) fiber, such as wood chips or similar wood materials or from newsprint, chipboard, corrugated cardboard, or a combination of these processed materials, and shall be free of synthetic or plastic materials and shall be of such character that the fiber will disperse into a uniform slurry when mixed with water. The hydroseed and hydromulch mixtures should ideally be applied during the fall to take advantage of not only winter rains, but also the cold stratification that may enhance germination of many native plant seeds. Even in winter, hydroseed can fail if drought occurs. Hydroseed may require temporary irrigation to succeed in our climate. Drillseeding is another technique that can allow more seed-to-soil contact, and the depressions that result gather and infiltrate rainwater. Drillseed and hydroseed should not include non-native plants like annual ryegrass.<sup>32</sup>

For increased resiliency to flooding, armoring the landside of levees is a modification that would reduce the risk of levee failure under extreme overtopping events. Armoring methods such as hardening the levee with concrete or other hard material could be buried to allow for planting above.



## HISTORIC FIRE OCCURRENCES

# WILDFIRE

California native plant communities, especially chaparral and coastal sage scrub, are adapted to and thrive on occasional fires. Chaparral communities are shaped by infrequent, high-intensity wildfires rather than frequent fires; prior to mass development and presence of humans, natural, beneficial fires were likely to occur in intervals of 30 to 150 years, but with climate change and human activity, the increased frequency and intensity of wildfires are threatening native plants and habitats.<sup>33</sup>

Historically chaparral has been seen merely as fuel for fires and brush to be cleared rather than a native plant community worthy of being preserved.<sup>34</sup> However, more often the fuel for more intense wildfires is non-native, invasive grasses and forbs, which are rapid colonizers stoked by droughts and strong Santa Ana winds. Frequent fires cause native chaparral seeds and shrubs to die and limit shrub establishment, while invasive seeds are more likely to survive, further diminishing chaparral communities each recovery period. Restoring and protecting chaparral from excessive wildfire retains species diversity and slope stability, decreases erosion, increases water infiltration and carbon storage, and retains aesthetic integrity.<sup>35</sup>

While much of the LA River is in a densely urban context, planting projects near larger wildlife areas such as Griffith Park and Sepulveda Basin should be particularly careful not to increase fire risk. Furthermore, any existing larger ROW parcels that are converted to native vegetation should be designed and maintained to mitigate risks from fire.<sup>36</sup>

Wildfire mitigation strategies for native habitats along the LA River should focus upon eliminating invasive species, creating fuel breaks, and reducing fuel load where possible. The following can be considered as best practices:

- Remove invasive, non-native species during chaparral seeding or transplanting to aid in the establishment, survival, and recovery of native chaparral communities.<sup>37</sup>
- Prune dead plant material and remove plant debris to reduce fuel load. Pruning methods should maintain the natural form of trees and shrubs.<sup>38</sup>
- Consider spacing of canopy trees and large shrubs far enough to reduce the spread of fire.
- Maintain vertical separation between lower and upper fuel layers.<sup>39</sup>
- Minimize grasses and forbs, cut to four inches tall when they brown.<sup>40</sup>
- Reduce fuel load through mowing or machinery, grazing by animals such as goats, (NRCS Code 528), pruning (NRCS Code 660), removal, chipping, masticating, and/or sparingly through prescribed burning (NRCS Code 338).<sup>41</sup>



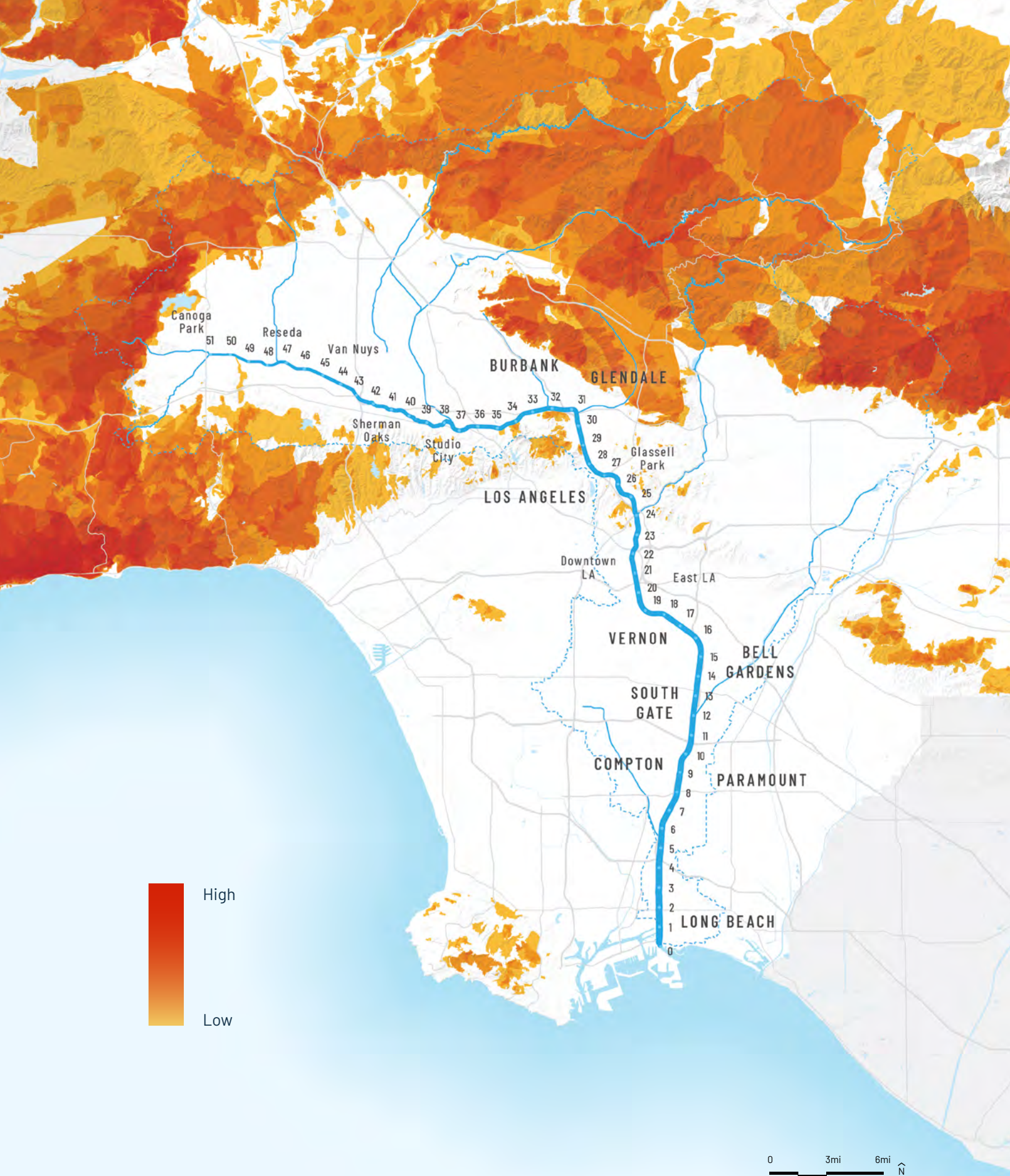


Figure 163. Historic Fire Occurrences Map. While native plant communities are adapted to occasional fires, the increased frequency of wildfires threatened the establishment of native shrubs and trees and favors non-native invasive species. Several design and maintenance strategies can help reduce this threat to native habitat. Source: State of California and the Department of Forestry and Fire Protection, Fire Perimeters Version 17.1, 2017.

## STRATEGIES FOR CREATING HABITAT

The historical vegetation of the LA River was a complicated landscape scale mosaic of predominantly willows, cottonwoods, sycamores, oaks, and marsh species. This historic, riparian vegetation is difficult to install within the confines of the present right-of-way due to limited access to water, changes in soil biotic activity and organic matter, and other alterations resulting from the development of the river channel system. The landscape architect should keep in mind the species and communities that probably existed along project river reaches and determine whether or not those species can still thrive within the constraints now existing along the river right-of-way.

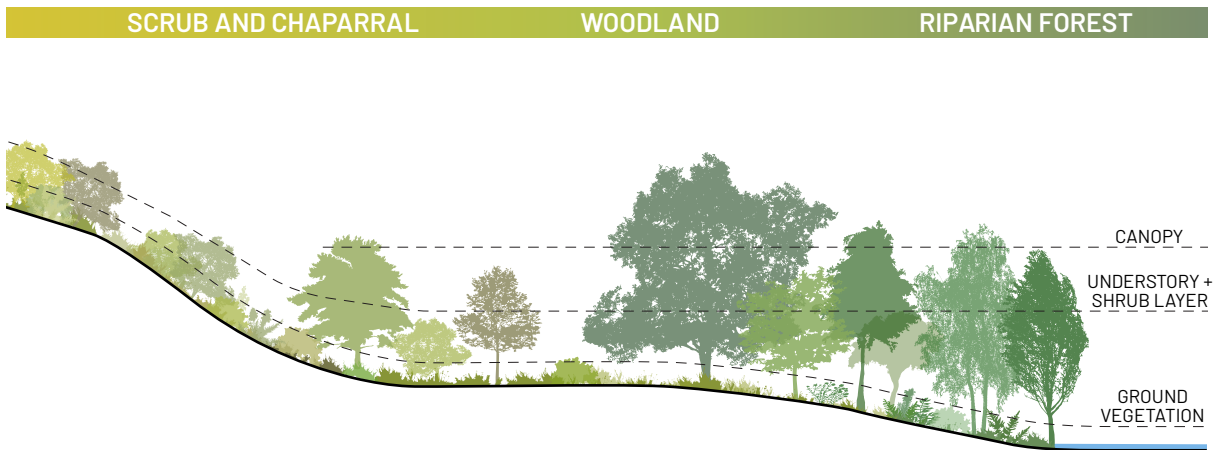
While restoration of riparian plant communities along the river is highly desirable ecologically, environmental conditions resulting from the existing infrastructure, maintenance requirements, and climate change may preclude the self-sustainability of such communities along much of the river. Therefore, many planting areas along the river may not be suitable for the historic riparian plant associations and other local native communities may be better suited depending on specific project goals and contexts.

Plantings are to be designed to include a range of native plants with the intent of achieving similar levels of species diversity as occurs in natural landscapes. Successional planting strategies from shorter lived perennials to established shrubs should be considered in planting design and maintenance. The diversity of the landscape plantings are to provide a variety of benefits ranging from soil development, erosion control,

and habitat value to educational benefit, native community ceremonies and harvesting, and other community involvement.

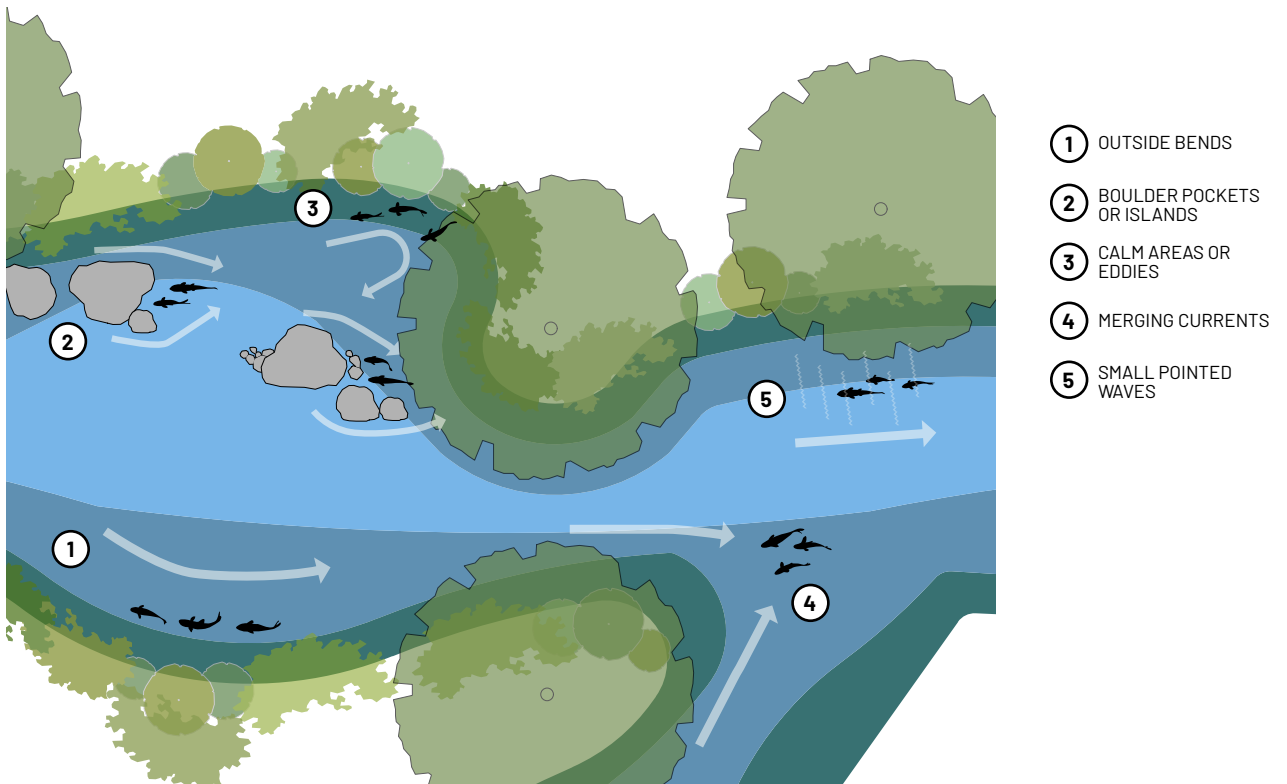
To enhance ecological health and achieve the richest wildlife habitat opportunities, designers should seek to achieve diverse vertical structure in their projects by including the full range of vegetative layers present in both the short list or the native community – from tree canopy where applicable, through mid-layer and understory species as enumerated on the lists. The arrangement of plants in plan should aim to mimic natural plant communities in terms of species type, quantity, and association to other species in the community. This helps to ensure compatibility and mutual support among the installed plant species. When designing habitats targeted for specific wildlife species, vegetation densities, landforms, and site features can be tailored to the needs of these species.

For example, when creating habitat for fish, features such as banks shaded by vegetation, eddies, calm areas, boulders or islands, and areas of merging currents all provide ideal places of refuge from predators and higher levels of nutrients for sustenance. Water depth, speed, and temperature all impact the success of a fish habitat as well. Habitat restoration projects should also consult a qualified botanist or ecologist. Additionally, any in-channel modifications should be informed and approved through hydraulic testing from a qualified engineer.



### PLANT COMMUNITY VERTICAL STRUCTURE

Figure 164. Vertical structure in planting varies depending on the type of native plant community. Woodland and forest communities tend to have large canopies, while scrub and chaparral communities tend to have primarily understory and shrub layers.



### RIPARIAN + WETLAND FISH HABITAT

Figure 165. Areas of refuge for fish include areas where nutrients accumulate or where protection of birds and other predators is offered, such as outer banks, shaded and calm areas, eddies, boulders or islands, and areas where currents merge. If working within the boundaries of the river channel, adding additional vegetation and boulders may impact flows and flood capacity of the river and should only be pursued with consultation of qualified engineers and hydraulic analysis. Source: "River Fishing." Takemefishing.org. Recreational Boating & Fishing Foundation. Accessed 2021. <https://www.takemefishing.org/freshwater-fishing/types-of-freshwater-fishing/river-fishing/>.



**DESIGNERS SHOULD SEEK TO ACHIEVE  
DIVERSE VERTICAL STRUCTURE AND  
HABITATS IN THEIR PROJECTS BY INCLUDING  
THE FULL RANGE OF VEGETATIVE LAYERS  
PRESENT IN THE PLANT COMMUNITY LISTS**

---

To facilitate reintroduction of plants from riparian and other rare plant communities, additional coordination should be conducted to allow for contract growing and collection of plant propagules from native sources. Planning in advance to allow for the necessary production timeline must be considered for contract growing as many growers require advance notice from nine months to a year in advance of purchase. Sourcing rare species or large numbers of plants for large-scale projects may need significantly more time.

Impacts from any prevailing pests and diseases, particularly those that target native trees, should be carefully considered with any proposed planting. Planting should be designed to increase and maintain biodiversity over time. Maintenance and monitoring plans should establish practices for the surveillance and treatment of species threatened by any insect or disease outbreaks.

Suitable conditions for native plant communities may also be achieved by strategic grading and drainage patterns that guide vegetated and urban runoff into artificial “riparian zones.” In areas with unrestricted soil depths, deep tillage of planting areas may be achieved by auguring the planting hole and breaking up hard subsoil layers. This strategy is strongly recommended for riparian tree species to provide a substrate through which developing tree roots can most readily reach the moisture they require for robust growth. The most common and broadly applicable

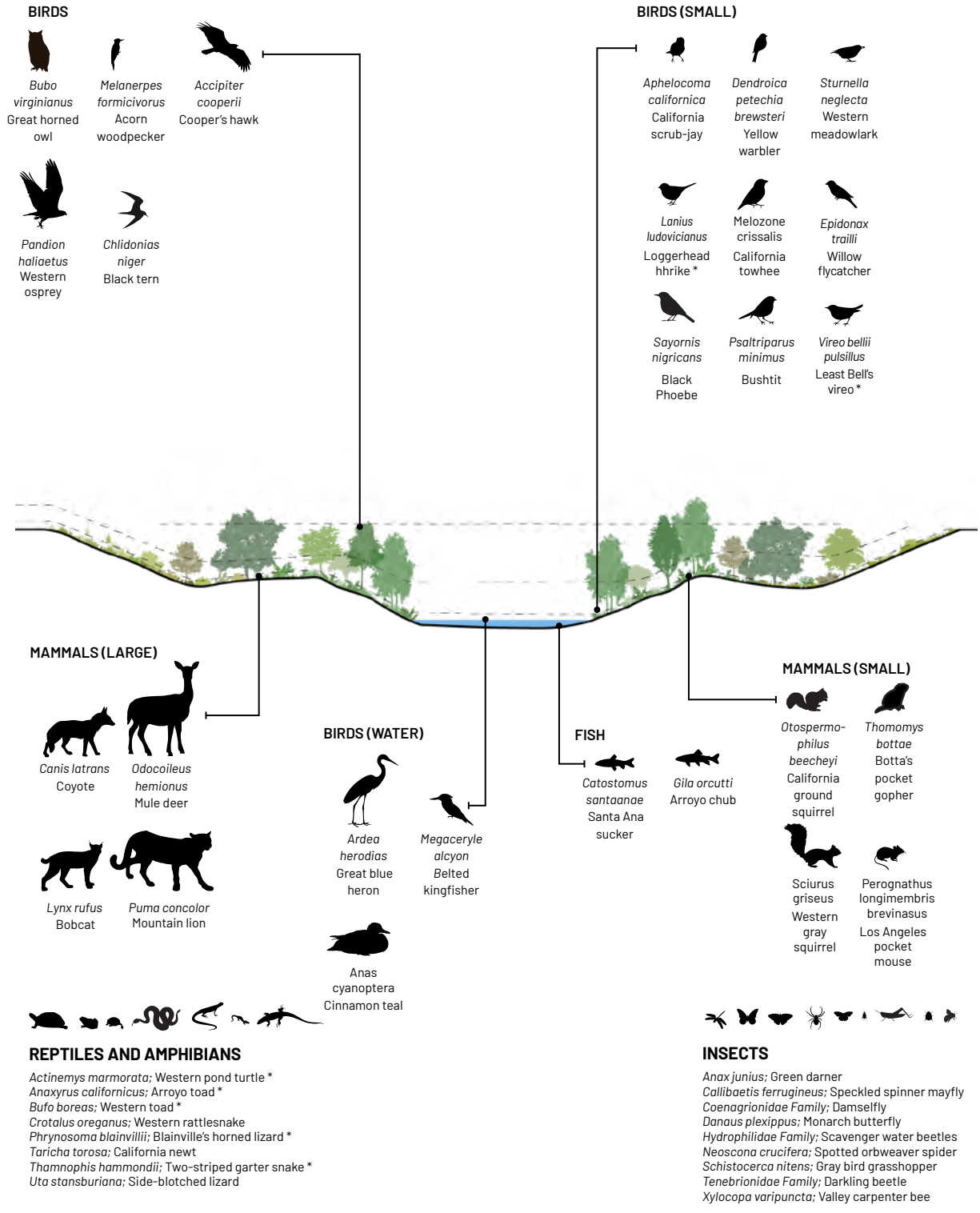
strategy to ensure success of planting is the type and timing of supplemental irrigation during the three-year course of the establishment period. It is important to gradually wean plants off of irrigation to avoid shock related to stress from reduced water levels. Irrigation techniques should be applied to encourage deep rooting, such as allowing irrigation to run less frequently but for longer consecutive hours so that the soil can soak deeply. Match water application to soil type and root zone depth to reduce water run-off and loss of water below the active root zone of the target plant type.

The following guidelines may be implemented, in accordance with the LA County Low Impact Development Manual, LA County water sources, conservation standards, and the current California Green Building Standards Code to establish native plant materials utilizing drip irrigation:

- Provide separate drip zones to plant materials with differing watering requirements, target root zone depths, and application requirements.
- Irrigation to be applied to within the entire mature dripline of trees and shrubs.
- Where possible, utilize irrigation approaches that allow for the phased expansion of the drip irrigation area as trees and shrubs mature.



UPLAND HABITAT      RIPARIAN HABITAT      UPLAND HABITAT



**SOFT-BOTTOMED BASIN BIODIVERSITY PROFILE**

Figure 166. Plant communities in different contexts can host diverse types wildlife. The example above shows a soft-bottomed basin condition of either an existing or proposed river section. The species listed are meant to be a snapshot of a full list to be developed with a qualified ecologist and assume appropriate soil and plant community health to support the wildlife species. For more details, reference Chapter 6 of Appendix Volume II: Technical Backup Document.

# HABITAT AREAS: OFF-CHANNEL FISHING AMENITIES

Where recreational fishing is encouraged in nearby wetlands or habitat areas, different amenities can be considered to allow for the safe and environmentally-conscious practice of fishing. Additional fishing locations may be established as fish habitat expands along the LA River and water quality improves. Consumption of any caught fish should be done only if prevailing conditions and agencies recommend it. Fishing areas provide an excellent opportunity for environmental graphics and interpretive signage that highlights best practices and habitat creation.

Off-channel fishing amenities may be appropriate for incorporation into projects using the Master Plan Kit of Parts for Channel Modifications, Crossings and Platforms, Floodplain Reclamation, and Off-channel Land Assets.

When locating off-channel fishing amenities, the following criteria should be considered:

## Aesthetics

- Select amenities without ornament or protrusions.
- For metal elements, utilize satin or matte finish solid metallic gray matching RAL 9007 or comparable equal.
- Use site context - sun exposure, water height, and propensity to flood - to inform the design and material selection of the fishing area. In areas of high sun exposure, add shade for comfort. Consider natural materials such as light-tone wood or recycled wood products that will not become overheated in the sun and will weather well.
- Consider adding seating and benches where space allows.



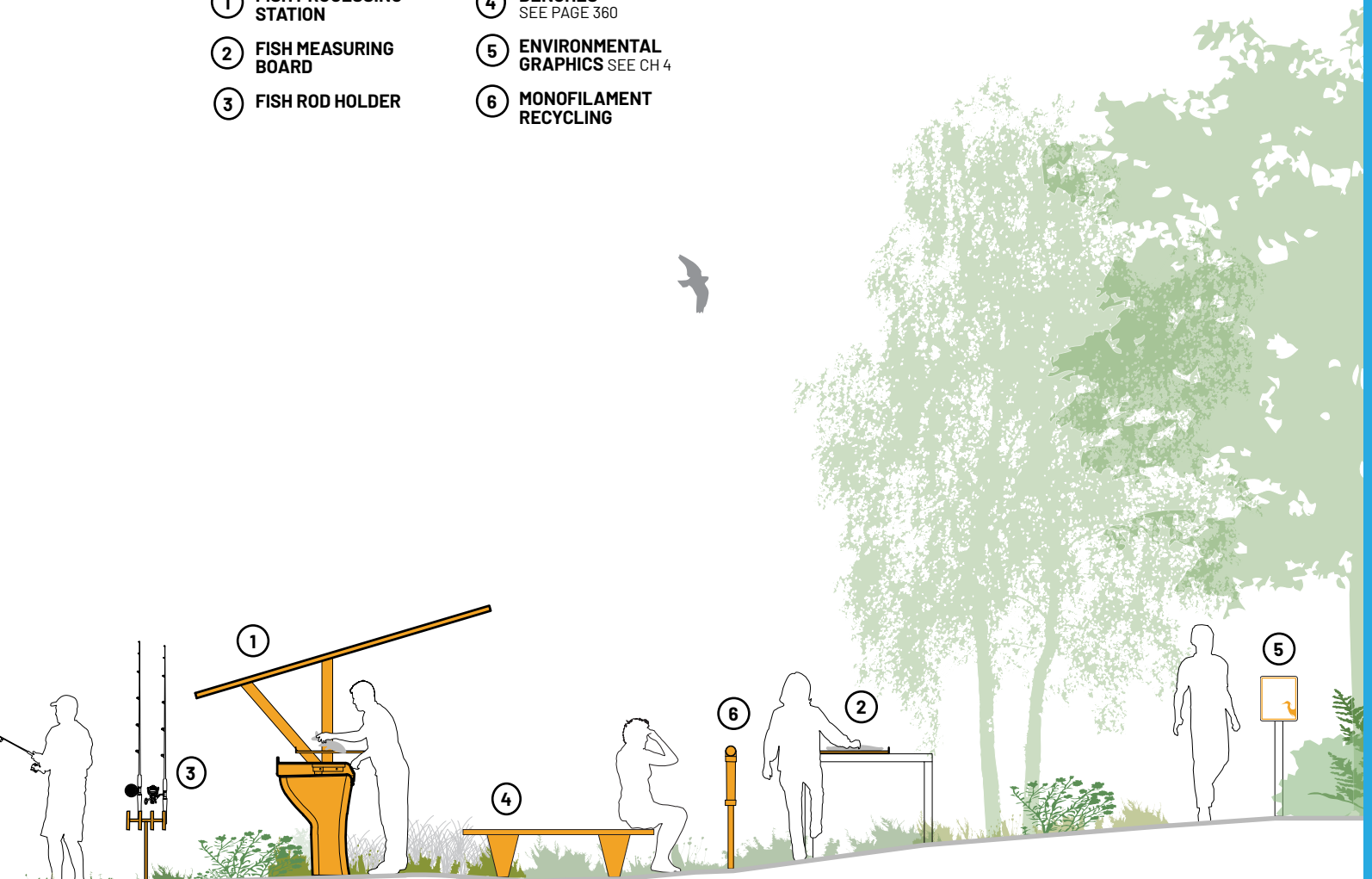
### Installation, Assembly, and Manufacturer

- Locate monofilament recycling receptacles, fish processing stations, and fishing rod holders all towards the end of the dock for ease in access.
- Ensure that any amenities for recreational fishing are anchored appropriately to the ground surface or railings per manufacturer's recommendations.

### Maintenance

- Maintain site amenities at a fishing area, deter graffiti where possible, and inspect for other damages.
- Coordinate maintenance program to ensure receptacles will be emptied regularly and that waste designated for fishing will be handled separately from other waste as required.

- ① FISH PROCESSING STATION
- ② FISH MEASURING BOARD
- ③ FISH ROD HOLDER
- ④ BENCHES  
SEE PAGE 360
- ⑤ ENVIRONMENTAL GRAPHICS  
SEE CH 4
- ⑥ MONOFILAMENT RECYCLING



#### HABITAT AREA ADJACENT TO THE LA RIVER CHANNEL

Figure 167. A variety of site furnishings can be placed in areas suitable for fishing. Fish processing stations are a valuable amenity for filleting fish. Typical fish processing stations include a wide cutting table, accessory tray, and attached hose for cleanup. Fishing rod holders and measuring boards can be installed to help keep the area free of clutter and also ensure that only the fish of appropriate sizes deemed by local fish and wildlife regulations are kept for processing, while the rest are caught and released.

# PLANT COMMUNITIES

The plant community lists have been developed through systematic review of several published sources regarding species distribution (see Bibliography in the Resources section), in combination with review of nursery and seed vendor lists. In most cases, these lists do not document every plant species that may be present within a native community and are not a substitute for a qualified botanist or ecologist for habitat-focused projects.

For example, many species of the alluvial fan sage scrub community are difficult to find in nurseries, including some of its signature species. However, this is the most appropriate community to install in the vicinity of Tujunga Wash and potentially other downstream locations. To facilitate reintroduction of this unusual community, additional coordination should be conducted to allow for localized contract growing and collection of plant propagules from local native sources.

Plant species nomenclature primarily follows Hickman, James C., ed. 1993. *The Jepson Manual: Higher Plants of California*. University of California Press, Berkeley and Los Angeles.

Plant community and association names are after Holland (1986) followed by Sawyer and Keeler-Wolf (1995).

Planting projects should follow this general criteria:

- Include the services of qualified planting experts who have proven experience with California native planting projects to assist in making decisions regarding the plant palette. These experts should include a registered landscape architect, arborist, and a qualified botanist or ecologist.
- Planting in the LA River channel should only occur where excess hydraulic capacity is confirmed.
- Plants currently existing in the public right-of-way are to be assessed for their value and role in new projects. Overall, long-term management actions and replacement plantings are to emphasize native species, invasive species removal, and self-sustaining habitats for future climate regimes.
- Planting can provide an opportunity to incorporate installed artworks or landart.
- Cooperative planning between LA River projects, local native plant nurseries, and native seed sources is imperative to supporting the increase in locally-sourced native plants. For large planting projects, contract growing the species needed is one strategy to ensure the locally-sourced native plants required are available.





**Figure 168.** The chaparral community is often found on exposed slopes and hillsides, such as this example in the Santa Monica Mountains. Source: Tracie Hall, <https://www.flickr.com/photos/twobears2/5190609445/> (Topanga State Park, 2010).



**Figure 169.** The coast live oak woodland can be found on slopes or on river banks and terraces, such as this example in Malibu Creek State Park. Source: Tracie Hall, <https://www.flickr.com/photos/twobears2/5193454253/in/photostream/> (Malibu Creek State Park, 2010).

ADDITIONAL NATIVE SPECIES NOT ON THE FOLLOWING PLANT LISTS MAY BE ADDED WITH THE DOCUMENTED RECOMMENDATION OF A QUALIFIED BOTANIST OR ECOLOGIST

## NATIVE PLANT SPECIES APPROPRIATE USE

The following native plant species that are not included on the plant community lists may be planted:

- Annuals and bulbs (which have higher maintenance requirements)
- Cultivars of the native species listed (use with caution in projects that interface with wildlands)
- Additional LA County native species recommended by a qualified botanist or ecologist

The following plants should never be planted along the LA River:

- Non-native invasive plant species defined by the California Invasive Plant Council (Cal-IPC) <https://www.cal-ipc.org/>

Additional information is on both native and invasive species is available through the California Native Plant Society: <https://www.cnps.org/>

In riparian or other native habitat areas within the LA River right-of-way, the following criteria for species selection should be followed:

- **95% minimum** of the total number of plants of the same pot size should be LA River Watershed native species (refer to the native plant community lists in this chapter).
- **5% maximum** of the total number of plants of the same pot size should be native to Los Angeles' Level III ecoregion (Southern California/Northern Baja Coast; Southern California Mountains).
- **10% minimum** of the total number of LA River Watershed native plants of the same pot size should be locally sourced in the LA River Watershed. Higher percentages should be achieved as local supply capacity increases.

### NATIVE PLANT SPECIES TERMS & DEFINITIONS

**LA River Watershed Native Plant Species:** Plant species that are a part of the balance of nature that has developed over hundreds or thousands of years in the LA River Watershed. (Source: USDA)

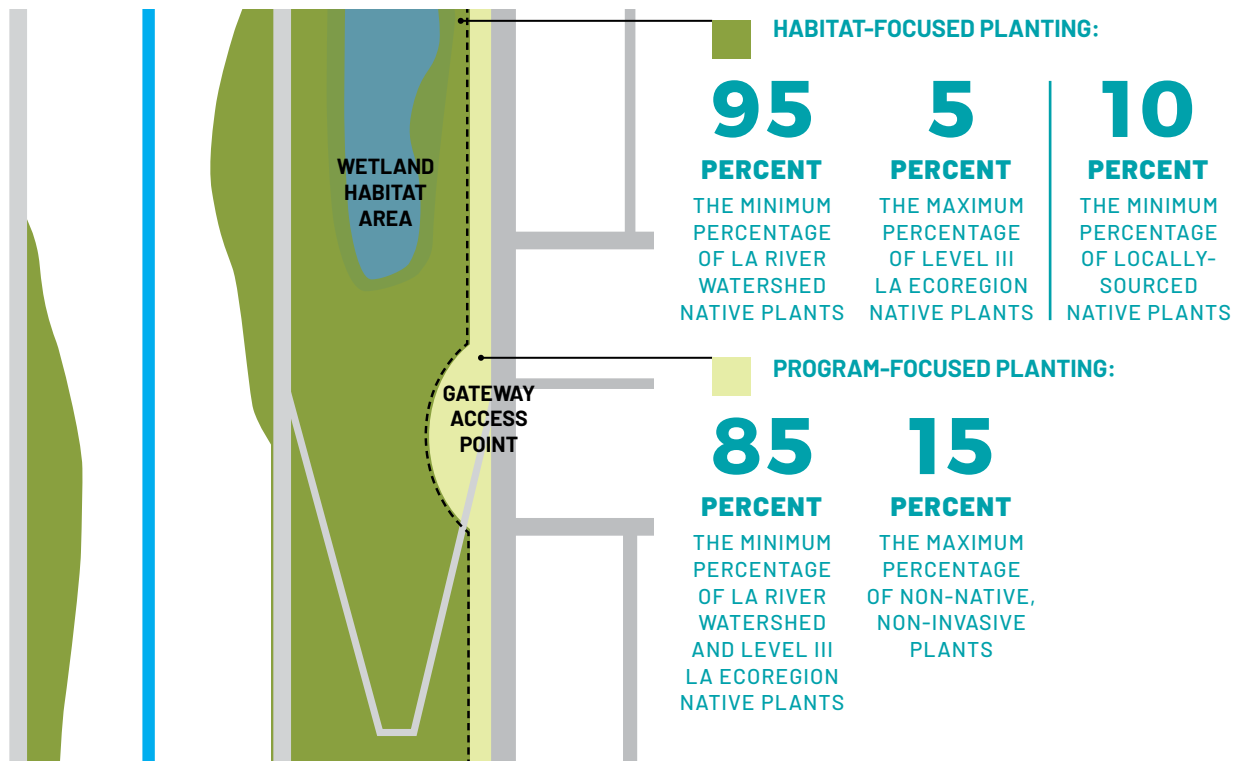
**Non-Native Invasive Plant Species:** Plant species that are both non-native and able to establish on many sites, grow quickly, and spread to the point of disrupting plant communities or ecosystems, causing environmental harm and/or harm to human health. (Source: USDA)

**Non-Native Plant Species:** A plant species introduced with human help (intentionally or accidentally) to a new place or new type of habitat where it was not previously found. Not all non-native plants are invasive and may not reproduce or spread readily without continued human help. (Source: USDA)

**Ecoregions:** Areas where ecosystems (and the type, quality, and quantity of environmental resources) are generally similar. This framework is derived from mapping done in collaboration with USEPA regional offices, other Federal agencies, state resource management agencies, and neighboring North American countries. (Source: USEPA)

Figure 170. Terms and Definitions for Native Plant Species. Terms are defined as used in this document. Source: USDA, USEPA.





\*Planting in the LA River channel should only occur where excess hydraulic capacity is confirmed.

Figure 171. Species planting at gateways and along street frontages can incorporate more climate-adapted species, while riparian and other habitat areas should prioritize planting locally-sourced LA River watershed native plant species.

Programmed areas, gateways, or areas where the project interfaces with the city street grid within the LA River right-of-way, the following criteria for species selection should be followed:

- **85% minimum** of the total number of plants of the same pot size should be native to the LA River Watershed (refer to the native plant community lists in this chapter) or the Level III ecoregions of Los Angeles and just east of Los Angeles, as appropriate per planting context and climate regimes (Southern California/Northern Baja Coast; Southern California Mountains; Mojave Basin and Range; Sonoran Basin and Range).
- **15% maximum** of the total number of plants of the same pot size can be climate-adapted, non-native, non-invasive species.

All plant species selections should be made based on the specific goals and needs of a project. These percentages are a baseline benchmark and projects are encouraged to go over and beyond these requirements to meet project goals. Any variance to these requirements may be considered on a case-by-case, plant-by-plant basis by the county.

The following program areas within the LA River right-of-way can be considered special-use zones and are exempt from the native planting requirements:

- Recreation and sports fields
- Urban agriculture and orchards

# PLANTING LIST KEY

## APPLICATIONS

**+**  
Enhances biodiversity, and provides habitat - especially for key indicator species for each community

**^**  
Mature tree canopy, provides significant shade for pedestrians

**\***  
Tolerates heat

**~**  
Tolerates flooding

**!**  
Useful for soil/bank stabilization

**o**  
Additional moderate to high levels of irrigation required if existing groundwater or riparian conditions are not available

## SUN EXPOSURE

**FS**  
Full sunlight

**FS/PS**  
Full Sunlight to Partial Sunlight

**PS**  
Part Shade

**PS/FS**  
Part Shade to Full Shade

SOUTHERN COTTONWOOD-WILLOW RIPARIAN FOREST

## SPECIES

BOTANICAL NAME	COMMON NAME
<b>SHRUBS</b>	
<i>Baccharis salicifolia</i>	Mulefat
<i>Pluchea sericea</i>	Arrow weed
<i>Rhus aromatica</i>	Fragrant sumac

## SITING + PERFORMANCE

FRAMES FOR BEST PERFORMANCE

CONSTRUCTED CONTEXTS

APPLICATIONS

SUN EXPOSURE  
SETBACK FROM PAVEMENT (FEET)

## FRAMES (SEE CH. 2 FOR MORE EXPLANATION)

### 1 - Estuary

Significant bird habitat; brackish water all year long; raised banks allow for planting; opportunity for coastal wetlands

### 2 - South Plain

Significant bird habitat; freshwater in channel; algae mats could be preserved as food source for birds; wide right-of-way provides opportunity for significant habitat areas, including wetland construction

### 3 - Central Plain

Lack of habitat and park space; urban heat island mitigation and shade needed; potential for habitat patches to connect significant ecological areas

### 4 - North Plain

Lack of habitat and park space; urban heat island mitigation and shade needed; harsh environment with pollution and soil contamination prevalent

### 5 - Heights

Lack of habitat and park space; urban heat island mitigation and shade needed; potential for habitat corridor connection and patches to connect significant ecological areas

### 6 - Narrows

Significant opportunity to enhance native habitat and connect to other important habitat corridors and patches; natural riparian to upland connections are possible here

### 7 - East Valley

Dense residential context; narrow right-of way; significant opportunity to enhance native habitat and connect to other important habitat corridors and areas

### 8 - Mid Valley

Dense residential context; narrow right-of way; opportunities for park space, shade, and urban heat island mitigation; opportunity to enhance native habitat and connect to other important habitat corridors and areas

### 9 - West Valley

Dense residential context; significant opportunity to enhance native habitat and connect to other important habitat corridors and patches; potential to connect to headwaters from this frame

## CONSTRUCTED CONTEXTS

**A**  
Steep slopes, fast draining, thin soil profile

**B**  
Steep slopes, fast draining, thin soil profile (North-facing)

**C**  
Level slope or terrace, fast draining with drier soils

**D**  
Planting bed and soils surrounded by paving. Drier soils, hotter than usual ambient temperatures

**E**  
Level slope or terrace, fast draining with intermittently flooded soils

**F**  
Low-lying alluvial or gravelly soils that are seasonally flooded

**G**  
Low-lying alluvial soils or gravelly soils with regular access to water

## OCCURRENCE IN NATURAL COMMUNITIES

### Dominant

Visually dominant in the mature landscape; usually refers to trees or large shrubs.

### Subdominant

Visually subdominant.

### Frequent

Refers to the numerical proportion of the species in the landscape. Especially in the case of grasses and herbaceous species, this category may indicate much higher numbers of individual plants than the dominant category, but these species do not dominate the casual vista.

### Occasional

Refers to plants that occur occasionally in the designated plant community.

## BLOOM SEASON

### W

Winter

### SP

Spring

### SU

Summer

### F

Fall

## DESCRIPTIVE FEATURES

PLANT FORM	WATER USE (WUCOLS IV)	MATURE HEIGHT (FEET)	MATURE WIDTH (FEET)	SHORTLIST PLANT	USACE NATIVE PLANT LIST	SEED LA TARGET LIST	OCCURRENCE IN COMMUNITY	OFTEN AVAILABLE IN CA	POLLINATOR HABITAT	BLOOM COLOR	BLOOM SEASON			
											W	SP	SU	F
S	H	4-8	6-10	X	X		Occasional	X	Bees, Butterflies	White/Pink/White	X	X	X	X
S	M	6-8	6+	X			Occasional	X		Pink		X	X	
S-D	L	3-5	4-8		X		Frequent - Occasional		Birds	Yellow/Cream		X		

## WATER USE

WUCOLS: Estimates water needs based on the latest prevailing legislation. These water use categories used to develop hydrozone plans and submitting permitting applications. See <https://ucanr.edu/sites/WUCOLS/> for more information.

### VL

Very low

### L

Low

### M

Medium

### H

High

## PLANT FORM

### T

Tree

### D

Deciduous

### S

Shrub

### SC

Succulent

### G

Grass

### GC

Groundcover

### P

Perennial

### V

Vine

### A

Annual

PLANT PALETTE SELECTION IS HEAVILY DEPENDENT ON THE EXISTING CONDITIONS OF CHANNELIZATION (ENTRENCHED OR LEVEED), NATIVE OR IMPORTED SOIL CONDITIONS, ACCESS TO WATER, SUN EXPOSURE AMOUNT OF SHADE, RIGHTS-OF-WAY WIDTH VARIATIONS AND ADJACENT LAND USES

# PLANT SPECIES INDEX

This index lists all species that appear in the following plant community lists. Some species occur in multiple communities.

Each community can be found starting on the following pages:

- Shortlist (SH) on page 222
- Alluvial Fan Sage Scrub (AFSS) on page 230
- Coastal Sage Scrub (CSS) on page 238
- Chaparral (CH) on page 246
- Southern Coast Live Oak Riparian Forest (CLORF) on page 254

BOTANICAL NAME	COMMON NAME	PLANT COMMUNITIES
<b>TREES</b>		
<i>Acer negundo</i>	Box elder	CLORF, CWRF, SRW
<i>Adenostoma sparsifolium</i>	Red shanks	CH
<i>Alnus rhombifolia</i>	White alder	SH, SRW, PFEW
<i>Arbutus 'Marina'</i>	Marina madrone	CT
<i>Calocedrus decurrens</i>	Incense cedar	CT
<i>Celtis laevigata</i> var. <i>reticulata</i>	Western hackberry	DS
<i>Cercis occidentalis</i>	Western redbud	CT
<i>Chilopsis linearis</i>	Desert willow	DS, CT
<i>Chitalpa tashkentensis</i>	Chitalpa	CT
<i>Cordia boissieri</i>	Texas wild olive	CT
<i>Cupressus arizonica</i>	Arizona cypress	CT
<i>Dalbergia sissoo</i>	Indian rosewood	CT
<i>Forestiera neomexicana</i>	Desert olive	CT
<i>Fraxinus velutina</i> var. <i>coriacea</i>	Velvet ash	CLORF, CWRF, SRW, VOW
<i>Hesperocyparis forbesii</i>	Tecate cypress	CT
<i>Juglans californica</i> var. <i>californica</i>	California walnut	SH, CH, CLORF, CLOW, SRW, WW
<i>Laurus nobilis</i>	Sweet bay	CT
<i>Lophostemon confertus</i>	Brisbane box	CT
<i>Lyonothamnus floribundus</i> ssp. <i>asplenifolius</i>	Ironwood	CT
<i>Olneya tesota</i>	Desert ironwood	CT
<i>Parkinsonia florida</i>	Blue palo verde	DS
<i>Pinus canariensis</i>	Canary Island pine	CT
<i>Pinus coulteri</i>	Coulter pine	CT
<i>Pinus eldarica</i>	Eldarica pine	CT
<i>Pinus halepensis</i>	Aleppo pine	CT
<i>Pinus muricata</i>	Bishop pine	CT
<i>Pinus pinea</i>	Stone pine	CT
<i>Pinus torreyana</i>	Torrey pine	CT
<i>Platanus racemosa</i>	California sycamore	SH, AFSS, CLORF, CWRF, SRW, VOW

BOTANICAL NAME	COMMON NAME	PLANT COMMUNITIES
<i>Populus fremontii</i> ssp. <i>fremontii</i>	Fremont cottonwood	SH, CLORF, CWRF, SRW, PFEW
<i>Populus trichocarpa</i>	Black cottonwood	CLORF, CWRF, SRW, PFEW
<i>Quercus agrifolia</i> var. <i>agrifolia</i>	Coast live oak	SH, AFSS, CLORF, CLOW, SRW, VOW, WW
<i>Quercus chrysolepis</i>	Canyon live oak	CT
<i>Quercus douglasii</i>	Blue oak	CT
<i>Quercus engelmannii</i>	Engelmann oak	CT
<i>Quercus lobata</i>	Valley oak	SH, VOW
<i>Quercus wislizeni</i>	Interior live oak	DS
<i>Quillaja saponaria</i>	Soapbark tree	CT
<i>Salix gooddingii</i>	Black willow	CWRF, SRW, PFEW
<i>Salix laevigata</i>	Red willow	CWRF, PFEW
<i>Sambucus nigra</i> ssp. <i>caerulea</i>	Mexican elderberry	SH, AFSS, CSS, CLORF, CLOW, CWRF, SRW, WW, PFEW
<i>Searsia lancea</i>	African sumac	CT
<i>Tipuana tipu</i>	Tipu tree	CT
<i>Umbellularia californica</i>	California bay laurel	SH, CLORF, CLOW, CWRF, SRW
<i>Vitex agnus-castus</i>	Chaste tree	CT
<b>SHRUBS</b>		
<i>Adenostoma fasciculatum</i>	Chamise	AFSS, CH
<i>Amorpha fruticosa</i>	False indigobush	CLORF, CLOW, SRW
<i>Arctostaphylos glandulosa</i>	Eastwood manzanita	CH
<i>Arctostaphylos glauca</i>	Bigberry manzanita	AFSS, CH
<i>Artemisia californica</i>	California sagebrush	SH, AFSS, CSS, CH, CLORF, CLOW
<i>Atriplex canescens</i>	Four-wing saltbush	DS
<i>Atriplex lentiformis</i> ssp. <i>lentiformis</i>	Saltbush	SH, CSS, DM
<i>Baccharis pilularis</i> var. <i>consanguinea</i>	Coyote brush	SH, CSS, CLORF, CLOW, SRW, DM
<i>Baccharis salicifolia</i>	Mulefat	SH, CLORF, CWRF, SRW, PFEW
<i>Baccharis sarothroides</i>	Broom baccharis	DS
<i>Berberis nevii</i>	Nevin's barberry	SH, AFSS
<i>Berberis pinnata</i>	California barberry	CSS, CLORF, CLOW, SRW

- Coast Live Oak Woodland (CLOW) on page 262
- Southern Cottonwood-Willow Riparian Forest (CWRWF) on page 270
- Southern Sycamore Riparian Woodland (SRW) on page 276
- Valley Oak Woodland (VOW) on page 284

- California Walnut Woodland (CWW) on page 288
- Perennial Freshwater Emergent Wetland (PFEW) on page 294
- Dry Meadow (DM) on page 300
- Desert Scrub (DS) on page 306
- Climate Adapted Trees (CT) on page 312

BOTANICAL NAME	COMMON NAME	PLANT COMMUNITIES
<i>Brickellia californica</i>	California brick-lebush	AFSS
<i>Calliandra eriophylla</i>	Fairy duster	DS
<i>Ceanothus crassifolius</i>	Hoaryleaf ceanothus	AFSS, CH
<i>Ceanothus cuneatus</i>	Buck brush	CH
<i>Ceanothus leucodermis</i>	Chaparral whitethorn	AFSS, CH, CLOW
<i>Ceanothus megacarpus</i>	Big-pod ceanothus	CH
<i>Ceanothus oliganthus</i>	Hairy ceanothus	CH, CLORF, CLOW
<i>Ceanothus spinosus</i>	Greenbark ceanothus	CH
<i>Cercocarpus betuloides</i> var. <i>betuloides</i>	Mountain mahogany	SH, AFSS, CH
<i>Dendromecon rigida</i>	Bush poppy	AFSS, CSS, CH
<i>Diplacus longiflorus</i>	Southern bush monkey flower	CSS, CH
<i>Encelia actoni</i>	Acton brittlebush	DS
<i>Encelia californica</i>	Bush sunflower	SH, AFSS, CSS
<i>Encelia farinosa</i>	Brittlebush	DS
<i>Ephedra viridis</i>	Mountain ephedra	DS
<i>Ericameria (Happlopappus) pinifolia</i>	Pine goldenbush	AFSS, CSS
<i>Ericameria nauseosa</i>	Rabbitbrush	DS
<i>Eriodictyon crassifolium</i>	Thick-leaved yerba santa	AFSS, CSS
<i>Eriodictyon trichocalyx</i> var. <i>trichocalyx</i>	Hairy yerba santa	SH, AFSS
<i>Eriogonum cinereum</i>	Ashleaf buckwheat	SH, CSS, CH
<i>Eriogonum fasciculatum</i> var. <i>fasciculatum</i>	California buckwheat	AFSS, CSS, CLOW
<i>Eriogonum fasciculatum</i> var. <i>foliosum</i>	Leafy California buckwheat	SH, AFSS, CSS, CH, CLORF, CLOW, DS
<i>Eriogonum fasciculatum</i> var. <i>polifolium</i>	Interior California buckwheat	AFSS, CH, DS
<i>Fallugia paradoxa</i>	Apache plume	DS
<i>Frangula californica</i> ssp. <i>californica</i>	California coffeeberry	SH, CH, CLORF, CLOW, SRW, VOW, DS
<i>Gutierrezia californica</i>	California matchweed	AFSS
<i>Gutierrezia sarothrae</i>	Matchweed	AFSS
<i>Heteromeles arbutifolia</i>	Toyon	SH, CSS, CH, CLORF, CLOW, SRW, WW
<i>Hyptis emoryi</i>	Desert lavender	DS
<i>Isocoma menziesii</i> ssp. <i>vernonioides</i>	Goldenbush	CSS, CH, CLORF, CLOW, DM

BOTANICAL NAME	COMMON NAME	PLANT COMMUNITIES
<i>Isomeris arborea</i>	Bladder pod	DS
<i>Juniperus californica</i>	California juniper	AFSS
<i>Justicia californica</i>	Chuparosa	DS
<i>Keckiella cordifolia</i>	Heart-leaved penstemon	CSS, CH, CLORF, CLOW, SRW
<i>Larrea tridentata</i>	Creosote bush	DS
<i>Lepechinia fragrans</i>	Fragrant pitcher plant	CH, CLOW
<i>Lepidospartum squamatum</i>	Scale broom	AFSS
<i>Lonicera subspicata</i> var. <i>denudata</i>	Chaparral honeysuckle	CH, CLORF, WW
<i>Lupinus excubitus</i>	Grape soda lupine	DS
<i>Lycium andersonii</i>	Water jacket	DS
<i>Malacothamnus davidsonii</i>	Davidson's bush mallow	SH, AFSS
<i>Malacothamnus fasciculatus</i>	Chaparral bush mallow	AFSS, CSS, WW
<i>Malosma laurina</i>	Laurel sumac	SH, AFSS, CSS, CH, CLORF, CLOW, SRW
<i>Mimulus aurantiacus</i>	Bush monkey flower	SH, CSS, CH, CLORF, CLOW, SRW, WW
<i>Peritoma arborea</i>	Bladderpod	SH, CSS, DS
<i>Pluchea sericea</i>	Arrow weed	SH, AFSS, CSS, CWRWF, SRW
<i>Prosopis glandulosa</i>	Honey mesquite	DS
<i>Prunus ilicifolia</i> ssp. <i>ilicifolia</i>	Hollyleaf cherry	SH, AFSS, CSS, CH, CLORF, CLOW, SRW, WW
<i>Quercus berberidifolia</i>	Scrub oak	AFSS, CSS, CH
<i>Rhamnus crocea</i>	Spiny redberry	SH, AFSS, CSS, CH
<i>Rhamnus ilicifolia</i>	Hollyleaf redberry	SH, CSS, CH, CLORF, CLOW, SRW, WW
<i>Rhus aromatica</i>	Fragrant sumac	CH, CLORF, CLOW, CWRWF, SRW
<i>Rhus integrifolia</i>	Lemonadeberry	SH, AFSS, CSS, CH, CLORF, CLOW, SRW
<i>Rhus ovata</i>	Sugar bush	SH, AFSS, CH, CLOW, WW
<i>Ribes aureum</i> var. <i>gracilimum</i>	Golden currant	SH, CLORF, CLOW, SRW, WW
<i>Ribes californicum</i> var. <i>hesperium</i>	Hillside gooseberry	SH, CH, CLORF, CLOW, SRW
<i>Ribes malvaceum</i> var. <i>viridifolium</i>	Chaparral currant	CH, CLOW
<i>Ribes speciosum</i>	Fuchsia-flowered gooseberry	SH, CH, CLORF, CLOW, SRW
<i>Rosa californica</i>	California wild rose	SH, CLORF, CLOW, CWRWF, SRW

# PLANT SPECIES INDEX

BOTANICAL NAME	COMMON NAME	PLANT COMMUNITIES
<b>SHRUBS (continued)</b>		
<i>Salix exigua</i>	Sandbar willow	SH, CWRF, SRW, PFEW
<i>Salix lasiandra</i>	Shining willow	CWRF, PFEW
<i>Salix lasiolepis</i>	Arroyo willow	SH, CWRF, SRW, PFEW
<i>Salvia apiana</i>	White sage	SH, AFSS, CSS, CH, CLORF, CLOW, DS
<i>Salvia leucophylla</i>	Purple sage	SH, CSS, CLOW, WW
<i>Salvia mellifera</i>	Black sage	SH, AFSS, CSS, CH, CLOW, WW
<i>Scutellaria mexicana</i>	Mexican bladder-sage	DS
<i>Simmondsia chinensis</i>	Jojoba	DS
<i>Sphaeralcea ambigua</i>	Apricot mallow	DS
<i>Tecoma stans</i>	Yellow bells	DS
<i>Trichostema lanatum</i>	Woolly blue curls	CSS, CH
<i>Venegasia carpesioides</i>	Canyon sunflower	CLORF, CLOW, SRW
<b>PERENNIALS</b>		
<i>Abutilon palmeri</i>	Palmer's Indian mallow	DS
<i>Acourtia microcephala</i>	Sacapellote	CH
<i>Alisma triviale</i>	Water plantain	PFEW
<i>Ambrosia psilostachya</i>	Western ragweed	DM
<i>Artemisia douglasiana</i>	Mugwort	SH, CLORF, CLOW, CWRF, SRW, PFEW
<i>Asclepias eriocarpa</i>	Indian milkweed	CSS, CH, CLOW
<i>Asclepias erosa</i>	Desert milkweed	DS
<i>Asclepias fascicularis</i>	Narrow-leaved milkweed	CSS, CH, WW
<i>Bidens laevis</i>	Bur marigold	PFEW
<i>Bloomeria crocea</i>	Common golden-star	DM
<i>Corethrogyne filaginifolia</i> var. <i>filaginifolia</i>	California aster	SH, AFSS, CSS, CH, CLORF, CLOW, VOW, WW
<i>Croton californicus</i>	California croton	AFSS, CSS
<i>Delphinium cardinale</i>	Scarlet larkspur	AFSS, CSS, CH
<i>Dryopteris arguta</i>	Coastal wood fern	CLORF, CLOW, WW
<i>Epilobium canum</i> ssp. <i>canum</i>	Hoary California fuchsia	SH, CSS, CH, DM
<i>Epilobium canum</i> ssp. <i>latifolium</i>	California fuchsia	SH, CSS, CH, CLOW
<i>Equisetum hymale</i>	Scouring rush	PFEW
<i>Eriastrum densifolium</i> ssp. <i>elongatum</i>	Woolly star	AFSS
<i>Eriogonum elongatum</i>	Longstem buck-wheat	CH
<i>Eriophyllum confertiflorum</i>	Golden yarrow	AFSS, CSS, CH, CLORF, CLOW, CWRF, SRW, VOW, WW
<i>Eschscholzia californica</i>	California poppy	AFSS, CSS, CLOW, SRW, VOW, WW, DM

BOTANICAL NAME	COMMON NAME	PLANT COMMUNITIES
<i>Galium angustifolium</i>	Narrow-leaf bed-straw	AFSS
<i>Grindelia camporum</i>	Great valley gum-weed	DM
<i>Juncus patens</i>	California grey rush	SH, CLORF, CWRF, SRW
<i>Juncus textilis</i>	Basket rush	SRW
<i>Juncus torreyi</i>	Rush	CLORF, CWRF, SRW
<i>Linanthus californicus</i>	Prickly phlox	CSS, CLOW
<i>Lotus scoparius</i> ( <i>Acmispon glaber</i> )	Deerweed	AFSS, CSS, CH, CLORF, CLOW, SRW
<i>Lupinus bicolor</i>	Miniature lupine	DM
<i>Lupinus latifolius</i> var. <i>parishii</i>	Broad-leaf canyon lupine	CSS, CLORF, CLOW, SRW
<i>Lupinus longifolius</i>	Blue bush lupine	CH
<i>Malacothrix saxatilis</i>	Cliff aster	CSS, WW
<i>Mimulus cardinalis</i>	Scarlet monkey flower	CWRF
<i>Mirabilis californica</i> ( <i>Mirabilis laevis</i> )	Wishbone bush	AFSS, CSS
<i>Pellaea andromedifolia</i>	Coffee fern	AFSS, CSS
<i>Pellaea mucronata</i>	Bird's foot fern	AFSS, CSS
<i>Penstemon centranthifolius</i>	Scarlet bugler	SH, CH, CLOW
<i>Penstemon heterophyllus</i> var. <i>australis</i>	Foothill penstemon	SH, CH, CLOW, DM
<i>Penstemon spectabilis</i>	Showy penstemon	SH, AFSS, CSS, CH, CLOW
<i>Polypodium californicum</i>	California polypody fern	AFSS, CSS
<i>Pseudognaphalium canescens</i>	Wright's cudweed	DM
<i>Romneya coulteri</i>	Coulter's Matilija poppy	CSS, CH, DS
<i>Sidalcea malviflora</i>	Checker bloom	DM
<i>Sisyrinchium bellum</i>	Blue-eyed grass	CSS, CLOW, VOW, WW, DM
<i>Solanum xanti</i>	Purple or chaparral nightshade	AFSS, CSS, CH
<i>Sparganium eurycarpum</i>	Broadfruit bur-reed	PFEW
<i>Thalictrum fendleri</i> var. <i>polycarpum</i>	Meadow rue	CH, CLORF, CWRF, SRW, WW
<i>Typha domingensis</i>	Southern cattail	SRW
<i>Typha latifolia</i>	Broadleaf cattail	PFEW
<b>GRASSES</b>		
<i>Agrostis exarata</i>	Bent grass	CLORF, CWRF, SRW
<i>Agrostis pallens</i>	Seashore bent grass	DM
<i>Aristida purpurea</i>	Purple three awn	SH, DS
<i>Bolboschoenus maritimus</i>	Alkali bulrush	PFEW
<i>Bothriochloa barbinodis</i>	Cane bluegrass	CH
<i>Bouteloua gracilis</i>	Blue grama	DS
<i>Bromus carinatus</i> var. <i>carinatus</i>	California brome	CSS, CH, CLORF, CLOW, SRW, VOW, WW, DM



BOTANICAL NAME	COMMON NAME	PLANT COMMUNITIES
<i>Carex barbarae</i>	Valley sedge	CWRF, SRW
<i>Carex fracta</i>	Fragile-sheathed sedge	PFEW
<i>Carex senta</i>	Swamp carex	PFEW
<i>Carex spissa</i>	San Diego sedge	CWRF, SRW, PFEW
<i>Cyperus eragrostis</i>	Tall flatsedge	PFEW
<i>Elymus condensatus</i>	Giant wildrye	SH, AFSS, CSS, CH, CLORF, CLOW, CWRF, SRW, VOW, WW
<i>Elymus elymoides</i> var. <i>elymoides</i>	Squirreltail	AFSS
<i>Elymus glaucus</i> ssp. <i>glaucus</i>	Blue wild rye	CSS, CH, CLORF, CLOW, WW, PFEW, DM
<i>Elymus trachycaulus</i>	Slender wheatgrass	DM
<i>Festuca californica</i>	California fescue	DM
<i>Hordeum brachyantherum</i> ssp. <i>californicum</i>	California meadow barley	DM
<i>Juncus balticus</i>	Wire rush	PFEW
<i>Juncus macrophyllus</i>	Long-leaved rush	PFEW
<i>Juncus xiphioides</i>	Iris-leaf rush	PFEW
<i>Koeleria macrantha</i>	Junegrass	CLOW, DM
<i>Melica californica</i>	California melic-grass	DM
<i>Muhlenbergia rigens</i>	Deergrass	SH, CH, CLORF, CLOW, SRW, VOW, DM
<i>Poa secunda</i> ssp. <i>secunda</i> ( <i>P. scabrella</i> )	One-sided blue-grass	CLOW
<i>Schoenoplectus acutus</i> var. <i>occidentalis</i>	Tule	SRW
<i>Schoenoplectus californicus</i>	California bulrush	PFEW
<i>Sporobolus airoides</i>	Alkali sacaton	SH, CSS, DM, DS
<i>Stipa cernua</i>	Nodding need-legrass	CH, CLOW, VOW, DM
<i>Stipa coronatum</i>	Giant stipa	AFSS, CSS, CH, DM
<i>Stipa hymenoides</i>	Indian ricegrass	DS
<i>Stipa lepida</i>	Foothill need-legrass	AFSS, CSS, CH, CLOW, WW, DM
<i>Stipa pulchra</i>	Purple needlegrass	CH, CLOW, VOW, WW, DM
<i>Stipa speciosa</i>	Desert needlegrass	AFSS, DS
<b>SUCCULENTS</b>		
<i>Agave deserti</i>	Desert agave	DS
<i>Cylindropuntia californica</i> var. <i>parkeri</i>	Cane cholla	AFSS
<i>Dudleya lanceolata</i>	Lance-leaved live-forever	AFSS, CSS
<i>Dudleya pulverulenta</i>	Chalk dudleya	CSS, CH
<i>Fouquieria splendens</i>	Ocotillo	DS
<i>Opuntia basilaris</i>	Beaver tail	AFSS, DS
<i>Opuntia littoralis</i>	Coastal prickly pear	AFSS, WW
<i>Yucca schidigera</i>	Mojave yucca	DS

BOTANICAL NAME	COMMON NAME	PLANT COMMUNITIES
<i>Yucca whipplei</i>	Our lord's candle / chaparral yucca	SH, AFSS, CSS, CH, CLOW
<b>VINES</b>		
<i>Calystegia macrostegia</i> ssp. <i>arida</i>	Southern California morning glory	SH, AFSS, CSS, WW
<i>Calystegia macrostegia</i> ssp. <i>intermedia</i>	Island morning glory	SH, WW
<i>Clematis lasiantha</i>	Pipestems	SH, CH, CLORF, CLOW
<i>Clematis ligusticifolia</i>	Virgin's bower	SH, AFSS, CSS, CH, CLORF, CLOW, CWRF, SRW, VOW, WW
<i>Funastrum cynanchoides</i> var. <i>hartwegii</i>	Twining milkweed	AFSS, CSS
<i>Lathyrus vestitus</i>	Pacific sweet pea	AFSS, CSS, CH, CLORF, CLOW, VOW
<i>Lathyrus vestitus</i> var. <i>alefeldii</i>	Showy Pacific sweet pea	AFSS, CSS, CH, CLOW
<i>Vitis girdiana</i>	Desert grape	SH, CLORF, CWRF, SRW, VOW, DS
<b>GROUNDCOVERS</b>		
<i>Achillea millefolium</i> var. <i>californicum</i>	Yarrow	SH, CLOW, VOW, WW, DM
<i>Anemopsis californica</i>	Yerba mansa	PFEW
<i>Carex praegracilis</i>	Slender sedge	SH, CSS, CLORF, CLOW, CWRF, SRW, VOW, WW, PFEW
<i>Elymus triticoides</i>	Creeping wild rye	SH, CLORF, CWRF, SRW, VOW, WW
<i>Euthamia occidentalis</i>	Western goldenrod	SH, AFSS, CSS, CWRF, SRW, VOW, WW
<i>Nasturtium officinale</i>	Watercress	PFEW
<i>Salvia spathacea</i>	Pitcher sage	SH, CH, CLORF, CLOW, SRW, DM
<i>Solidago californica</i>	California gold-enrod	SH, AFSS, CSS, CH, CLORF, CLOW, CWRF, SRW, VOW, WW
<i>Solidago confinis</i>	Southern gold-enrod	SH, AFSS, CSS, CH, CLORF, CLOW, CWRF, SRW, VOW, WW
<i>Stachys bullata</i>	Pink hedgenettle	SH, CLORF, CLOW, SRW
<i>Symphoricarpos mollis</i>	Creeping snow-berry	SH, CH, CLORF, CLOW, SRW, WW
<b>ANNUALS</b>		
<i>Achyraea mollis</i>	Blow wives	DM
<i>Ambrosia acanthicarpa</i>	Annual bursage	DM
<i>Apiastrum angustifolium</i>	Mock parsley	DM
<i>Camissoniopsis bistorta</i>	California sun cup	DM
<i>Chaenactis glabriuscula</i>	Yellow pincushion	DM
<i>Cryptantha intermedia</i>	Common crypt-antha	DM
<i>Deinandra fasciculata</i>	Clustered tarweed	DM
<i>Lasthenia californica</i>	California gold-fields	DM
<i>Layia platyglossa</i>	Coastal tidy tips	DM
<i>Phacelia stellaris</i>	Brand's star phacelia	DM
<i>Lepidium nitidum</i>	Peppergrass	DM

## SHORTLIST

**Shortlist (SH):** The shortlist of native LA River watershed plants can be used throughout all reaches of the river to provide overall landscape continuity. This list is much shorter than the plant community lists to ensure a strong visual image for the river, and is based upon the following criteria:

- Plants are native and appropriate to the LA River system.
- Plants are growable in nursery conditions.
- Plants have a high probability for success when planted within the designated area(s).
- Propagules of the plants are available within the LA River watershed.
- Plants have aesthetic appeal.
- Plants will provide potential wildlife habitat.
- Plants should require minimal maintenance and water following establishment when chosen carefully to be adapted to actual site conditions.

**Figure 172. *Platanus racemosa*.** Source: Raffi Kojian, <http://www.gardenology.org>, <https://commons.wikimedia.org/w/index.php?curid=9705655>.

**Figure 173. *Quercus agrifolia*.** Source: Stickpen, <https://commons.wikimedia.org/w/index.php?curid=9944130>.

**Figure 174. *Umbellularia californica*.** Source: Krzysztof Ziarnek, Kenraiz, <https://commons.wikimedia.org/w/index.php?curid=54448438>.

**Figure 175. *Frangula californica*.** Source: Krzysztof Ziarnek, Kenraiz, <https://commons.wikimedia.org/w/index.php?curid=37322426>.

**Figure 176. *Mimulus aurantiacus*.** Source: Franz Xaver, <https://commons.wikimedia.org/w/index.php?curid=17165632>.

**Figure 177. *Salvia mellifera*.** Source: Jerry Kirkhart, Black Sage, <https://commons.wikimedia.org/w/index.php?curid=43169351>.

**Figure 178. *Salvia spathacea*.** Source: peganum, <https://commons.wikimedia.org/w/index.php?curid=37049932>.

**Figure 179. *Solidago californica*.** Source: Stickpen, <https://commons.wikimedia.org/w/index.php?curid=8092464>.

**Figure 180. *Clematis ligusticifolia*.** Source: Stan Shebs, <https://commons.wikimedia.org/w/index.php?curid=5376939>.





*Platanus racemosa*



*Quercus agrifolia*



*Umbellularia californica*



*Frangula californica* ssp. *californica*



*Mimulus aurantiacus*



*Salvia mellifera*



*Salvia spathacea*



*Solidago californica*



*Clematis ligusticifolia*

**SPECIES**

**SITING + PERFORMANCE**

BOTANICAL NAME	COMMON NAME	SITING + PERFORMANCE				
		FRAMES FOR BEST PERFORMANCE	CONSTRUCTED CONTEXTS	APPLICATIONS	SUN EXPOSURE (FEET)	SETBACK FROM PAVEMENT
<b>TREES</b>						
<i>Alnus rhombifolia</i>	White alder	1-9	G	+ ^ ~ o	All	6
<i>Juglans californica</i> var. <i>californica</i>	California walnut	3-9	B, E, F	+ ^ !	FS / PS	6
<i>Platanus racemosa</i>	California sycamore	1-9	E, F	+ ^ ~	FS	6
<i>Populus fremontii</i> ssp. <i>fremontii</i>	Fremont cottonwood	1-9	F, G	+ ^ ~ o	FS	8
<i>Quercus agrifolia</i> var. <i>agrifolia</i>	Coast live oak	1-9	A, B, C	+ ^	FS	8
<i>Quercus lobata</i>	Valley oak	3-6	A, C, E	+ ^ *	FS	8
<i>Sambucus nigra</i> ssp. <i>caerulea</i>	Mexican elderberry	1-9	C, E, F	+ ^ ~ o	FS	6
<i>Umbellularia californica</i>	California bay laurel	1-9	B, E, F	+ ^ !	FS / PS	6
<b>SHRUBS AND PERENNIALS</b>						
<i>Artemisia californica</i>	California sagebrush	1-6, 9	A, C, D	* !	FS	3
<i>Artemisia douglasiana</i>	Mugwort	1-9	A, B, C, E	! ~ o	All	3
<i>Aristida purpurea</i>	Purple three awn	1-9	A, C, D, E	*	FS	1
<i>Atriplex lentiformis</i> ssp. <i>lentiformis</i>	Saltbush	1-5	C, D, E	* !	FS	5
<i>Baccharis pilularis</i> var. <i>consanguinea</i>	Coyote brush	1-5	A, C, D	* !	FS / PS	4
<i>Baccharis salicifolia</i>	Mulefat	1-9	F, G	+ ~ o	All	3
<i>Berberis nevini</i>	Nevin's barberry	3-9	A, C, E	+	FS	5
<i>Cercocarpus betuloides</i> var. <i>betuloides</i>	Mountain mahogany	1-9	B, C	+ ^ !	FS	6
<i>Corethrogyne filaginifolia</i> var. <i>filaginifolia</i>	California aster	1-9	A, B		FS	2
<i>Elymus condensatus</i>	Giant wildrye	1-9	A, B, C, E		All	2
<i>Encelia californica</i>	Bush sunflower	1-9	A, C	* !	FS / PS	3
<i>Epilobium canum</i> ssp. <i>canum</i>	Hoary California fuchsia	1-9	A, B	+	FS / PS	2
<i>Epilobium canum</i> ssp. <i>latifolium</i>	California fuchsia	1-9	A, B	+	FS / PS	2
<i>Eriodictyon trichocalyx</i> var. <i>trichocalyx</i>	Hairy yerba santa	5-9	A, C	+	FS	2
<i>Eriogonum cinereum</i>	Ashyleaf buckwheat	1-5	A, C	+	FS	3



## DESCRIPTIVE FEATURES

	PLANT FORM	WATER USE (WUCOLS IV)	MATURE HEIGHT (FEET)			MATURE WIDTH (FEET)			USACE NATIVE PLANT LIST	SEED LA TARGET LIST	OFTEN AVAILABLE IN CA	POLLINATOR HABITAT		BLOOM COLOR				BLOOM SEASON				PLANT COMMUNITIES
																W	SP	SU	F			
	T-D	H	20-30	20-30				X	Birds, Butterflies	Green / Cream				X	X						SRW	
	T-D	L	15-25	20	X			X	Birds	Yellow			X								CH, CLORF, CLOW, SRW, WW	
	T-D	M	40	40	X			X	Birds, Butterflies	Yellow/Cream	X	X									AFSS, CLORF, CWRF, SRW, VOW	
	T-D	M	30	35				X	Birds, Butterflies	Cream	X	X									CLORF, CWRF, SRW	
	T	VL / L	40	40	X			X	Birds, Butterflies	Yellow			X								AFSS, CLORF, CLOW, SRW, VOW, WW	
	T-D	M	35	35	X			X	Birds, Butterflies	Green / Cream	X	X									VOW	
	T-D	L	15	20	X			X	Birds, Butterflies, Bees	Yellow/Cream			X	X							AFSS, CLORF, CLOW, CSS, CWRF, SRW, WW	
	T	L	30	30				X	Birds	Yellow/Cream			X								AFSS, CLORF, CLOW, CSS, CWRF, SRW, WW	
	S	VL	3	2-3	X	X	X	X	Birds, Butterflies	White + Yellow			X	X	X						AFSS, CH, CLORF, CLOW, CSS, SRW	
	P	M	3-5	3+	X			X	Birds, Butterflies	Yellow/Cream			X	X	X						CLORF, CWRF, SRW	
	G/P/GC	VL	1-3	2				X													DS	
	S	VL	6-8	5-10	X			X	Birds, Butterflies	Yellow/Brown					X						CSS	
	S	L	4-6	6-8	X			X	Bees, Butterflies	Yellow/Cream	X	X	X	X							CLORF, CLOW, CSS, SRW	
	S	H	4-8	6-10	X			X	Bees, Butterflies	White/Pink/White	X	X	X	X							CH, CSS	
	S	VL	6-12	6-12				X	Birds, Bees	Yellow / Green			X								AFSS	
	T/S	VL	6-20	12				X	Birds	Yellow/Cream	X	X									AFSS, CH	
	P	L	1-3	1-3				X	Birds, Butterflies, Bees	Purple/Pink/White	X										AFSS, CH, CLORF, CLOW, CSS, VOW, WW	
	G/P/GC	L	4-5	3+				X	Butterflies												CH, CLORF, CLOW, CSS, CWRF, SRW, VOW, WW	
	S	VL	3-4	3-6	X			X	Birds, Butterflies, Bees	Yellow	X	X									AFSS, CSS	
	P	VL	1-3	2-4					Birds, Butterflies	Red					X	X					CH, CSS	
	P	VL	1-3	2-4				X	Birds, Butterflies	Red					X	X					CH, CLOW, CSS	
	S	VL	2-5	3+	X				Butterflies	White					X						AFSS	
	S	VL	2-4	3-5				X	Birds, Butterflies, Bees	Yellow/Brown	X	X	X	X							CH, CSS	

**SPECIES**

**SITING + PERFORMANCE**

BOTANICAL NAME	COMMON NAME	SITING + PERFORMANCE				
		FRAMES FOR BEST PERFORMANCE	CONSTRUCTED CONTEXTS	APPLICATIONS	SUN EXPOSURE (FEET)	SETBACK FROM PAVEMENT
<b>SHRUBS AND PERENNIALS (continued)</b>						
<i>Eriogonum fasciculatum</i> var. <i>foliolosum</i>	Leafy California buckwheat	1-9	A, C	+!	FS / PS	3
<i>Frangula californica</i> ssp. <i>californica</i>	California coffeeberry	1-9	A, B, C, D	*!	All	6
<i>Heteromeles arbutifolia</i>	Toyon	1-9	A, B, C, E, F	+^!	FS / PS	6
<i>Juncus patens</i>	California grey rush	1-9	E, F, G	~o	FS / PS	2
<i>Malacothamnus davidsonii</i>	Davidson's bush mallow	6-9	A, C, D	+	FS	8
<i>Malosma laurina</i>	Laurel sumac	1-9	A, C	+!	FS	6
<i>Mimulus aurantiacus</i>	Bush monkey flower	1-9	A, B, C		FS / PS	2
<i>Muhlenbergia rigens</i>	Deergrass	1-9	A, B, C, E, F		FS / PS	3
<i>Penstemon centranthifolius</i>	Scarlet bugler	1-9	A, B, C, E, F	+	FS	2
<i>Penstemon heterophyllus</i> var. <i>australis</i>	Foothill penstemon	1-3; 6-9	A, B, C		FS / PS	1
<i>Penstemon spectabilis</i>	Showy penstemon	1-9	C		FS	1
<i>Peritoma arborea</i>	Bladderpod	1-9	A, B, C	+!	FS / PS	4
<i>Pluchea sericea</i>	Arrow weed	1-9	F, G	o	FS	3
<i>Prunus ilicifolia</i> ssp. <i>ilicifolia</i>	Hollyleaf cherry	5-9	A, B, C	+!	FS / PS	4
<i>Rhamnus crocea</i>	Spiny redberry	5-9	A, B, C	+!	All	4
<i>Rhamnus ilicifolia</i>	Hollyleaf redberry	5-9	A, B, C	+!	All	5
<i>Rhus integrifolia</i>	Lemonadeberry	1-9	A, B, C	+!	FS / PS	6
<i>Rhus ovata</i>	Sugar bush	1-9	A, C	+*!	FS / PS	6
<i>Ribes aureum</i> var. <i>gracillimum</i>	Golden currant	3-9	A, B, C, E, F		FS / PS	3
<i>Ribes californicum</i> var. <i>hesperium</i>	Hillside gooseberry	3-9	B, F, G	+	PS	4
<i>Ribes speciosum</i>	Fuchsia-flowered gooseberry	3-9	B, F	+	PS / FS	4
<i>Rosa californica</i>	California wild rose	1-9	E, F, G		All	3



## DESCRIPTIVE FEATURES

	PLANT FORM	WATER USE (WUCOLS IV)	MATURE HEIGHT (FEET)		MATURE WIDTH (FEET)		USAGE NATIVE PLANT LIST	SEED LA TARGET LIST	OFTEN AVAILABLE IN CA	POLLINATOR HABITAT	BLOOM COLOR				BLOOM SEASON	PLANT COMMUNITIES
			W	SP	SU	F										
	S	VL	3-5	2-6	X	X	X	Birds, Butterflies, Bees	Red/Cream			X			AFSS, CH, CLORF, CLOW, CSS	
	S	VL	8	12			X	Birds, Butterflies, Bees	Cream		X	X			CH, CLORF, CLOW, SRW, VOW	
	S/T	VL	8-15	15			X	Birds, Bees	White			X		CH, CLORF, CLOW, CSS, SRW, WW		
	P/GC	L	2.5	3+			X							CLORF, CWRF, SRW		
	S	(Not Listed)	10	8				Birds, Butterflies	Pink		X	X			AFSS	
	S	VL	10	20	X		X	Birds	Cream	X	X				AFSS, CH, CLORF, CLOW, CSS, SRW	
	S	VL	2	2		X	X	Birds, Butterflies, Bees	Orange/Yellow	X	X	X			CH, CLORF, CLOW, CSS, SRW, WW	
	G/P/GC	L	3	4			X	Birds							CH, CLORF, CLOW, SRW, VOW	
	P	L	1	1-2			X	Birds, Butterflies, Bees	Red		X	X			CH, CLOW	
	P	L	1	2			X	Birds, Butterflies, Bees	Purple/Blue	X	X	X			CH, CLOW	
	P	L	3	3			X	Birds	Purple/Blue/Pink	X					AFSS, CSS, CH, CLOW	
	S	VL	3-5	5	X		X	Birds, Butterflies, Bees	Yellow/Green	X	X				CLOW, CSS	
	S	M	6-8	6+			X		Pink		X	X			AFSS, CSS, CWRF, SRW	
	S	VL	6-12	6-12			X	Birds, Butterflies, Bees	Cream	X	X				AFSS, CH, CLORF, CLOW, CSS, SRW, WW	
	S	VL	4	4			X	Birds, Butterflies, Bees	Yellow/Cream	X	X				AFSS, CH, CSS	
	S	VL	6	6			X	Birds, Butterflies, Bees	Yellow/Cream	X	X				CH, CLORF, CLOW, CSS, SRW	
	S	VL	8-10	15	X		X	Birds	Pink	X	X				AFSS, CH, CLORF, CLOW, CSS, SRW	
	S	VL	8-10	15	X		X	Birds	Pink/White	X	X				AFSS, CH, CLOW, WW	
	S-D	VL	6-8	6-8	X	X	X	Birds, Butterflies, Bees	Yellow/Cream	X	X				CLORF, CLOW, SRW, WW	
	S-D	L	5	5-8	X		X	Birds, Butterflies, Bees	Purple/Yellow	X	X				CH, CLORF, CLOW, SRW	
	S-D	VL	5-8	6-8	X		X	Birds, Butterflies, Bees	Red/Pink	X	X				CH, CLORF, CLOW, SRW	
	S	L	4-6	4+			X	Birds, Butterflies, Bees	Pink		X	X			CLORF, CLOW, CWRF, SRW	

**SPECIES**

**SITING + PERFORMANCE**

BOTANICAL NAME		COMMON NAME	FRAMES FOR BEST PERFORMANCE	CONSTRUCTED CONTEXTS	APPLICATIONS	SUN EXPOSURE	SETBACK FROM PAVEMENT (FEET)
<b>SHRUBS AND PERENNIALS (continued)</b>							
<i>Salix exigua</i>		Sandbar willow	2-9	F, G	+ ~ o	FS	6
<i>Salix lasiolepis</i>		Arroyo willow	1-9	G	+ ^ ~ o	FS / PS	5
<i>Salvia apiana</i>		White sage	3-9	A, C, D	+ !	FS	3
<i>Salvia leucophylla</i>		Purple sage	1-9	A, C, D	+ * !	FS	5
<i>Salvia mellifera</i>		Black sage	1-9	A, C, D	+ !	FS	4
<i>Sporobolus airoides</i>		Alkali sacaton	1-5	A, C, D	*	FS	2
<i>Yucca whipplei</i>		Our Lord's candle / chaparral yucca	5-9	A, C	+ *	FS	5
<b>GROUNDCOVERS</b>							
<i>Achillea millefolium var. californicum</i>		Yarrow	1-9	A, B, C, D, E, F	!	FS / PS	1
<i>Carex praegracilis</i>		Slender sedge	1-9	D, E, F, G	o	FS / PS	1
<i>Elymus triticoides</i>		Creeping wild rye	1-9	B, E, F, G	!	All	2
<i>Euthamia occidentalis</i>		Western goldenrod	3-9	E, F, G	o	FS / PS	1
<i>Salvia spathacea</i>		Hummingbird sage	1-9	B, C, E		PS / FS	2
<i>Solidago californica</i>		California goldenrod	3-9	A, B, F, G	o	FS / PS	1
<i>Solidago confinis</i>		Southern goldenrod	3-9	E, F, G	o	FS / PS	1
<i>Stachys bullata</i>		Pink hedgenettle	1-9	E, F, G	+ ~ o	PS / FS	2
<i>Symphoricarpos mollis</i>		Creeping snowberry	3-9	B, E	!	PS / FS	2
<b>VINES</b>							
<i>Calystegia macrostegia ssp. arida</i>		Southern California morning glory	3-9	B		FS / PS	1
<i>Calystegia macrostegia ssp. intermedia</i>		Island morning glory	1-5	A, B		FS / PS	1
<i>Clematis lasiantha</i>		Pipestems	3-9	A, B		FS / PS	2
<i>Clematis ligusticifolia</i>		Virgin's bower	3-9	B, E, F, G	o	FS / PS	2
<i>Vitis girdiana</i>		Desert grape	3-9	G	o	All	2

## DESCRIPTIVE FEATURES

PLANT FORM	WATER USE (WUCOLS IV)	MATURE HEIGHT (FEET)		MATURE WIDTH (FEET)		USAGE NATIVE PLANT LIST	SEED LA TARGET LIST	OFTEN AVAILABLE IN CA	POLLINATOR HABITAT			BLOOM COLOR	BLOOM SEASON				PLANT COMMUNITIES
									W	SP	SU		F				
S-D	H	10-25	10-12	X		X	Birds, Butterflies, Bees		Yellow	X	X					CWRF, PFEW	
S/T-D	H	15	15			X	Birds, Butterflies, Bees		Cream	X	X					CWRF	
S	VL	3	3-5	X		X	Birds, Butterflies, Bees		White	X	X	X				AFSS, CH, CLORF, CLOW, CSS, SRW	
S	VL	5	6-8	X		X	Birds, Butterflies, Bees		Lavender/Purple		X	X				CLOW, CSS, WW	
S	VL	4	6	X	X	X	Birds, Butterflies, Bees		Lavender/White	X	X	X				AFSS, CH, CLOW, CSS	
G/P	L	3-4	2			X	Butterflies									DS	
SC	(Not Listed)	3	5		X	X	Birds		Cream		X					AFSS, CH, CLOW, CSS	
P/GC	L	.5-2	3	X		X	Birds, Butterflies, Bees		White		X	X				CLOW, VOW, WW	
P/GC	M	.5-1	2+			X										CLORF, CLOW, CSS, CWRF, SRW, VOW, WW	
G/P/GC	L	2	2+			X	Butterflies									CLORF, CWRF, SRW, VOW, WW	
P/GC	L	2-4	2+			X			Yellow/Green			X	X			AFSS, CSS, CWRF, SRW, VOW, WW	
P/GC	L	1	3+			X	Birds, Butterflies, Bees		Red/Pink	X	X	X				CH, CLORF, CLOW, SRW	
P/GC	M	1	2+			X	Bees, Butterflies		Yellow			X	X			AFSS, CH, CLORF, CLOW, CSS, CWRF, SRW, VOW, WW	
P/GC	M	1	2+				Bees		Yellow		X	X	X			AFSS, CH, CLORF, CLOW, CSS, CWRF, SRW, VOW, WW	
P/GC	L	1-2	2+	X		X	Birds, Butterflies, Bees		Lavender/Purple		X	X	X			CLORF, SRW	
S-D/GC	L	2	2+			X	Birds, Butterflies, Bees		Pink		X	X				CH, CLORF, CLOW, CWRF, SRW, WW	
V/P	L	climbs		X			Bees		White	X	X	X				AFSS, WW	
V/P	L	climbs		X	X		Bees		Pink/White	X	X	X				CSS, WW	
V-D	VL	climbs				X			Cream		X	X				CH, CLORF, CLOW	
V-D	L	climbs				X			Cream			X				AFSS, CH, CLORF, CLOW, CSS, CWRF, SRW, VOW, WW	
V/S-D	L	climbs				X	Birds		Green		X					CLORF, CWRF, SRW, VOW	

## ALLUVIAL FAN SAGE SCRUB

### Alluvial fan sage scrub (AFSS) (Scalebroom Association):

This community is found in rarely flooded, low-gradient deposits along streams. AFSS is a community that tolerates very dry conditions and is considered a 'disturbance' community. Alluvial fan sage scrub should be the signature community along the Tujunga Wash and is appropriate on particularly sandy, silty, or gravelly soils.

- Very rare in LA River watershed due to channelization and urbanization.
- Typically found in stream beds or washes.
- Can tolerate periodic flooding.

Figure 181. *Sambucus nigra ssp. caerulea*. Source: Stan Shebs, <https://commons.wikimedia.org/w/index.php?curid=1953423>.

Figure 182. *Lepidospartum squamatum*. Source: Anthony Valois and the National Park Service, [http://researchlearningcenter.org/bloom/species/Lepidospartum\\_squamatum.htm](http://researchlearningcenter.org/bloom/species/Lepidospartum_squamatum.htm) and <https://commons.wikimedia.org/w/index.php?curid=6011633>.

Figure 183. *Artemisia californica*. Source: Daderot, <https://commons.wikimedia.org/w/index.php?curid=75807390>.

Figure 184. *Eriogonum fasciculatum var. fasciculatum*. Source: Dominic, <http://www.inaturalist.org/photos/2067855>.

Figure 185. *Eriodictyon trichocalyx*. Source: Jim Morefield, <https://www.inaturalist.org/photos/14141764>.

Figure 186. *Salvia apiana*. Source: Laura Camp, <https://www.flickr.com/photos/lauracamp/16355349843>.

Figure 187. *Cylindropuntia californica var. parkeri*. Source: Stan Spencer, [https://calphotos.berkeley.edu/cgi/img\\_query?enlarge=0000+0000+0409+1587](https://calphotos.berkeley.edu/cgi/img_query?enlarge=0000+0000+0409+1587).

Figure 188. *Croton californicus*. Source: Stan Shebs, <https://commons.wikimedia.org/w/index.php?curid=5915540>.

Figure 189. *Yucca whipplei*. Source: Stan Shebs, <https://commons.wikimedia.org/w/index.php?curid=2826038>.





*Sambucus nigra ssp. caerulea*



*Lepidospartum squamatum*



*Artemisia californica*



*Eriogonum fasciculatum var. fasciculatum*



*Eriodictyon trichocalyx*



*Salvia apiana*



*Cylindropuntia californica var. parkeri*



*Croton californicus*



*Yucca whipplei*

**SPECIES**

**SITING + PERFORMANCE**

BOTANICAL NAME	COMMON NAME	SITING + PERFORMANCE				
		FRAMES FOR BEST PERFORMANCE	CONSTRUCTED CONTEXTS	APPLICATIONS	SUN EXPOSURE	SETBACK FROM PAVEMENT (FEET)
<b>TREES</b>						
<i>Platanus racemosa</i>	California sycamore	1-9	E, F	+ ^ ~ o	FS	6
<i>Quercus agrifolia</i> var. <i>agrifolia</i>	Coast live oak	1-9	A, B, C	+ ^	FS	8
<i>Sambucus nigra</i> ssp. <i>caerulea</i>	Mexican elderberry	1-9	C, E, F	+ ^ ~ o	FS	6
<b>SHRUBS</b>						
<i>Adenostoma fasciculatum</i>	Chamise	3-6, 9	A, C, D	* !	FS	4
<i>Arctostaphylos glauca</i>	Bigberry manzanita	5-9	B	+	FS	6
<i>Artemisia californica</i>	California sagebrush	1-6, 9	A, C, D	* !	FS	3
<i>Berberis nevii</i>	Nevin's barberry	3-9	A, C, E	+	FS	5
<i>Brickellia californica</i>	California bricklebrush	5-9	B, C		FS / PS	3
<i>Ceanothus crassifolius</i>	Hoaryleaf ceanothus	1-9	A, B, C	+ !	FS	6
<i>Ceanothus leucodermis</i>	Chaparral whitethorn	6-9	B, C	!	FS / PS	6
<i>Cercocarpus betuloides</i> var. <i>betuloides</i>	Mountain mahogany	1-9	B, C	+ !	FS	6
<i>Dendromecon rigida</i>	Bush poppy	1-6, 9	A, C		FS	5
<i>Encelia californica</i>	Bush sunflower	1-9	A, C	* !	FS / PS	3
<i>Ericameria (Happlopappus) pinifolia</i>	Pine goldenbush	5-9	A, C		FS	3
<i>Eriodictyon crassifolium</i>	Thick-leaved yerba santa	1-9	A, C	+	FS	2
<i>Eriodictyon trichocalyx</i> var. <i>trichocalyx</i>	Hairy yerba santa	5-9	A, C	+	FS	2
<i>Eriogonum fasciculatum</i> var. <i>fasciculatum</i>	California buckwheat	1-6, 9	A		FS / PS	4
<i>Eriogonum fasciculatum</i> var. <i>foliolosum</i>	Leafy California buckwheat	1-9	A, C	+ !	FS / PS	3
<i>Eriogonum fasciculatum</i> var. <i>polifolium</i>	Interior California buckwheat	3-9	A, C	+ * !	FS / PS	3
<i>Gutierrezia californica</i>	California matchweed	3-9	A, C		FS	2
<i>Gutierrezia sarothrae</i>	Matchweed	1-6, 9	A, C, D	*	FS	2
<i>Juniperus californica</i>	California juniper	6-9	A, C	!	FS	6
<i>Lepidospartum squamatum</i>	Scale broom	1-9	C, E	+	FS	4
<i>Malacothamnus davidsonii</i>	Davidson's bush mallow	6-9	A, C, D	+	FS	8
<i>Malacothamnus fasciculatus</i>	Chaparral bush mallow	1-9	A	+ !	FS	4
<i>Malosma laurina</i>	Laurel sumac	1-9	A, C	+ !	FS	6



## DESCRIPTIVE FEATURES

	PLANT FORM	WATER USE (WUCOLS IV)	MATURE HEIGHT (FEET)		MATURE WIDTH (FEET)		SHORTLIST PLANT	USACE NATIVE PLANT LIST	SEED LA TARGET LIST	OCCURRENCE IN COMMUNITY	OFTEN AVAILABLE IN CA	POLLINATOR HABITAT	BLOOM COLOR				BLOOM SEASON			
			W	SP	SU	F														
T-D	M		40	40	X	X		Occasional	X	Birds, Butterflies	Yellow/Cream	X	X							
T	VL / L		40	40	X	X		Occasional	X	Birds, Butterflies	Yellow		X							
T-D	L		15	20	X	X		Occasional	X	Birds, Butterflies, Bees	Yellow/Cream		X	X						
S	VL		4-8	6	X			Occasional	X	Birds, Butterflies, Bees	White		X	X						
T/S	VL		6-15	6-15				Occasional		Birds, Bees	White + Pink	X	X							
S	VL		3	2-3	X	X	X	Frequent - Occasional	X	Birds, Butterflies	White + Yellow		X	X	X					
S	VL		6-12	6-12			X	Birds, Bees	X	Birds, Bees	Yellow / Green		X							
S	VL / L		2-4	3-5		X		Frequent - Occasional	X	Butterflies	Yellow			X	X					
S	(Not Listed)		6-15	8-20				Occasional	X	Birds, Butterflies, Bees	White	X	X							
S	VL		10-12	10-20				Occasional		Birds, Butterflies, Bees	Blue/Purple +White	X	X							
T/S	VL		6-20	12	X			Occasional	X	Birds	Yellow/Cream	X	X							
S	VL		8-12	10-15				Occasional	X	Bees, Butterflies	Yellow	X	X							
S	VL		3-4	3-6	X	X		Frequent - Occasional	X	Birds, Butterflies, Bees	Yellow	X	X							
S	(Not Listed)		3-6	3-6		X		Frequent - Occasional		Birds	Yellow		X	X						
S	VL		3-6	3+				Occasional	X	Birds, Butterflies, Bees	Lavender		X							
S	VL		2-5	3+	X	X		Frequent		Butterflies	White			X						
S/GC	VL		3	2-6		X		Subdominant		Bees, Butterflies	Red/Cream			X						
S	VL		3-5	2-6	X	X	X	Occasional	X	Birds, Butterflies, Bees	Red/Cream			X						
S	VL		3-5	2-6				Subdominant	X	Birds, Butterflies, Bees	Pink/Cream			X						
S	(Not Listed)		1-3	1-3		X		Frequent - Occasional	X	Bees	Yellow		X	X	X					
S	VL		1-3	1-3				Frequent - Occasional	X	Bees	Yellow			X						
T/S	VL		10-15	15-20				Frequent - Occasional	X											
S	(Not Listed)		4	6		X		Dominant	X		Cream			X	X					
S	(Not Listed)		10	8	X			Occasional		Birds, Butterflies	Pink		X	X						
S	VL		6	6+		X		Occasional	X	Birds, Butterflies	White + Pink		X	X						
S	VL		10	20	X	X		Occasional	X	Birds	Cream	X	X							

**SPECIES**

**SITING + PERFORMANCE**

BOTANICAL NAME	COMMON NAME	SITING + PERFORMANCE				
		FRAMES FOR BEST PERFORMANCE	CONSTRUCTED CONTEXTS	APPLICATIONS	SUN EXPOSURE	SETBACK FROM PAVEMENT (FEET)
<b>SHRUBS (continued)</b>						
<i>Pluchea sericea</i>	Arrow weed	1-9	F, G	o	FS	3
<i>Prunus ilicifolia</i> ssp. <i>ilicifolia</i>	Hollyleaf cherry	5-9	A, B, C	+!	FS / PS	4
<i>Quercus berberidifolia</i>	Scrub oak	1-9	A, B, C	+!	FS	6
<i>Rhamnus crocea</i>	Spiny redberry	5-9	A, B, C	+!	All	4
<i>Rhus integrifolia</i>	Lemonadeberry	1-9	A, B, C	+!	FS / PS	6
<i>Rhus ovata</i>	Sugar bush	1-9	A, C	+*!	FS / PS	6
<i>Salvia apiana</i>	White sage	3-9	A, C, D	+!	FS	3
<i>Salvia mellifera</i>	Black sage	1-9	A, C, D	+!	FS	4
<b>PERENNIALS</b>						
<i>Corethrogyne filaginifolia</i> var. <i>filaginifolia</i>	California aster	1-9	A, B		FS	2
<i>Croton californicus</i>	California croton	1-9	C, E	*	FS	1
<i>Delphinium cardinale</i>	Scarlet larkspur	1-6, 9	A		FS	2
<i>Eriastrum densifolium</i> ssp. <i>elongatum</i>	Woolly star	6-9	C, E		FS	1
<i>Eriophyllum confertiflorum</i>	Golden yarrow	1-9	A, B, C	+	FS / PS	1
<i>Eschscholzia californica</i>	California poppy	1-9	C, D		FS / PS	1
<i>Galium angustifolium</i>	Narrow-leaf bedstraw	1-9	A, C		FS / PS	1
<i>Lotus scoparius</i> ( <i>Acmispon glaber</i> )	Deerweed	1-6, 9	A, C	+*	FS	2
<i>Mirabilis californica</i> ( <i>Mirabilis laevis</i> )	Wishbone bush	1-9	A, C, D	*	FS	2
<i>Pellaea andromedifolia</i>	Coffee fern	3-9	C, E		PS	1
<i>Pellaea mucronata</i>	Bird's foot fern	3-9	C, E	*	PS	1
<i>Penstemon spectabilis</i>	Showy penstemon	1-9	C		FS	2
<i>Polypodium californicum</i>	California polypody fern	6-9	B, G		PS / FS	1
<i>Solanum xanti</i>	Purple or chaparral nightshade	1-9	A, C		FS / PS	2
<b>GRASSES</b>						
<i>Elymus condensatus</i>	Giant wild rye	1-9	A, B, C, E		All	2
<i>Elymus elymoides</i> var. <i>elymoides</i>	Squirreltail	6-9	C, E		FS	1
<i>Stipa coronatum</i>	Giant stipa	1-9	A, E, F		FS / PS	2
<i>Stipa lepida</i>	Foothill needlegrass	1-9	A, B, C, D		FS / PS	1
<i>Stipa speciosa</i>	Desert needlegrass	3-9	A, C, D, E	*	FS	1

## DESCRIPTIVE FEATURES

PLANT FORM	WATER USE (WUCOLS IV)	MATURE HEIGHT (FEET)			MATURE WIDTH (FEET)			SHORTLIST PLANT	USACE NATIVE PLANT LIST	SEED LA TARGET LIST	OCCURRENCE IN COMMUNITY	OFTEN AVAILABLE IN CA	POLLINATOR HABITAT	BLOOM COLOR				BLOOM SEASON			
		6-8	6+	X														W	SP	SU	F
S	M	6-8	6+	X				Occasional	X				Pink		X	X					
S	VL	6-12	6-12	X				Occasional	X	Birds, Butterflies, Bees			Cream	X	X						
T/S	VL	8	8		X			Occasional	X	Birds, Butterflies			Cream	X	X						
S	VL	4	4	X				Occasional	X	Birds, Butterflies, Bees			Yellow/Cream	X	X						
S	VL	8-10	15	X	X			Occasional	X	Birds			Pink	X	X						
S	VL	8-10	15	X	X			Occasional	X	Birds			Pink/White	X	X						
S	VL	3	3-5	X	X			Frequent	X	Birds, Butterflies, Bees			White	X	X	X					
S	VL	4	6	X	X	X		Occasional	X	Birds, Butterflies, Bees			Lavender/White	X	X	X					
P	L	1-3	1-3	X				Frequent - Occasional	X	Birds, Butterflies, Bees			Purple/Pink/White	X							
P	(Not Listed)	.5-1.5	.5-2		X			Frequent	X				Green		X	X					
P-D	(Not Listed)	2-6	1	X				Occasional		Birds			Red/Yellow			X					
P	VL	1-2	1-2					Frequent					Lavender			X					
P	VL	2	1-3			X		Frequent - Occasional	X	Bees, Butterflies			Yellow		X	X	X				
A/P-D	VL	1	1-2		X			Occasional	X	Birds, Butterflies, Bees			Orange / Yellow		X						
P	(Not Listed)	1-2	1-2					Frequent					Cream		X	X					
P	VL	3	3		X			Frequent - Occasional	X	Bees, Butterflies			Yellow	X	X	X					
P-D	VL	1	3					Frequent - Occasional	X				Purple/White	X	X						
P	VL	1	2		X			Occasional													
P	VL	1	2		X			Occasional													
P	L	3	3					Occasional	X	Birds			Purple/Blue/Pink	X							
P-D/GC	VL	.5	1+					Occasional	X												
P-D	VL	2	3					Occasional	X				Purple/Blue	X	X	X					
G/P/GC	L	4-5	3+	X				Occasional	X	Butterflies											
G/P/GC	(Not Listed)	1-2	1-2					Occasional													
G/P/GC	(Not Listed)	2-4	1-2					Occasional	X												
G/P/GC	VL	2	2		X			Frequent - Occasional	X												
G/P/GC	(Not Listed)	1-2	1					Occasional													

**SPECIES**

**SITING + PERFORMANCE**

SPECIES		SITING + PERFORMANCE					
BOTANICAL NAME	COMMON NAME	FRAMES FOR BEST PERFORMANCE	CONSTRUCTED CONTEXTS	APPLICATIONS	SUN EXPOSURE	SETBACK FROM PAVEMENT (FEET)	
<b>SUCCULENTS</b>							
<i>Cylindropuntia californica</i> var. <i>parkeri</i>	Cane cholla	5-7	A, C	*	FS	4	
<i>Dudleya lanceolata</i>	Lance-leaved live-forever	1-9	A		FS / PS	1	
<i>Opuntia basilaris</i>	Beaver tail	3-5, 9	A, C	*	FS	2	
<i>Opuntia littoralis</i>	Coastal prickly pear	1-9	A		FS	3	
<i>Yucca whipplei</i>	Our lord's candle / chaparral yucca	5-9	A, C	+*	FS	5	
<b>VINES</b>							
<i>Calystegia macrostegia</i> ssp. <i>arida</i>	Southern California morning glory	3-9	B		FS / PS	1	
<i>Clematis ligusticifolia</i>	Virgin's bower	3-9	B, E, F, G	o	FS / PS	2	
<i>Funastrum cynanchoides</i> var. <i>hartwegii</i>	Twining milkweed	6-9	B, E	*	FS / PS	2	
<i>Lathyrus vestitus</i>	Pacific sweet pea	6-9	B		FS / PS	2	
<i>Lathyrus vestitus</i> var. <i>alefeldii</i>	Showy Pacific sweet pea	6-9	B		FS / PS	2	
<b>GROUNDCOVERS</b>							
<i>Euthamia occidentalis</i>	Western goldenrod	3-9	E, F, G	o	FS / PS	1	
<i>Solidago californica</i>	California goldenrod	3-9	A, B, F, G	o	FS / PS	1	
<i>Solidago confinis</i>	Southern goldenrod	3-9	E, F, G	o	FS / PS	1	

## DESCRIPTIVE FEATURES

	PLANT FORM	WATER USE (WUCOLS IV)	MATURE HEIGHT (FEET)		MATURE WIDTH (FEET)	SHORTLIST PLANT USACE NATIVE PLANT LIST SEED LA TARGET LIST	OCCURRENCE IN COMMUNITY	OFTEN AVAILABLE IN CA	POLLINATOR HABITAT	BLOOM COLOR			BLOOM SEASON			
			W	SP	SU					F						
	SC	VL	4	4			Subdominant		Yellow / Green		X	X				
	SC	VL	1	1	X		Occasional	X	Birds, Butterflies	Orange / Pink		X	X			
	SC	VL	1-2	2			Occasional			Pink		X				
	SC	VL	3	3+	X		Frequent - Occasional	X	Birds	Orange / Yellow		X				
	SC	(Not Listed)	3	5	X	X	Frequent	X	Birds	Cream		X				
	V/P	L	climbs		X		Occasional		Bees	White	X	X	X			
	V-D	L	climbs		X		Occasional	X		Cream			X			
	V/S-D	L	climbs				Occasional		Butterflies	Maroon/White			X	X		
	V/P	(Not Listed)	climbs		X		Occasional	X		Pink/White	X	X				
	V/P	(Not Listed)	climbs				Occasional			Pink/Purple	X	X				
	P/GC	L	2-4	2+	X		Frequent - Occasional	X		Yellow / Green			X	X		
	P/GC	M	1	2+	X		Frequent - Occasional	X	Bees, Butterflies	Yellow			X	X		
	P/GC	M	1	2+	X		Frequent - Occasional		Bees	Yellow		X	X	X		

## COASTAL SAGE SCRUB

### Coastal sage scrub (CSS) (California Sagebrush Associations):

Coastal sage scrub (California Sagebrush Associations): This ecologically important community should be interspersed with tree communities along the length of the river, especially in situations where environmental or infrastructure conditions (utility corridors or other confined spaces) are not suitable for trees. CSS is an appropriate complement to the sycamore riparian and coast live oak communities and can be used with them as a transitional planting across an elevational difference or as a successional planting strategy prior to the maturation of tree canopies. Along the lower reaches of the river, this community may be augmented with coastal bluff species, and other salt tolerant native species adapted to heterogeneous soil conditions along the levees. Augmentation to this plant palette should be made only with the approval of a qualified botanist or ecologist.

- Many species can tolerate salt.
- Typically found on embankments and slopes.
- Can be used as a transitional planting prior to maturation of tree canopies in sycamore riparian and coast live oak woodland.

**Figure 190.** *Sambucus nigra ssp. caerulea*. Source: Stan Shebs, <https://commons.wikimedia.org/w/index.php?curid=1953423>.

**Figure 191.** *Baccharis pilularis var. consanguinea*. Source: Miguel Vieira, <https://commons.wikimedia.org/w/index.php?curid=9389145>.

**Figure 192.** *Artemisia californica*. Source: Daderot, <https://commons.wikimedia.org/w/index.php?curid=75807390>.

**Figure 193.** *Eriogonum fasciculatum var. fasciculatum*. Source: Dominic, <http://www.inaturalist.org/photos/2067855>.

**Figure 194.** *Isocoma menziesii ssp. vernonioides*. Source: Miguel Vieira, <https://commons.wikimedia.org/w/index.php?curid=9389145>.

**Figure 195.** *Epilobium canum ssp. canum*. Source: Krzysztof Ziarnek, Kenraiz, <https://commons.wikimedia.org/w/index.php?curid=54696863>.

**Figure 196.** *Corethrogyne filaginifolia var. filaginifolia*. Source: John Rusk, [https://www.flickr.com/photos/john\\_d\\_rusk/21207961929](https://www.flickr.com/photos/john_d_rusk/21207961929).

**Figure 197.** *Yucca whipplei*. Source: Stan Shebs, <https://commons.wikimedia.org/w/index.php?curid=2826038>.

**Figure 198.** *Stipa lepida*. Source: John Rusk, <https://commons.wikimedia.org/w/index.php?curid=59287600>.





*Sambucus nigra ssp. caerulea*



*Baccharis pilularis var. consanguinea*



*Artemisia californica*



*Eriogonum fasciculatum var. fasciculatum*



*Isocoma menziesii ssp. vernonioides*



*Epilobium canum ssp. canum*



*Corethrogyne filaginifolia var. filaginifolia*



*Yucca whipplei*



*Stipa lepida*

**SPECIES**

**SITING + PERFORMANCE**

BOTANICAL NAME	COMMON NAME	SITING + PERFORMANCE				
		FRAMES FOR BEST PERFORMANCE	CONSTRUCTED CONTEXTS	APPLICATIONS	SUN EXPOSURE	SETBACK FROM PAVEMENT (FEET)
<b>TREES</b>						
<i>Sambucus nigra ssp. caerulea</i>	Mexican elderberry	1-9	C, E, F	+ ^ ~ o	FS	6
<b>SHRUBS</b>						
<i>Artemisia californica</i>	California sagebrush	1-6, 9	A, C, D	* !	FS	3
<i>Atriplex lentiformis ssp. lentiformis</i>	Saltbush	1-5	C, D, E	* !	FS	5
<i>Baccharis pilularis var. consanguinea</i>	Coyote brush	1-5	A, C, D	* !	FS / PS	4
<i>Berberis pinnata</i>	California barberry	5-9	B, E, F	+ !	FS / PS	4
<i>Dendromecon rigida</i>	Bush poppy	1-6, 9	A, C		FS	5
<i>Diplacus longiflorus</i>	Southern bush monkey flower	1-9	A, B, C, D, E		FS / PS	3
<i>Encelia californica</i>	Bush sunflower	1-9	A, C	* !	FS / PS	3
<i>Ericameria (Happlopappus) pinifolia</i>	Pine goldenbush	5-9	A, C		FS	3
<i>Eriodictyon crassifolium</i>	Thick-leaved yerba santa	1-9	A, C	+	FS	2
<i>Eriogonum cinereum</i>	Ashleaf Buckwheat	1-5	A, C	+	FS	3
<i>Eriogonum fasciculatum var. fasciculatum</i>	California buckwheat	1-6, 9	A		FS / PS	4
<i>Eriogonum fasciculatum var. foliolosum</i>	Leafy California buckwheat	1-9	A, C	+ !	FS / PS	3
<i>Heteromeles arbutifolia</i>	Toyon	1-9	A, B, C, E, F	+ ^ !	FS / PS	6
<i>Isocoma menziesii ssp. vernonioides</i>	Goldenbush	1-9	A, C		FS / PS	2
<i>Keckiella cordifolia</i>	Heart-leaved penstemon	1-9	A, B, C, E		All	3
<i>Malacothamnus fasciculatus</i>	Chaparral bush mallow	1-9	A	+ !	FS	4
<i>Malosma laurina</i>	Laurel sumac	1-9	A, C	+ !	FS	6
<i>Mimulus aurantiacus</i>	Bush monkey flower	1-9	A, B, C		FS / PS	2
<i>Peritoma arborea</i>	Bladderpod	1-9	A, B, C	+ !	FS / PS	4
<i>Pluchea sericea</i>	Arrow weed	1-9	F, G	o	FS	3
<i>Prunus ilicifolia ssp. ilicifolia</i>	Hollyleaf cherry	5-9	A, B, C	+ !	FS / PS	4
<i>Quercus berberidifolia</i>	Scrub oak	1-9	A, B, C	+ !	FS	6
<i>Rhamnus crocea</i>	Spiny redberry	5-9	A, B, C	+ !	All	4
<i>Rhamnus ilicifolia</i>	Hollyleaf redberry	5-9	A, B, C	+ !	All	5
<i>Rhus integrifolia</i>	Lemonadeberry	1-9	A, B, C	+ !	FS / PS	6
<i>Salvia apiana</i>	White sage	3-9	A, C, D	+ !	FS	3



## DESCRIPTIVE FEATURES

	PLANT FORM	WATER USE (WUCOLS IV)	MATURE HEIGHT (FEET)			MATURE WIDTH (FEET)			SHORTLIST PLANT	USACE NATIVE PLANT LIST	SEED LA TARGET LIST	OCCURRENCE IN COMMUNITY	OFTEN AVAILABLE IN CA	POLLINATOR HABITAT	BLOOM COLOR				BLOOM SEASON			
			W	SP	SU	F	W	SP							SU	F						
	T-D	L	15	20	X	X			Frequent - Occasional	X	Birds, Butterflies, Bees	Yellow/Cream		X	X							
	S	VL	3	2-3	X	X	X		Dominant	X	Birds, Butterflies	White + Yellow		X	X	X						
	S	VL	6-8	5-10	X	X			Occasional	X	Birds, Butterflies	Yellow/Brown			X							
	S	L	4-6	6-8	X	X			Subdominant	X	Bees, Butterflies	Yellow/Cream	X	X	X	X						
	S	L	4-6	4+					Occasional	X	Birds, Butterflies, Bees	Yellow	X	X								
	S	VL	8-12	10-15					Occasional	X	Bees, Butterflies	Yellow	X	X								
	S	(Not Listed)	1-3	1-3					Occasional		Bees, Butterflies	Yellow		X	X							
	S	VL	3-4	3-6	X	X			Subdominant	X	Birds, Butterflies, Bees	Yellow	X	X								
	S	(Not Listed)	3-6	3-6		X			Occasional		Birds	Yellow		X	X							
	S	VL	3-6	3+					Occasional	X	Birds, Butterflies, Bees	Lavender		X								
	S	VL	2-4	3-5	X				Occasional	X	Birds, Butterflies, Bees	Yellow/Brown	X	X	X	X						
	S/GC	VL	3	2-6		X			Dominant		Bees, Butterflies	Red/Cream			X							
	S	VL	3-5	2-6	X	X	X		Occasional	X	Birds, Butterflies, Bees	Red/Crea			X							
	S/T	VL	8-15	15	X				Occasional	X	Birds, Bees	White			X							
	S	VL	1-3	3		X			Frequent - Occasional	X	Bees, Butterflies	Yellow		X	X	X						
	P/V-D	VL	4	4					Occasional	X	Birds	Red		X	X							
	S	VL	6	6+		X			Occasional	X	Birds, Butterflies	White + Pink		X	X							
	S	VL	10	20	X	X			Frequent	X	Birds	Cream	X	X								
	S	VL	2	2	X		X		Frequent	X	Birds, Butterflies, Bees	Orange/Yellow	X	X	X							
	S	VL	3-5	5	X				Frequent - Occasional	X	Birds, Butterflies, Bees	Yellow/Green	X	X								
	S	M	6-8	6+	X				Occasional	X		Pink		X	X							
	S	VL	6-12	6-12	X				Occasional	X	Birds, Butterflies, Bees	Cream	X	X								
	T/S	VL	8	8		X			Occasional	X	Birds, Butterflies	Cream	X	X								
	S	VL	4	4	X				Frequent - Occasional	X	Birds, Butterflies, Bees	Yellow/Cream	X	X								
	S	VL	6	6	X				Frequent - Occasional	X	Birds, Butterflies, Bees	Yellow/Cream	X	X								
	S	VL	8-10	15	X	X			Frequent - Occasional	X	Birds	Pink	X	X								
	S	VL	3	3-5	X	X			Occasional	X	Birds, Butterflies, Bees	White	X	X	X							

**SPECIES**

**SITING + PERFORMANCE**

BOTANICAL NAME	COMMON NAME	SITING + PERFORMANCE				
		FRAMES FOR BEST PERFORMANCE	CONSTRUCTED CONTEXTS	APPLICATIONS	SUN EXPOSURE	SETBACK FROM PAVEMENT (FEET)
<b>TREES (continued)</b>						
<i>Salvia leucophylla</i>	Purple sage	1-9	A, C, D	+*!	FS	5
<i>Salvia mellifera</i>	Black sage	1-9	A, C, D	+!	FS	4
<i>Trichostema lanatum</i>	Woolly blue curls	1-9	E, F, G		FS	3
<b>PERENNIALS</b>						
<i>Asclepias eriocarpa</i>	Indian milkweed	1-9	C, E, F	+	FS	3
<i>Asclepias fascicularis</i>	Narrow-leaved milkweed	1-9	C, E, F, G	+	FS / PS	3
<i>Corethrogyne filaginifolia</i> var. <i>filaginifolia</i>	California aster	1-9	A, B		FS	2
<i>Croton californicus</i>	California croton	1-9	C, E	*	FS	1
<i>Delphinium cardinale</i>	Scarlet larkspur	1-6, 9	A		FS	2
<i>Epilobium canum</i> ssp. <i>canum</i>	Hoary California fuchsia	1-9	A, B	+	FS / PS	2
<i>Epilobium canum</i> ssp. <i>latifolium</i>	California fuchsia	1-9	A, B	+	FS / PS	2
<i>Eriophyllum confertiflorum</i>	Golden yarrow	1-9	A, B, C	+	FS / PS	1
<i>Eschscholzia californica</i>	California poppy	1-9	C, D		FS / PS	1
<i>Linanthus californicus</i>	Prickly phlox	1-9	A, B, E, F		FS / PS	2
<i>Lotus scaparius</i> (Acmispon <i>glaber</i> )	Deerweed	1-6, 9	A, C	+*	FS	2
<i>Lupinus latifolius</i> var. <i>parishii</i>	Broad-leaf canyon lupine	6-9	B, E, F	+o	FS / PS	2
<i>Malacothrix saxatilis</i>	Cliff aster	1-9	A, B, C, D	+	FS	1
<i>Mirabilis californica</i> ( <i>Mirabilis laevis</i> )	Wishbone bush	1-9	A, C, D	*	FS	2
<i>Pellaea andromedifolia</i>	Coffee fern	3-9	C, E		PS	1
<i>Pellaea mucronata</i>	Bird's foot fern	3-9	C, E	*	PS	1
<i>Penstemon spectabilis</i>	Showy penstemon	1-9	C		FS	2
<i>Polypodium californicum</i>	California polypody fern	6-9	B, G		PS / FS	1
<i>Romneya coulteri</i>	Coulter's Matilija poppy	1-9	A, C, D, E	*	FS	3
<i>Sisyrinchium bellum</i>	Blue-eyed grass	1-9	E, F, G	o	FS / PS	1
<i>Solanum xanti</i>	Purple or chaparral nightshade	1-9	A, C		FS / PS	2
<b>GRASSES</b>						
<i>Bromus carinatus</i> var. <i>carinatus</i>	California brome	1-9	A, B, C, E, F, G	*!	FS / PS	1
<i>Elymus condensatus</i>	Giant wild rye	1-9	A, B, C, E		All	2
<i>Elymus glaucus</i> ssp. <i>glaucus</i>	Blue wild rye	1-9	A, B, C, E, F, G	+	All	3

## DESCRIPTIVE FEATURES

PLANT FORM	WATER USE (WUCOLS IV)	MATURE HEIGHT (FEET)		MATURE WIDTH (FEET)		SHORTLIST PLANT	USACE NATIVE PLANT LIST	SEED LA TARGET LIST	OCCURRENCE IN COMMUNITY	OFTEN AVAILABLE IN CA	POLLINATOR HABITAT	BLOOM COLOR			BLOOM SEASON		
		5	6-8	X	X							Frequent - Occasional	X	Birds, Butterflies, Bees	Lavender/Purple	W	SP
S	VL	5	6-8	X	X				Frequent - Occasional	X	Birds, Butterflies, Bees	Lavender/Purple		X	X		
S	VL	4	6	X	X	X			Frequent	X	Birds, Butterflies, Bees	Lavender/White	X	X	X		
S	VL	2-4	4						Occasional	X	Birds, Butterflies, Bees	Pink/Blue/Lavender	X	X			
P-D	VL	3	1+		X				Occasional	X	Birds, Butterflies	Cream/Pink			X		
P-D	VL	3	2+		X				Occasional	X	Birds, Butterflies	White, Lavender			X	X	
P	L	1-3	1-3	X					Frequent - Occasional	X	Birds, Butterflies, Bees	Purple/Pink/White	X				
P	(Not Listed)	.5-1.5	.5-2		X				Occasional	X		Green		X	X		
P-D	(Not Listed)	2-6	1						Occasional		Birds	Red/Yellow			X		
P	VL	1-3	2-4	X					Frequent		Birds, Butterflies	Red			X		
P	VL	1-3	2-4	X					Occasional	X	Birds, Butterflies	Red			X	X	
P	VL	2	1-3			X			Frequent - Occasional	X	Bees, Butterflies	Yellow		X	X	X	
A/P-D	VL	1	1-2		X				Frequent	X	Birds, Butterflies, Bees	Orange / YellowP		X			
P	M	2	2						Occasional		Bees, Butterflies	Lavender	X	X	X		
P	VL	3	3		X				Frequent	X	Bees, Butterflies	Yellow	X	X	X		
P	L	4	4						Occasional	X	Bees, Butterflies	Blue/Purple		X			
P	M	1-2	1-2						Occasional		Bees, Butterflies	White	X		X	X	
P-D	VL	1	3						Frequent - Occasional	X		Purple/White	X	X			
P	VL	1	2		X				Frequent								
P	VL	1	2		X				Occasional								
P	L	3	3						Occasional	X	Birds	Purple/Blue/Pink	X				
P-D/GC	VL	.5	1+						Occasional	X							
P	VL	6-8	6-8						Frequent	X	Bees, Butterflies	White/Yellow		X	X		
P-D	L	1	1						Frequent - Occasional	X	Butterflies	Purple	X	X			
P-D	VL	2	3						Frequent	X		Purple/Blue	X	X	X		
G/P/GC	(Not Listed)	1.5-3	1+						Frequent	X	Butterflies	Yellow		X			
G/P/GC	L	4-5	3+	X					Occasional	X	Butterflies						
G/P/GC	L	1.5-3	1+						Occasional	X	Butterflies						

**SPECIES**

**SITING + PERFORMANCE**

SPECIES		SITING + PERFORMANCE				
BOTANICAL NAME	COMMON NAME	FRAMES FOR BEST PERFORMANCE	CONSTRUCTED CONTEXTS	APPLICATIONS	SUN EXPOSURE	SETBACK FROM PAVEMENT (FEET)
<b>GRASSES (continued)</b>						
<i>Stipa coronatum</i>	Giant stipa	1-9	A, E, F		FS / PS	2
<i>Stipa lepida</i>	Foothill needlegrass	1-9	A, B, C, D		FS / PS	1
<b>SUCCULENTS</b>						
<i>Dudleya lanceolata</i>	Lance-leaved live-forever	1-9	A		FS / PS	1
<i>Dudleya pulverulenta</i>	Chalk dudleya	1-9	A, B	*	FS / PS	1
<i>Yucca whipplei</i>	Our Lord's candle / chaparral yucca	5-9	A, C	+ *	FS	5
<b>VINES</b>						
<i>Calystegia macrostegia ssp. arida</i>	Southern California morning glory	3-9	B		FS / PS	1
<i>Clematis ligusticifolia</i>	Virgin's bower	3-9	B, E, F, G	o	FS / PS	2
<i>Funastrum cynanchoides var. hartwegii</i>	Twining milkweed	6-9	B, E	*	FS / PS	2
<i>Lathyrus vestitus</i>	Pacific sweet pea	6-9	B		FS / PS	2
<i>Lathyrus vestitus var. alefeldii</i>	Showy Pacific sweet pea	6-9	B		FS / PS	2
<b>GROUNDCOVERS</b>						
<i>Carex praegracilis</i>	Slender sedge	1-9	D, E, F, G	o	FS / PS	1
<i>Euthamia occidentalis</i>	Western goldenrod	3-9	E, F, G	o	FS / PS	1
<i>Solidago californica</i>	California goldenrod	3-9	A, B, F, G	o	FS / PS	1



## DESCRIPTIVE FEATURES

	PLANT FORM	WATER USE (WUCOLS IV)	MATURE HEIGHT (FEET)		MATURE WIDTH (FEET)		SHORTLIST PLANT	USACE NATIVE PLANT LIST	SEED LA TARGET LIST	OCCURRENCE IN COMMUNITY	OFTEN AVAILABLE IN CA	POLLINATOR HABITAT	BLOOM COLOR				BLOOM SEASON			
			W	SP	SU	F														
	G/P/GC	(Not Listed)	2-4	1-2				Occasional	X											
	G/P/GC	VL	2	2		X		Frequent - Occasional	X											
	SC	VL	1	1		X		Occasional	X	Birds, Butterflies	Orange / Pink		X	X						
	SC	VL	1	1		X		Occasional	X	Birds, Bees	Orange/Pink/Red									
	SC	(Not Listed)	3	5	X		X	Frequent - Occasional	X	Birds	Cream		X							
	V/P	L	climbs			X		Frequent - Occasional		Bees	White	X	X	X						
	V-D	L	climbs			X		Occasional	X		Cream				X					
	V/S-D	L	climbs					Occasional		Butterflies	Maroon/White				X	X				
	V/P	(Not Listed)	climbs			X		Occasional	X		Pink/White	X	X							
	V/P	(Not Listed)	climbs					Occasional			Pink/Purple	X	X							
	P/GC	M	.5-1	2+	X			Occasional	X											
	P/GC	L	2-4	2+	X			Frequent - Occasional	X		Yellow / Green				X	X				
	P/GC	M	1	2+	X			Frequent - Occasional	X	Bees, Butterflies	Yellow				X	X				

## CHAPARRAL

### Chaparral (CH) (Chaparral Associations):

Chaparral (Chaparral Associations): Chaparral is considered an upland or drier community that is found on all slope aspects. CH soils are typically shallow and often nutrient-poor. It is suitable as an occasional alternative to the coastal sage scrub and California walnut woodland communities. This community includes tree-like shrubs that can provide some shading in tree-restricted zones. Rigorous design and maintenance of CH plantings can minimize fire hazards associated with this plant community.

- Requires fast draining, nutrient poor soil that is typical of slopes.
- Many species are deciduous in the summer, and over-watering during this time severely compromises the plants' survival.
- Can generally tolerate heat and drier conditions.

**Figure 199. *Juglans californica*.** Source: Consultaplantas, <https://commons.wikimedia.org/w/index.php?curid=44978241>.

**Figure 200. *Cercocarpus betuloides*.** Source: Lazaregagnidze, <https://commons.wikimedia.org/w/index.php?curid=32918241>.

**Figure 201. *Ceanothus oliganthus*.** Source: Anthony Valois and the National Park Service, 2004. [http://researchlearningcenter.org/bloom/species/Ceanothus\\_oliganthus.htm](http://researchlearningcenter.org/bloom/species/Ceanothus_oliganthus.htm).

**Figure 202. *Prunus ilicifolia* ssp. *ilicifolia*.** Source: John Rusk, <https://commons.wikimedia.org/w/index.php?curid=59290247>.

**Figure 203. *Heteromeles arbutifolia*.** Source: Miguel Vieira, <https://commons.wikimedia.org/w/index.php?curid=19525268>.

**Figure 204. *Rhus ovata*.** Source: Bri Weldon, <https://www.flickr.com/photos/briweldon/5228764249>.

**Figure 205. *Eriophyllum confertiflorum*.** Source: Björn S..., <https://www.flickr.com/photos/40948266@N04/43163438812>.

**Figure 206. *Lotus scoparius* (*Acmispon glaber*).** Source: glmory, <https://commons.wikimedia.org/w/index.php?curid=32092287>.

**Figure 207. *Stipa pulchra*.** Source: Matt Lavin. [https://www.flickr.com/photos/plant\\_diversity/35034340452](https://www.flickr.com/photos/plant_diversity/35034340452).





*Juglans californica*



*Cercocarpus betuloides*



*Ceanothus oliganthus*



*Prunus ilicifolia* ssp. *ilicifolia*



*Heteromeles arbutifolia*



*Rhus ovata*



*Eriophyllum confertiflorum*



*Lotus scoparius* (*Acmispon glaber*)



*Stipa pulchra*

CHAPARRAL

**SPECIES**

**SITING + PERFORMANCE**

BOTANICAL NAME	COMMON NAME	SITING + PERFORMANCE				
		FRAMES FOR BEST PERFORMANCE	CONSTRUCTED CONTEXTS	APPLICATIONS	SUN EXPOSURE	SETBACK FROM PAVEMENT (FEET)
<b>TREES</b>						
<i>Adenostoma sparsifolium</i>	Red shanks	3-9	A, C, E	+*!	FS	5
<i>Juglans californica</i> var. <i>californica</i>	California walnut	3-9	B, E, F	+^!	FS / PS	6
<b>SHRUBS</b>						
<i>Adenostoma fasciculatum</i>	Chamise	3-6, 9	A, C, D	*!	FS	4
<i>Arctostaphylos glandulosa</i>	Eastwood manzanita	5-9	B	+	FS / PS	6
<i>Arctostaphylos glauca</i>	Bigberry manzanita	5-9	B	+	FS	6
<i>Artemisia californica</i>	California sagebrush	1-6, 9	A, C, D	*!	FS	3
<i>Ceanothus crassifolius</i>	Hoaryleaf ceanothus	1-9	A, B, C	+!	FS	6
<i>Ceanothus cuneatus</i>	Buck brush	1-9	A, B, C	+!	FS	5
<i>Ceanothus leucodermis</i>	Chaparral whitethorn	5-9	B	+!	FS / PS	6
<i>Ceanothus megacarpus</i>	Big-pod ceanothus	1-9	A, B, C	+!	FS	6
<i>Ceanothus oliganthus</i>	Hairy ceanothus	1-9	A, B, C	+!	FS	6
<i>Ceanothus spinosus</i>	Greenbark ceanothus	1-9	A, C	+!	FS / PS	6
<i>Cercocarpus betuloides</i> var. <i>betuloides</i>	Mountain mahogany	1-9	B, C	+!	FS	6
<i>Dendromecon rigida</i>	Bush poppy	1-6, 9	A, C		FS	5
<i>Diplacus longiflorus</i>	Southern bush monkey flower	1-9	A, B, C, D, E		FS / PS	3
<i>Eriogonum cinereum</i>	Ashyleaf buckwheat	1-5	A, C	+	FS	3
<i>Eriogonum fasciculatum</i> var. <i>foliolosum</i>	Leafy California buckwheat	1-9	A, C	+!	FS / PS	3
<i>Eriogonum fasciculatum</i> var. <i>polifolium</i>	Interior California buckwheat	3-9	A, C	+*!	FS / PS	3
<i>Frangula californica</i> ssp. <i>californica</i>	California coffeeberry	1-9	A, B, C, D	*!	All	6
<i>Heteromeles arbutifolia</i>	Toyon	1-9	A, B, C, E, F	+^!	FS / PS	6
<i>Isocoma menziesii</i> ssp. <i>vernonioides</i>	Goldenbush	1-9	A, C		FS / PS	2
<i>Keckiella cordifolia</i>	Heart-leaved penstemon	1-9	A, B, C, E		All	3
<i>Lepechinia fragrans</i>	Fragrant pitcher sage	3-9	A, B, C	+*!	FS / PS	3
<i>Lonicera subspicata</i> var. <i>denudata</i>	Chaparral honeysuckle	1-9	A, B		FS	2
<i>Malosma laurina</i>	Laurel sumac	1-9	A, C	+!	FS	6
<i>Mimulus aurantiacus</i>	Bush monkey flower	1-9	A, B, C		FS / PS	2



## DESCRIPTIVE FEATURES

	PLANT FORM	WATER USE (WUCOLS IV)	MATURE HEIGHT (FEET)		MATURE WIDTH (FEET)			SHORTLIST PLANT	USACE NATIVE PLANT LIST	SEED LA TARGET LIST	OCCURRENCE IN COMMUNITY	OFTEN AVAILABLE IN CA	POLLINATOR HABITAT	BLOOM COLOR				BLOOM SEASON			
			W	SP	SU	F	W							SP	SU	F					
	T/S	VL	8-20	15						Occasional	X	Birds, Bees	White				X	X			
	T-D	L	15-25	20	X	X				Occasional	X	Birds	Yellow		X						
	S	VL	4-8	6	X					Occasional	X	Birds, Butterflies, Bees	White		X	X					
	S	VL	3-12	8						Occasional		Birds, Butterflies, Bees	White + Pink	X	X						
	T/S	VL	6-15	6-15						Occasional		Birds, Bees	White + Pink	X	X						
	S	VL	3	2-3	X	X	X			Frequent	X	Birds, Butterflies	White + Yellow		X	X	X				
	S	(Not Listed)	6-15	8-20						Frequent	X	Birds, Butterflies, Bees	White	X	X						
	S	VL	5-12	5-12						Occasional	X	Birds, Butterflies, Bees	White	X	X	X					
	S	VL	10-12	10-20						Occasional	X	Birds, Butterflies, Bees	Blue/Lavender	X	X						
	S	VL	6-15	8-20						Subdominant	X	Birds, Butterflies, Bees	White/Lavender	X	X						
	S	(Not Listed)	8-10	8-10						Occasional	X	Birds, Butterflies, Bees	Blue/Purple	X	X						
	S/T	VL	8-20	10-20						Subdominant	X	Birds, Butterflies, Bees	Blue/White	X	X						
	T/S	VL	6-20	12	X					Frequent	X	Birds	Yellow/Cream	X	X						
	S	VL	8-12	10-15						Occasional	X	Bees, Butterflies	Yellow	X	X						
	S	(Not Listed)	1-3	1-3						Occasional		Bees, Butterflies	Yellow		X	X					
	S	VL	2-4	3-5	X					Occasional	X	Birds, Butterflies, Bees	Yellow/Brown	X	X	X	X				
	S	VL	3-5	2-6	X	X	X			Occasional	X	Birds, Butterflies, Bees	Red/Cream				X				
	S	VL	3-5	2-6						Subdominant	X	Birds, Butterflies, Bees	Pink/Cream				X				
	S	VL	8	12	X					Frequent	X	Birds, Butterflies, Bees	Cream		X	X					
	S/T	VL	8-15	15	X					Subdominant	X	Birds, Bees	White				X				
	S	VL	1-3	3		X				Occasional	X	Bees, Butterflies	Yellow		X	X	X				
	P/V-D	VL	4	4						Occasional	X	Birds	Red		X	X					
	S	L	3-5	3-5						Occasional	X	Birds, Butterflies	Purple/Lavender		X	X	X				
	V/S	L	climbs							Occasional	X	Birds	Yellow/Cream		X	X					
	S	VL	10	20	X	X				Occasional	X	Birds	Cream	X	X						
	S	VL	2	2	X		X			Occasional	X	Birds, Butterflies, Bees	Orange/Yellow	X	X	X					

**SPECIES**

**SITING + PERFORMANCE**

BOTANICAL NAME	COMMON NAME	SITING + PERFORMANCE				
		FRAMES FOR BEST PERFORMANCE	CONSTRUCTED CONTEXTS	APPLICATIONS	SUN EXPOSURE	SETBACK FROM PAVEMENT (FEET)
<b>SHRUBS (continued)</b>						
<i>Prunus ilicifolia</i> ssp. <i>ilicifolia</i>	Hollyleaf cherry	5-9	A, B, C	+!	FS / PS	4
<i>Quercus berberidifolia</i>	Scrub oak	1-9	A, B, C	+!	FS	6
<i>Rhamnus crocea</i>	Spiny redberry	5-9	A, B, C	+!	All	4
<i>Rhamnus ilicifolia</i>	Hollyleaf redberry	5-9	A, B, C	+!	All	5
<i>Rhus aromatica</i>	Fragrant sumac	1-9	A, B, C, E, F	+	FS / PS	4
<i>Rhus integrifolia</i>	Lemonadeberry	1-9	A, B, C	+!	FS / PS	6
<i>Rhus ovata</i>	Sugar bush	1-9	A, C	+*!	FS / PS	6
<i>Ribes californicum</i> var. <i>hesperium</i>	Hillside gooseberry	3-9	B, F, G	+	PS	4
<i>Ribes malvaceum</i> var. <i>viridifolium</i>	Chaparral currant	3-9	B, F	+	PS	3
<i>Ribes speciosum</i>	Fuchsia-flowered gooseberry	3-9	B, F	+	PS / FS	4
<i>Romneya coulteri</i>	Coulter's Matilija poppy	1-9	A, C, D, E	*	FS	3
<i>Salvia apiana</i>	White sage	3-9	A, C, D	+!	FS	3
<i>Salvia mellifera</i>	Black sage	1-9	A, C, D	+!	FS	4
<i>Trichostema lanatum</i>	Woolly blue curls	1-9	E, F, G		FS	3
<b>PERENNIALS</b>						
<i>Acourtia microcephala</i>	Sacapellote	1-9	A, B, C	+	FS	1
<i>Asclepias eriocarpa</i>	Indian milkweed	1-9	C, E, F	+	FS	3
<i>Asclepias fascicularis</i>	Narrow-leaved milkweed	1-9	C, E, F, G	+	FS / PS	3
<i>Corethrogyne filaginifolia</i> var. <i>filaginifolia</i>	California aster	1-9	A, B		FS	2
<i>Delphinium cardinale</i>	Scarlet larkspur	1-6; 9	A, C, E		FS	2
<i>Epilobium canum</i> ssp. <i>canum</i>	Hoary California fuchsia	1-9	A, B	+	FS / PS	2
<i>Epilobium canum</i> ssp. <i>latifolium</i>	California fuchsia	1-9	A, B	+	FS / PS	2
<i>Eriogonum elongatum</i>	Longstem buckwheat	1-9	A, B, C	+	FS	1
<i>Eriophyllum confertiflorum</i>	Golden yarrow	1-9	A, B, C	+	FS / PS	1
<i>Lotus scoparius</i> ( <i>Acmispon glaber</i> )	Deerweed	1-6, 9	A, C	+*	FS	2
<i>Lupinus longifolius</i>	Blue bush lupine	1-9	A, B		FS / PS	2



## DESCRIPTIVE FEATURES

	PLANT FORM	WATER USE (WUCOLS IV)	MATURE HEIGHT (FEET)		MATURE WIDTH (FEET)		SHORTLIST PLANT	USACE NATIVE PLANT LIST	SEED LA TARGET LIST	OCCURRENCE IN COMMUNITY	OFTEN AVAILABLE IN CA	POLLINATOR HABITAT	BLOOM COLOR				BLOOM SEASON			
			W	SP	SU	F							W	SP	SU	F				
	S	VL	6-12	6-12	X			Subdominant	X	Birds, Butterflies, Bees	Cream	X	X							
	T/S	VL	8	8		X		Subdominant	X	Birds, Butterflies	Cream	X	X							
	S	VL	4	4	X			Frequent	X	Birds, Butterflies, Bees	Yellow/Cream	X	X							
	S	VL	6	6	X			Frequent	X	Birds, Butterflies, Bees	Yellow/Cream	X	X							
	S-D	L	3-5	4-8		X		Occasional		Birds	Yellow/Cream			X						
	S	VL	8-10	15	X	X		Frequent	X	Birds	Pink	X	X							
	S	VL	8-10	15	X	X		Frequent	X	Birds	Pink/White	X	X							
	S-D	L	5	5-8	X	X		Occasional	X	Birds, Butterflies, Bees	Purple/Yellow	X	X							
	S-D	VL	5-8	5		X		Occasional	X	Birds, Butterflies, Bees	Pink/Purple	X	X							
	S-D	VL	5-8	6-8	X	X		Occasional	X	Birds, Butterflies, Bees	Red/Pink	X	X							
	P	VL	6-8	6-8				Frequent	X	Bees, Butterflies	White/Yellow			X	X					
	S	VL	3	3-5	X	X		Occasional	X	Birds, Butterflies, Bees	White	X	X	X						
	S	VL	4	6	X	X	X	Frequent	X	Birds, Butterflies, Bees	Lavender/White	X	X	X						
	S	VL	2-4	4				Occasional	X	Birds, Butterflies, Bees	Pink/Blue/Lavender	X	X							
	P	(Not Listed)	4	1				Occasional		Butterflies	Pink				X					
	P-D	VL	3	1+		X		Occasional	X	Birds, Butterflies	Cream/Pink				X					
	P-D	VL	3	2+		X		Occasional	X	Birds, Butterflies	White, Lavender				X	X				
	P	L	1-3	1-3	X			Frequent - Occasional	X	Birds, Butterflies, Bees	Purple/Pink/White	X								
	P-D	(Not Listed)	2-6	1				Occasional		Birds, Bees	Red/Yellow			X	X					
	P	VL	1-3	2-4	X			Occasional		Birds, Butterflies	Red				X	X				
	P	VL	1-3	2-4	X			Occasional	X	Birds, Butterflies	Red				X	X				
	P	VL	6	1				Occasional		Birds, Butterflies, Bees	Cream/Pink				X	X				
	P	VL	2	1-3			X	Frequent	X	Bees, Butterflies	Yellow			X	X	X				
	P	VL	3	3		X		Frequent	X	Bees, Butterflies	Yellow	X	X	X						
	P	(Not Listed)	4	4		X		Occasional		Birds, Bees	Purple/Blue	X	X	X	X					

**SPECIES**

**SITING + PERFORMANCE**

BOTANICAL NAME	COMMON NAME	SITING + PERFORMANCE					
		FRAMES FOR BEST PERFORMANCE	CONSTRUCTED CONTEXTS	APPLICATIONS	SUN EXPOSURE	SETBACK FROM PAVEMENT (FEET)	
<b>PERENNIALS (continued)</b>							
<i>Penstemon centranthifolius</i>	Scarlet bugler	1-9	A, B, C, E, F	+	FS	2	
<i>Penstemon heterophyllus var. australis</i>	Foothill penstemon	1-3; 6-9	A, B, C		FS / PS	1	
<i>Penstemon spectabilis</i>	Showy penstemon	1-9	C		FS	2	
<i>Solanum xanti</i>	Purple or chaparral nightshade	1-9	A, C		FS / PS	2	
<b>GRASSES</b>							
<i>Bothriochloa barbinodis</i>	Cane bluegrass	1-9	A, C		FS	1	
<i>Bromus carinatus var. carinatus</i>	California brome	1-9	A, B, C, E, F, G	*!	FS / PS	1	
<i>Elymus condensatus</i>	Giant wild rye	1-9	A, B, C, E		All	2	
<i>Elymus glaucus ssp. glaucus</i>	Blue wild rye	1-9	A, B, C, E, F, G	+	All	3	
<i>Muhlenbergia rigens</i>	Deergrass	1-9	A, B, C, E, F		FS / PS	3	
<i>Stipa cernua</i>	Nodding needlegrass	1-9	A, B, C, E		FS / PS	1	
<i>Stipa coronatum</i>	Giant stipa	1-9	A, E, F		FS / PS	2	
<i>Stipa lepida</i>	Foothill needlegrass	1-9	A, B, C, D		FS / PS	1	
<i>Stipa pulchra</i>	Purple needlegrass	1-9	A, B, C, E	*!	FS / PS	1	
<b>SUCCULENTS</b>							
<i>Dudleya pulverulenta</i>	Chalk dudleya	1-9	A, B	*	FS / PS	1	
<i>Yucca whipplei</i>	Our Lord's candle / chaparral yucca	5-9	A, C	+ *	FS	5	
<b>VINES</b>							
<i>Clematis lasiantha</i>	Pipestems	3-9	A, B		FS / PS	2	
<i>Clematis ligusticifolia</i>	Virgin's bower	3-9	B, E, F, G	o	FS / PS	2	
<i>Lathyrus vestitus</i>	Pacific sweet pea	6-9	B		FS / PS	2	
<i>Lathyrus vestitus var. alefeldii</i>	Showy Pacific sweet pea	6-9	B		FS / PS	2	
<b>GROUNDCOVERS</b>							
<i>Salvia spathacea</i>	Hummingbird sage	1-9	B, C, E		PS / FS	2	
<i>Solidago californica</i>	California goldenrod	3-9	A, B, F, G	o	FS / PS	1	
<i>Solidago confinis</i>	Southern goldenrod	3-9	E, F, G	o	FS / PS	1	
<i>Symphoricarpos mollis</i>	Creeping snowberry	3-9	B, E	!	PS / FS	2	

## DESCRIPTIVE FEATURES

	PLANT FORM	WATER USE (WUCOLS IV)	MATURE HEIGHT (FEET)			MATURE WIDTH (FEET)			SHORTLIST PLANT	USACE NATIVE PLANT LIST	SEED LA TARGET LIST	OCCURRENCE IN COMMUNITY	OFTEN AVAILABLE IN CA	POLLINATOR HABITAT	BLOOM COLOR				BLOOM SEASON			
			W	SP	SU	F																
	P	L	1	1-2					Occasional	X	Birds, Butterflies, Bees		Red		X	X						
	P	L	1	2					Occasional	X	Birds, Butterflies, Bees		Purple/Blue	X	X	X						
	P	L	3	3					Occasional	X	Birds		Purple/Blue/Pink	X								
	P-D	VL	2	3					Frequent	X			Purple/Blue	X	X	X						
	G/P/GC	L	2-4	1					Occasional	X			Yellow	X	X	X	X					
	G/P/GC	(Not Listed)	1.5-3	1+					Frequent	X	Butterflies		Yellow		X							
	G/P/GC	L	4-5	3+	X				Occasional	X	Butterflies											
	G/P/GC	L	1.5-3	1+					Occasional	X	Butterflies											
	G/P/GC	L	3	4	X				Occasional	X	Birds											
	G/P/GC	VL	2	2					Occasional	X												
	G/P/GC	(Not Listed)	2-4	1-2					Occasional	X												
	G/P/GC	VL	2	2		X			Occasional	X												
	G/P/GC	VL	2	2		X			Occasional	X	Butterflies		Cream			X						
	SC	VL	1	1		X			Occasional	X	Birds, Bees		Orange/Pink/Red									
	SC	(Not Listed)	3	5	X		X		Frequent	X	Birds		Cream			X						
	V-D	VL	climbs			X			Occasional	X			Cream		X	X						
	V-D	L	climbs			X			Occasional	X			Cream				X					
	V/P	(Not Listed)	climbs				X		Occasional	X			Pink/White	X	X							
	V/P	(Not Listed)	climbs						Occasional				Pink/Purple	X	X							
	P/GC	L	1	3+	X				Occasional	X	Birds, Butterflies, Bees		Red/Pink	X	X	X						
	P/GC	M	1	2+	X				Frequent - Occasional	X	Bees, Butterflies		Yellow			X	X					
	P/GC	M	1	2+	X				Frequent - Occasional		Bees		Yellow		X	X	X					
	S-D/GC	L	2	2+	X				Occasional	X	Birds, Butterflies, Bees		Pink		X	X						

## SOUTHERN COAST LIVE OAK RIPARIAN FOREST

### Southern coast live oak riparian forest (CLORF) (Coast Live Oak Association):

This forest community is found along bottomlands and outer floodplains along larger streams on fine-grained, rich alluvium. This community differs structurally from coast live oak riparian woodland in having a relatively closed tree canopy at maturity, and thus supports understory species adapted to partial or full shade. CLORF may be appropriate for relatively moist zones, particularly with north-facing slopes, such as in the Sepulveda Basin vicinity.

- Understory is adapted to partial or full shade.
- Typically found in stream beds, moist areas, or north-facing slopes.
- Can tolerate periodic flooding.

**Figure 208.** *Quercus agrifolia*. Source: Stickpen, <https://commons.wikimedia.org/w/index.php?curid=9944130>.

**Figure 209.** *Fraxinus velutina* var. *coriacea*. Source: Kenraiz, <https://commons.wikimedia.org/w/index.php?curid=75992775>.

**Figure 210.** *Platanus racemosa*. Source: Raffi Kojian, <http://www.gardenology.org>, <https://commons.wikimedia.org/w/index.php?curid=9705655>.

**Figure 211.** *Populus trichocarpa*. Source: Daniel Mayer, <https://commons.wikimedia.org/w/index.php?curid=7381945>.

**Figure 212.** *Keckiella cordifolia*. Source: Björn S..., [https://commons.wikimedia.org/wiki/File:Heartleaf\\_Keckiella\\_-\\_Keckiella\\_cordifolia\\_\(43818527031\).jpg](https://commons.wikimedia.org/wiki/File:Heartleaf_Keckiella_-_Keckiella_cordifolia_(43818527031).jpg)

**Figure 213.** *Ribes aureum* var. *gracillimum*. Source: John Rusk, [https://www.flickr.com/photos/john\\_d\\_rusk/8941180855](https://www.flickr.com/photos/john_d_rusk/8941180855).

**Figure 214.** *Artemisia douglasiana*. Source: Römert, <https://commons.wikimedia.org/w/index.php?curid=19802958>.

**Figure 215.** *Rosa californica*. Source: Bill Leikam, <https://commons.wikimedia.org/w/index.php?curid=40893617>.

**Figure 216.** *Dryopteris arguta*. Source: John Rusk, <https://commons.wikimedia.org/w/index.php?curid=59291429>.





*Quercus agrifolia*



*Fraxinus velutina var. coriacea*



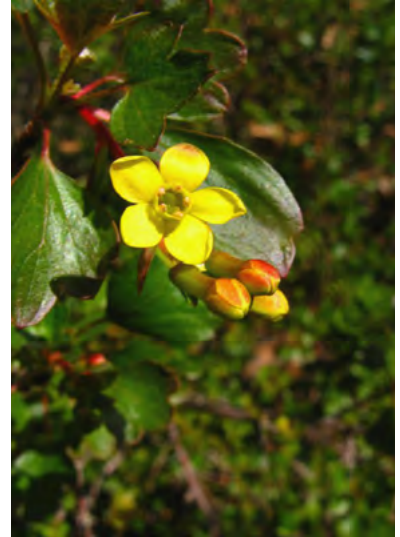
*Platanus racemosa*



*Populus trichocarpa*



*Keckiella cordifolia*



*Ribes aureum var. gracillimum*



*Artemisia douglasiana*



*Rosa californica*



*Dryopteris arguta*

**SPECIES**

**SITING + PERFORMANCE**

BOTANICAL NAME	COMMON NAME	SITING + PERFORMANCE				
		FRAMES FOR BEST PERFORMANCE	CONSTRUCTED CONTEXTS	APPLICATIONS	SUN EXPOSURE	SETBACK FROM PAVEMENT (FEET)
<b>TREES</b>						
<i>Acer negundo</i>	Box elder	5-9	E, F, G	+ ^ ~ o	FS / PS	6
<i>Fraxinus velutina</i> var. <i>coriacea</i>	Velvet ash	1-9	B, E, F, G	+ ^ ! o	FS / PS	6
<i>Juglans californica</i> var. <i>californica</i>	California walnut	3-9	B, E, F	+ ^ !	FS / PS	6
<i>Platanus racemosa</i>	California sycamore	1-9	E, F	+ ^ ~ o	FS	6
<i>Populus fremontii</i> ssp. <i>fremontii</i>	Fremont cottonwood	1-9	F, G	+ ^ ~ o	FS	8
<i>Populus trichocarpa</i>	Black cottonwood	1-9	F, G	+ ^ ~ o	FS	8
<i>Quercus agrifolia</i> var. <i>agrifolia</i>	Coast live oak	1-9	A, B, C	+ ^	FS	8
<i>Sambucus nigra</i> ssp. <i>caerulea</i>	Mexican elderberry	1-9	C, E, F	+ ^ ~ o	FS	6
<i>Umbellularia californica</i>	California bay laurel	1-9	B, E, F	+ ^ !	FS / PS	6
<b>SHRUBS</b>						
<i>Amorpha fruticosa</i>	Indigobush	1-9	B, F, G	+ ~ o	FS / PS	3
<i>Artemisia californica</i>	California sagebrush	1-6, 9	A, C, D	* !	FS	3
<i>Baccharis pilularis</i> var. <i>consanguinea</i>	Coyote brush	1-5	A, C, D	* !	FS / PS	4
<i>Baccharis salicifolia</i>	Mulefat	1-9	F, G	+ ~ o	All	3
<i>Berberis pinnata</i>	California barberry	5-9	B, E, F	+ !	FS / PS	4
<i>Ceanothus oliganthus</i>	Hairy ceanothus	1-9	A, B, C	+ !	FS	6
<i>Eriogonum fasciculatum</i> var. <i>foliolosum</i>	Leafy California buckwheat	1-9	A, C	+ !	FS / PS	3
<i>Fragula californica</i> ssp. <i>californica</i>	California coffeeberry	1-9	A, B, C, D	* !	All	6
<i>Heteromeles arbutifolia</i>	Toyon	1-9	A, B, C, E, F	+ ^ !	FS / PS	6
<i>Isocoma menziesii</i> ssp. <i>vernonioides</i>	Goldenbush	1-9	A, C		FS / PS	2
<i>Keckiella cordifolia</i>	Heart-leaved penstemon	1-9	A, B, C, E		All	3
<i>Lonicera subspicata</i> var. <i>denudata</i>	Chaparral honeysuckle	1-9	A, B		FS	2
<i>Malosma laurina</i>	Laurel sumac	1-9	A, C	+ !	FS	6
<i>Mimulus aurantiacus</i>	Bush monkey flower	1-9	A, B, C		FS / PS	2
<i>Prunus ilicifolia</i> ssp. <i>ilicifolia</i>	Hollyleaf cherry	5-9	A, B, C	+ !	FS / PS	4
<i>Rhamnus ilicifolia</i>	Hollyleaf redberry	5-9	A, B, C	+ !	All	5
<i>Rhus aromatica</i>	Fragrant sumac	1-9	A, B, C, E, F	+	FS / PS	4
<i>Rhus integrifolia</i>	Lemonadeberry	1-9	A, B, C	+ !	FS / PS	6



## DESCRIPTIVE FEATURES

	PLANT FORM	WATER USE (WUCOLS IV)	MATURE HEIGHT (FEET)			MATURE WIDTH (FEET)			SHORTLIST PLANT	USACE NATIVE PLANT LIST	SEED LA TARGET LIST	OCCURRENCE IN COMMUNITY	OFTEN AVAILABLE IN CA	POLLINATOR HABITAT	BLOOM COLOR				BLOOM SEASON					
			W	SP	SU	F	W	SP							SU	F								
	T-D	M	30-60	40					Occasional	X	Birds, Butterflies	Yellow/Cream	X	X										
	T-D	M	20-30	20-30		X			Frequent - Occasional	X	Birds, Butterflies	Yellow		X										
	T-D	L	15-25	20	X	X			Occasional	X	Birds	Yellow		X										
	T-D	M	40	40	X	X			Subdominant	X	Birds, Butterflies	Yellow/Cream	X	X										
	T-D	M	30	35					Occasional	X	Birds, Butterflies	Cream	X	X										
	T-D	M	30	30+					Frequent - Occasional	X	Birds, Butterflies	Yellow	X	X										
	T	VL / L	40	40	X	X			Dominant	X	Birds, Butterflies	Yellow		X										
	T-D	L	15	20	X	X			Frequent - Occasional	X	Birds, Butterflies, Bees	Yellow/Cream		X	X									
	T	L	30	30					Frequent - Occasional	X	Birds	Yellow/Cream; SP		X										
	S-D	M	3-8	3-8					Occasional	X	Birds, Butterflies	Purple/Yellow	X	X										
	S	VL	3	2-3	X	X	X		Occasional	X	Birds, Butterflies	White + Yellow		X	X	X	X							
	S	L	4-6	6-8	X	X			Occasional	X	Bees, Butterflies	Yellow/Cream	X	X	X	X								
	S	H	4-8	6-10	X	X			Occasional	X	Bees, Butterflies	White/Pink/White	X	X	X	X								
	S	L	4-6	4+					Occasional	X	Birds, Butterflies, Bees	Yellow	X	X										
	S	(Not Listed)	8-10	8-10					Occasional	X	Birds, Butterflies, Bees	Blue/Purple	X	X										
	S	VL	3-5	2-6	X	X	X		Occasional	X	Birds, Butterflies, Bees	Red/Cream				X								
	S	VL	8	12	X				Frequent	X	Birds, Butterflies, Bees	Cream		X	X									
	S/T	VL	8-15	15	X				Occasional	X	Birds, Bees	White				X								
	S	VL	1-3	3		X			Occasional	X	Bees, Butterflies	Yellow		X	X	X								
	P/V-D	VL	4	4					Occasional	X	Birds	Red		X	X									
	V/S	L	climbs						Occasional	X	Birds	Yellow/Cream		X	X									
	S	VL	10	20	X	X			Frequent	X	Birds	Cream	X	X										
	S	VL	2	2	X		X		Occasional	X	Birds, Butterflies, Bees	Orange/Yellow	X	X	X									
	S	VL	6-12	6-12	X				Frequent	X	Birds, Butterflies, Bees	Cream	X	X										
	S	VL	6	6	X				Frequent - Occasional	X	Birds, Butterflies, Bees	Yellow/Cream	X	X										
	S-D	L	3-5	4-8		X			Frequent - Occasional		Birds	Yellow/Cream		X										
	S	VL	8-10	15	X	X			Occasional	X	Birds	Pink	X	X										

**SPECIES**

**SITING + PERFORMANCE**

BOTANICAL NAME	COMMON NAME	SITING + PERFORMANCE				
		FRAMES FOR BEST PERFORMANCE	CONSTRUCTED CONTEXTS	APPLICATIONS	SUN EXPOSURE	SETBACK FROM PAVEMENT (FEET)
<b>SHRUBS (continued)</b>						
<i>Ribes aureum</i> var. <i>gracillimum</i>	Golden currant	3-9	A, B, C, E, F		FS / PS	3
<i>Ribes californicum</i> var. <i>hesperium</i>	Hillside gooseberry	3-9	B, F, G	+	PS	4
<i>Ribes speciosum</i>	Fuchsia-flowered gooseberry	3-9	B, F	+	PS / FS	4
<i>Rosa californica</i>	California wild rose	1-9	E, F, G		All	3
<i>Salvia apiana</i>	White sage	3-9	A, C, D	+!	FS	3
<i>Venegasia carpesioides</i>	Canyon sunflower	1-9	B, E, F	+!	All	3
<b>PERENNIALS</b>						
<i>Artemisia douglasiana</i>	Mugwort	1-9	A, B, C, E	!~o	All	3
<i>Dryopteris arguta</i>	Coastal wood fern	1-9	E, F, G	o	PS / FS	1
<i>Eriophyllum confertiflorum</i>	Golden yarrow	1-9	A, B, C	+	FS / PS	1
<i>Juncus patens</i>	California grey rush	1-9	E, F, G	~o	FS / PS	2
<i>Juncus torreyi</i>	Rush	1-9	E, F, G	~o	FS / PS	1-2
<i>Lotus scoparius</i> ( <i>Acmispon glaber</i> )	Deerweed	1-6, 9	A, C	+*	FS	2
<i>Lupinus latifolius</i> var. <i>parishii</i>	Broad-leaf canyon lupine	6-9	B, E, F	+o	FS / PS	2
<i>Thalictrum fendleri</i> var. <i>polycarpum</i>	Meadow rue	6-9	B, F, G	o	PS / FS	2
<b>GRASSES</b>						
<i>Agrostis exarata</i>	Bent grass	1-9	A, B, C, E, F, G		FS / PS	1-2
<i>Bromus carinatus</i> var. <i>carinatus</i>	California brome	1-9	A, B, C, E, F, G	*!	FS / PS	1
<i>Elymus condensatus</i>	Giant wild rye	1-9	A, B, C, E		All	2
<i>Elymus glaucus</i> ssp. <i>glaucus</i>	Blue wild rye	1-9	A, B, C, E, F, G	+	All	3
<i>Muhlenbergia rigens</i>	Deergrass	1-9	A, B, C, E, F		FS / PS	3
<b>VINES</b>						
<i>Clematis lasiantha</i>	Pipestems	3-9	A, B		FS / PS	2
<i>Clematis ligusticifolia</i>	Virgin's bower	3-9	B, E, F, G	o	FS / PS	2
<i>Lathyrus vestitus</i>	Pacific sweet pea	6-9	B		FS / PS	2
<i>Vitis girdiana</i>	Desert grape	3-9	G	o	All	2
<b>GROUNDCOVERS</b>						
<i>Carex praegracilis</i>	Slender sedge	1-9	D, E, F, G	o	FS / PS	1

## DESCRIPTIVE FEATURES

PLANT FORM	WATER USE (WUCOLS IV)	MATURE HEIGHT (FEET)			MATURE WIDTH (FEET)			SHORTLIST PLANT	USACE NATIVE PLANT LIST	SEED LA TARGET LIST	OCCURRENCE IN COMMUNITY	OFTEN AVAILABLE IN CA	POLLINATOR HABITAT	BLOOM COLOR				BLOOM SEASON			
		W	SP	SU	F	W	SP							SU	F						
S-D	VL	6-8	6-8	X	X	X	Frequent - Occasional	X	Birds, Butterflies, Bees	Yellow/Cream	X	X									
S-D	L	5	5-8	X	X		Occasional	X	Birds, Butterflies, Bees	Purple/Yellow	X	X									
S-D	VL	5-8	6-8	X	X		Occasional	X	Birds, Butterflies, Bees	Red/Pink	X	X									
S	L	4-6	4+	X			Frequent - Occasional	X	Birds, Butterflies, Bees	Pink		X	X								
S	VL	3	3-5	X	X		Occasional	X	Birds, Butterflies, Bees	White	X	X	X								
S	L	4	4				Occasional	X	Birds, Bees	Yellow	X	X									
P	M	3-5	3+	X	X		Frequent	X	Birds, Butterflies	Yellow/Cream		X	X	X							
P	L	1-2	2+		X		Frequent														
P	VL	2	1-3			X	Frequent - Occasional	X	Bees, Butterflies	Yellow		X	X	X							
P/GC	L	2.5	3+	X			Occasional	X													
P	M	2-3	3+				Occasional			Red/Brown			X								
P	VL	3	3		X		Occasional	X	Bees, Butterflies	Yellow	X	X	X								
P	L	4	4				Occasional	X	Bees, Butterflies	Blue/Purple		X									
P	M	2	2				Occasional	X		Yellow		X	X								
G/P/GC	(Not Listed)	2-4	2				Frequent		Butterflies												
G/P/GC	(Not Listed)	1.5-3	1+				Frequent	X	Butterflies	Yellow; SP		X									
G/P/GC	L	4-5	3+	X			Occasional	X	Butterflies												
G/P/GC	L	1.5-3	1+				Frequent - Occasional	X	Butterflies												
G/P/GC	L	3	4	X			Occasional	X	Birds												
V-D	VL	climbs		X			Occasional	X		Cream		X	X								
V-D	L	climbs		X			Occasional	X		Cream			X								
V/P	(Not Listed)	climbs			X		Occasional	X		Pink/White	X	X									
V/S-D	L	climbs		X			Occasional	X	Birds	Green		X									
P/GC	M	.5-1	2+	X			Occasional	X													

**SPECIES**

**SITING + PERFORMANCE**

SPECIES		SITING + PERFORMANCE				
BOTANICAL NAME	COMMON NAME	FRAMES FOR BEST PERFORMANCE	CONSTRUCTED CONTEXTS	APPLICATIONS	SUN EXPOSURE	SETBACK FROM PAVEMENT (FEET)
<b>GROUNDCOVERS (continued)</b>						
<i>Corethrogyne filaginifolia</i> var. <i>filaginifolia</i>	California aster	1-9	A, B		FS	2
<i>Elymus triticoides</i>	Creeping wild rye	1-9	B, E, F, G	!	All	2
<i>Salvia spathacea</i>	Hummingbird sage	1-9	B, C, E		PS / FS	2
<i>Solidago californica</i>	California goldenrod	3-9	A, B, F, G	o	FS / PS	1
<i>Solidago confinis</i>	Southern goldenrod	3-9	E, F, G	o	FS / PS	1
<i>Stachys bullata</i>	Pink hedgenettle	1-9	E, F, G	+ ~ o	PS / FS	2
<i>Symphoricarpos mollis</i>	Creeping snowberry	3-9	B, E	!	PS / FS	2

## DESCRIPTIVE FEATURES

	PLANT FORM	WATER USE (WUCOLS IV)	MATURE HEIGHT (FEET)		MATURE WIDTH (FEET)		SHORTLIST PLANT	USACE NATIVE PLANT LIST	SEED LA TARGET LIST	OCCURRENCE IN COMMUNITY	OFTEN AVAILABLE IN CA	POLLINATOR HABITAT	BLOOM COLOR				BLOOM SEASON			
			W	SP	SU	F														
	P/GC	L	1-3	1-3	X			Occasional	X	Birds, Butterflies, Bees	Purple/Pink/White	X								
	G/P/GC	L	2	2+	X			Occasional	X	Butterflies										
	P/GC	L	1	3+	X			Occasional	X	Birds, Butterflies, Bees	Red/Pink	X	X	X						
	P/GC	M	1	2+	X			Frequent - Occasional	X	Bees, Butterflies	Yellow				X	X				
	P/GC	M	1	2+	X			Frequent - Occasional		Bees	Yellow		X	X	X					
	P/GC	L	1-2	2+	X	X		Frequent - Occasional	X	Birds, Butterflies, Bees	Lavender/Purple		X	X	X					
	S-D/GC	L	2	2+	X			Frequent - Occasional	X	Birds, Butterflies, Bees	Pink		X	X						

## COAST LIVE OAK WOODLAND

### Coast live oak woodland (CLOW) (Coast Live Oak Association):

CLOW is commonly found on slopes that are often very steep or on raised stream banks and terraces. Its soils are mostly sandstone or shale-derived. Coast live oak (*Quercus agrifolia*) woodland is a tree-dominated community comprising fewer trees and considerably drier soils than southern coast live oak forest.

- Requires fast draining, nutrient poor soil that is typical of slopes.
- Many species are deciduous in the summer, and over-watering during this time severely compromises the plants' survival.
- Can generally tolerate relatively dry conditions.

**Figure 217.** *Quercus agrifolia*. Source: Stickpen, <https://commons.wikimedia.org/w/index.php?curid=9944130>.

**Figure 218.** *Sambucus nigra ssp. caerulea*. Source: Stan Shebs, <https://commons.wikimedia.org/w/index.php?curid=1953423>

**Figure 219.** *Umbellularia californica*. Source: Krzysztof Ziarnek, Kenraiz, <https://commons.wikimedia.org/w/index.php?curid=54448438>.

**Figure 220.** *Prunus ilicifolia ssp. ilicifolia*. Source: John Rusk, <https://commons.wikimedia.org/w/index.php?curid=59290247>.

**Figure 221.** *Ribes californicum*. Source: Tom Hilton, [https://commons.wikimedia.org/wiki/File:Ribes\\_californicum.jpg](https://commons.wikimedia.org/wiki/File:Ribes_californicum.jpg).

**Figure 222.** *Rhus aromatica*. Source: David J. Stang, <https://commons.wikimedia.org/w/index.php?curid=61092418>.

**Figure 223.** *Sisyrinchium bellum*. Source: Franco Folini, <https://www.flickr.com/photos/livenature/4350730696>.

**Figure 224.** *Bromus carinatus var. carinatus*. Source: Matt Lavin, <https://commons.wikimedia.org/w/index.php?curid=25134214>.

**Figure 225.** *Muhlenbergia rigens*. Source: Krzysztof Ziarnek, Kenraiz, <https://commons.wikimedia.org/w/index.php?curid=54450777>.





*Quercus agrifolia*



*Sambucus nigra ssp. caerulea*



*Umbellularia californica*



*Prunus ilicifolia ssp. ilicifolia*



*Ribes californicum*



*Rhus aromatica*



*Sisyrinchium bellum*



*Bromus carinatus var. carinatus*



*Muhlenbergia rigens*

**SPECIES**

**SITING + PERFORMANCE**

BOTANICAL NAME	COMMON NAME	SITING + PERFORMANCE				
		FRAMES FOR BEST PERFORMANCE	CONSTRUCTED CONTEXTS	APPLICATIONS	SUN EXPOSURE	SETBACK FROM PAVEMENT (FEET)
<b>TREES</b>						
<i>Juglans californica</i> var. <i>californica</i>	California walnut	3-9	B, E, F	+ ^ !	FS / PS	6
<i>Quercus agrifolia</i> var. <i>agrifolia</i>	Coast live oak	1-9	A, B, C	+ ^	FS	8
<i>Sambucus nigra</i> ssp. <i>caerulea</i>	Mexican elderberry	1-9	C, E, F	+ ^ ~ o	FS	6
<i>Umbellularia californica</i>	California bay laurel	1-9	B, E, F	+ ^ !	FS / PS	6
<b>SHRUBS</b>						
<i>Amorpha fruticosa</i>	Indigobush	1-9	B, F, G	+ ~ o	FS / PS	3
<i>Artemisia californica</i>	California sagebrush	1-6, 9	A, C, D	* !	FS	3
<i>Baccharis pilularis</i> var. <i>consanguinea</i>	Coyote brush	1-5	A, C, D	* !	FS / PS	4
<i>Berberis pinnata</i>	California barberry	5-9	B, E, F	+ !	FS / PS	4
<i>Ceanothus leucodermis</i>	Chaparral whitethorn	5-9	B	+ !	FS / PS	6
<i>Ceanothus oliganthus</i>	Hairy ceanothus	1-9	A, B, C	+ !	FS	6
<i>Eriogonum fasciculatum</i> var. <i>fasciculatum</i>	California buckwheat	1-6, 9	A		FS / PS	4
<i>Eriogonum fasciculatum</i> var. <i>foliolosum</i>	Leafy California buckwheat	1-9	A, C	+ !	FS / PS	3
<i>Frangula californica</i> ssp. <i>californica</i>	California coffeeberry	1-9	A, B, C, D	* !	All	6
<i>Heteromeles arbutifolia</i>	Toyon	1-9	A, B, C, E, F	+ ^ !	FS / PS	6
<i>Isocoma menziesii</i> ssp. <i>vernonioides</i>	Goldenbush	1-9	A, C		FS / PS	2
<i>Keckiella cordifolia</i>	Heart-leaved penstemon	1-9	A, B, C, E		All	3
<i>Lepechinia fragrans</i>	Fragrant pitcher sage	3-9	A, B, C	+ * !	FS / PS	3
<i>Malosma laurina</i>	Laurel sumac	1-9	A, C	+ !	FS	6
<i>Mimulus aurantiacus</i>	Bush monkey flower	1-9	A, B, C		FS / PS	2
<i>Prunus ilicifolia</i> ssp. <i>ilicifolia</i>	Hollyleaf cherry	5-9	A, B, C	+ !	FS / PS	4
<i>Rhamnus ilicifolia</i>	Hollyleaf redberry	5-9	A, B, C	+ !	All	5
<i>Rhus aromatica</i>	Fragrant sumac	1-9	A, B, C, E, F	+	FS / PS	4
<i>Rhus integrifolia</i>	Lemonadeberry	1-9	A, B, C	+ !	FS / PS	6
<i>Rhus ovata</i>	Sugar bush	1-9	A, C	+ * !	FS / PS	6
<i>Ribes aureum</i> var. <i>gracillimum</i>	Golden currant	3-9	A, B, C, E, F		FS / PS	3
<i>Ribes californicum</i> var. <i>hesperium</i>	Hillside gooseberry	3-9	B, F, G	+	PS	4



## DESCRIPTIVE FEATURES

	PLANT FORM	WATER USE (WUCOLS IV)	MATURE HEIGHT (FEET)			MATURE WIDTH (FEET)			SHORTLIST PLANT	USACE NATIVE PLANT LIST	SEED LA TARGET LIST	OCCURRENCE IN COMMUNITY	OFTEN AVAILABLE IN CA	POLLINATOR HABITAT	BLOOM COLOR				BLOOM SEASON
			15-25	20	X	X	X	X							X	X	W	SP	
	T-D	L	15-25	20	X	X			Occasional	X	Birds	Yellow		X					
	T	VL / L	40	40	X	X			Dominant	X	Birds, Butterflies	Yellow		X					
	T-D	L	15	20	X	X			Frequent - Occasional	X	Birds, Butterflies, Bees	Yellow/Cream		X	X				
	T	L	30	30					Frequent - Occasional	X	Birds	Yellow/Cream		X					
	S-D	M	3-8	3-8					Occasional	X	Birds, Butterflies	Purple/Yellow	X	X					
	S	VL	3	2-3	X	X	X		Occasional	X	Birds, Butterflies	White + Yellow		X	X	X			
	S	L	4-6	6-8	X	X			Occasional	X	Bees, Butterflies	Yellow/Cream	X	X	X	X			
	S	L	4-6	4+					Occasional	X	Birds, Butterflies, Bees	Yellow	X	X					
	S	VL	10-12	10-20					Occasional	X	Birds, Butterflies, Bees	Blue/Lavender	X	X					
	S	(Not Listed)	8-10	8-10					Occasional	X	Birds, Butterflies, Bees	Blue/Purple	X	X					
	S/GC	VL	3	2-6		X			Occasional		Bees, Butterflies	Red/Cream			X				
	S	VL	3-5	2-6	X	X	X		Occasional	X	Birds, Butterflies, Bees	Red/Cream			X				
	S	VL	8	12	X				Frequent - Occasional	X	Birds, Butterflies, Bees	Cream		X	X				
	S/T	VL	8-15	15	X				Occasional	X	Birds, Bees	White			X				
	S	VL	1-3	3		X			Occasional	X	Bees, Butterflies	Yellow		X	X	X			
	P/V-D	VL	4	4					Occasional	X	Birds	Red		X	X				
	S	L	3-5	3-5					Occasional	X	Birds, Butterflies	Purple/Lavender		X	X	X			
	S	VL	10	20	X	X			Occasional	X	Birds	Cream	X	X					
	S	VL	2	2	X		X		Occasional	X	Birds, Butterflies, Bees	Orange/Yellow	X	X	X				
	S	VL	6-12	6-12	X				Frequent	X	Birds, Butterflies, Bees	Cream	X	X					
	S	VL	6	6	X				Frequent - Occasional	X	Birds, Butterflies, Bees	Yellow/Cream	X	X					
	S-D	L	3-5	4-8		X			Frequent - Occasional		Birds	Yellow/Cream		X					
	S	VL	8-10	15	X	X			Occasional	X	Birds	Pink	X	X					
	S	VL	8-10	15	X	X			Frequent - Occasional	X	Birds	Pink/White	X	X					
	S-D	VL	6-8	6-8	X	X	X		Frequent - Occasional	X	Birds, Butterflies, Bees	Yellow/Cream	X	X					
	S-D	L	5	5-8	X	X			Occasional	X	Birds, Butterflies, Bees	Purple/Yellow	X	X					

**SPECIES**

**SITING + PERFORMANCE**

BOTANICAL NAME	COMMON NAME	SITING + PERFORMANCE				
		FRAMES FOR BEST PERFORMANCE	CONSTRUCTED CONTEXTS	APPLICATIONS	SUN EXPOSURE	SETBACK FROM PAVEMENT (FEET)
<b>SHRUBS (continued)</b>						
<i>Ribes malvaceum</i> var. <i>viridifolium</i>	Chaparral currant	3-9	B, F	+	PS	3
<i>Ribes speciosum</i>	Fuchsia-flowered gooseberry	3-9	B, F	+	PS / FS	4
<i>Rosa californica</i>	California wild rose	1-9	E, F, G		All	3
<i>Salvia apiana</i>	White sage	3-9	A, C, D	+ !	FS	3
<i>Salvia leucophylla</i>	Purple sage	1-9	A, C, D	+ * !	FS	5
<i>Salvia mellifera</i>	Black sage	1-9	A, C, D	+ !	FS	4
<i>Venegasia carpesioides</i>	Canyon sunflower	1-9	B, E, F	+ !	All	3
<b>PERENNIALS</b>						
<i>Artemisia douglasiana</i>	Mugwort	1-9	A, B, C, E	! ~ o	All	3
<i>Asclepias eriocarpa</i>	Indian milkweed	1-9	C, E, F	+	FS	3
<i>Corethrogyne filaginifolia</i> var. <i>filaginifolia</i>	California aster	1-9	A, B		FS	2
<i>Dryopteris arguta</i>	Coastal wood fern	1-9	E, F, G	o	PS / FS	1
<i>Epilobium canum</i> ssp. <i>latifolium</i>	California fuchsia	1-9	A, B	+	FS / PS	2
<i>Eriophyllum confertiflorum</i>	Golden yarrow	1-9	A, B, C	+	FS / PS	1
<i>Eschscholzia californica</i>	California poppy	1-9	C, D		FS / PS	1
<i>Linanthus californicus</i>	Prickly phlox	1-9	A, B, E, F		FS / PS	2
<i>Lotus scaparius</i> (Acmispon <i>glaber</i> )	Deerweed	1-6, 9	A, C	+ *	FS	2
<i>Lupinus latifolius</i> var. <i>parishii</i>	Broad-leaf canyon lupine	6-9	B, E, F	+ o	FS / PS	2
<i>Penstemon centranthifolius</i>	Scarlet bugler	1-9	A, B, C, E, F	+	FS	2
<i>Penstemon heterophyllus</i> var. <i>australis</i>	Foothill penstemon	1-3; 6-9	A, B, C		FS / PS	1
<i>Penstemon spectabilis</i>	Showy penstemon	1-9	C		FS	2
<i>Sisyrinchium bellum</i>	Blue-eyed grass	1-9	E, F, G	o	FS / PS	1
<b>GRASSES</b>						
<i>Bromus carinatus</i> var. <i>carinatus</i>	California brome	1-9	A, B, C, E, F, G	* !	FS / PS	1
<i>Elymus condensatus</i>	Giant wild rye	1-9	A, B, C, E		All	2
<i>Elymus glaucus</i> ssp. <i>glaucus</i>	Blue wild rye	1-9	A, B, C, E, F, G	+	All	3
<i>Koeleria macrantha</i>	Junegrass	1-9	A, B, C, D	+ *	FS / PS	1
<i>Muhlenbergia rigens</i>	Deergrass	1-9	A, B, C, E, F		FS / PS	3

## DESCRIPTIVE FEATURES

	PLANT FORM	WATER USE (WUCOLS IV)	MATURE HEIGHT (FEET)		MATURE WIDTH (FEET)		SHORTLIST PLANT	USACE NATIVE PLANT LIST	SEED LA TARGET LIST	OCCURRENCE IN COMMUNITY	OFTEN AVAILABLE IN CA	POLLINATOR HABITAT	BLOOM COLOR				BLOOM SEASON			
			W	SP	SU	F							W	SP	SU	F				
	S-D	VL	5-8	5		X		Occasional	X	Birds, Butterflies, Bees		Pink/Purple	X	X						
	S-D	VL	5-8	6-8	X	X		Occasional	X	Birds, Butterflies, Bees		Red/Pink	X	X						
	S	L	4-6	4+	X			Frequent - Occasional	X	Birds, Butterflies, Bees		Pink		X	X					
	S	VL	3	3-5	X	X		Occasional	X	Birds, Butterflies, Bees		White	X	X	X					
	S	VL	5	6-8	X	X		Occasional	X	Birds, Butterflies, Bees		Lavender/Purple		X	X					
	S	VL	4	6	X	X	X	Occasional	X	Birds, Butterflies, Bees		Lavender/White	X	X	X					
	S	L	4	4				Occasional	X	Birds, Bees		Yellow	X	X						
	P	M	3-5	3+	X	X		Frequent	X	Birds, Butterflies		Yellow/Cream		X	X	X				
	P-D	VL	3	1+		X		Occasional	X	Birds, Butterflies		Cream/Pink			X					
	P	L	1-3	1-3	X			Frequent - Occasional	X	Birds, Butterflies, Bees		Purple/Pink/White	X							
	P	L	1-2	2+		X		Frequent												
	P	VL	1-3	2-4	X			Frequent	X	Birds, Butterflies		Red			X	X				
	P	VL	2	1-3			X	Frequent - Occasional	X	Bees, Butterflies		Yellow		X	X	X				
	A/P-D	VL	1	1-2		X		Occasional	X	Birds, Butterflies, Bees		Orange / Yellow		X						
	P	M	2	2				Occasional		Bees, Butterflies		Lavender	X	X	X					
	P	VL	3	3		X		Occasional	X	Bees, Butterflies		Yellow	X	X	X					
	P	L	4	4				Occasional	X	Bees, Butterflies		Blue/Purple		X						
	P	L	1	1-2				Occasional	X	Birds, Butterflies, Bees		Red		X	X					
	P	L	1	2				Occasional	X	Birds, Butterflies, Bees		Purple/Blue	X	X	X					
	P	L	3	3				Occasional	X	Birds		Purple/Blue/Pink	X							
	P-D	L	1	1				Frequent	X	Butterflies		Purple	X	X						
	G/P/GC	(Not Listed)	1.5-3	1+				Frequent	X	Butterflies		Yellow		X						
	G/P/GC	L	4-5	3+	X			Occasional	X	Butterflies										
	G/P/GC	L	1.5-3	1+				Frequent - Occasional	X	Butterflies										
	G/P/GC	L	1-2	1				Occasional	X	Butterflies										
	G/P/GC	L	3	4	X			Occasional	X	Birds										

**SPECIES**

**SITING + PERFORMANCE**

BOTANICAL NAME		COMMON NAME	SITING + PERFORMANCE				
			FRAMES FOR BEST PERFORMANCE	CONSTRUCTED CONTEXTS	APPLICATIONS	SUN EXPOSURE	SETBACK FROM PAVEMENT (FEET)
<b>GRASSES (continued)</b>							
<i>Poa secunda ssp. secunda (P. scabrella)</i>		One-sided bluegrass	1-9	A, B, C, E	*!	FS / PS	1
<i>Stipa cernua</i>		Nodding needlegrass	1-9	A, B, C, E		FS / PS	1
<i>Stipa lepida</i>		Foothill needlegrass	1-9	A, B, C, D		FS / PS	1
<i>Stipa pulchra</i>		Purple needlegrass	1-9	A, B, C, E	*!	FS / PS	1
<b>SUCCULENTS</b>							
<i>Yucca whipplei</i>		Our Lord's candle / chaparral yucca	5-9	A, C	+ *	FS	5
<b>VINES</b>							
<i>Clematis lasiantha</i>		Pipestems	3-9	A, B		FS / PS	2
<i>Clematis ligusticifolia</i>		Virgin's bower	3-9	B, E, F, G	o	FS / PS	2
<i>Lathyrus vestitus</i>		Pacific sweet pea	6-9	B		FS / PS	2
<i>Lathyrus vestitus var. alefeldii</i>		Showy Pacific sweet pea	6-9	B		FS / PS	2
<b>GROUNDCOVERS</b>							
<i>Achillea millefolium var. californicum</i>		Yarrow	1-9	A, B, C, D, E, F	!	FS / PS	1
<i>Carex praegracilis</i>		Slender sedge	1-9	D, E, F, G	o	FS / PS	1
<i>Salvia spathacea</i>		Hummingbird sage	1-9	B, C, E		PS / FS	2
<i>Solidago californica</i>		California goldenrod	3-9	A, B, F, G	o	FS / PS	1
<i>Solidago confinis</i>		Southern goldenrod	3-9	E, F, G	o	FS / PS	1
<i>Stachys bullata</i>		Pink hedgenettle	1-9	E, F, G	+ ~ o	PS / FS	2
<i>Symphoricarpos mollis</i>		Creeping snowberry	3-9	B, E	!	PS / FS	2



## DESCRIPTIVE FEATURES

PLANT FORM	WATER USE (WUCOLS IV)	MATURE HEIGHT (FEET)		MATURE WIDTH (FEET)		SHORTLIST PLANT	USACE NATIVE PLANT LIST	SEED LA TARGET LIST	OCCURRENCE IN COMMUNITY	OFTEN AVAILABLE IN CA	POLLINATOR HABITAT	BLOOM COLOR			
		1	2	1	2							W	SP	SU	F
G/P/GC	L	1	1				Frequent - Occasional	X	Butterflies	Yellow		X			
G/P/GC	VL	2	2				Frequent - Occasional	X							
G/P/GC	VL	2	2		X		Frequent - Occasional	X							
G/P/GC	VL	2	2		X		Frequent - Occasional	X	Butterflies	Cream		X			
SC	(Not Listed)	3	5	X		X	Occasional	X	Birds	Cream		X			
V-D	VL	climbs			X		Occasional	X		Cream		X	X		
V-D	L	climbs			X		Occasional	X		Cream			X		
V/P	(Not Listed)	climbs				X	Occasional	X		Pink/White	X	X			
V/P	(Not Listed)	climbs					Occasional			Pink/Purple	X	X			
P/GC	L	.5-2	3	X	X		Occasional	X	Birds, Butterflies, Bees	White		X	X		
P/GC	M	.5-1	2+	X			Occasional	X							
P/GC	L	1	3+	X			Occasional	X	Birds, Butterflies, Bees	Red/Pink	X	X	X		
P/GC	M	1	2+	X			Frequent - Occasional	X	Bees, Butterflies	Yellow			X	X	
P/GC	M	1	2+	X			Frequent - Occasional		Bees	Yellow		X	X	X	
P/GC	L	1-2	2+	X	X		Frequent - Occasional	X	Birds, Butterflies, Bees	Lavender/Purple		X	X	X	
S-D/GC	L	2	2+	X			Frequent - Occasional	X	Birds, Butterflies, Bees	Pink		X	X		

## SOUTHERN COTTONWOOD-WILLOW RIPARIAN FOREST

### Southern cottonwood-willow riparian forest (CWRP) (Cottonwood-Willow Association):

This water-loving community is found where soils are intermittently or seasonally saturated: riparian corridors, floodplains subject to high intensity flooding, low-gradient depositions along rivers, streams, seeps, stream and river banks, and terraces. Generally a depth to perennial ground water of not more than 10 feet is required to support this cottonwood-willow community, which may achieve either forest or woodland structure at maturity.

- Requires regularly saturated soils - typically found in areas where depth to groundwater is less than 10 feet.
- Typically found in stream beds, moist areas, or river banks and terraces.
- Can tolerate seasonal high-intensity flooding.

**Figure 226. *Populus fremontii*.** Source: CK Kelly, <https://www.inaturalist.org/photos/10765354>.

**Figure 227. *Salix laevigata*.** Source: no attribution necessary.

**Figure 228. *Salix exigua*.** Source: Thayne Tuason, <https://commons.wikimedia.org/w/index.php?curid=67414102>.

**Figure 229. *Salix lasiandra*.** Source: Matt Lavin, <https://commons.wikimedia.org/w/index.php?curid=22760167>.

**Figure 230. *Salix lasiolepis*.** Source: Par Stan Shebs, <https://commons.wikimedia.org/w/index.php?curid=7556942>.

**Figure 231. *Mimulus cardinalis*.** Source: Dcrrsr, <https://commons.wikimedia.org/w/index.php?curid=42183047>.

**Figure 232. *Juncus patens*.** Source: Daderot, <https://commons.wikimedia.org/w/index.php?curid=37530402>.

**Figure 233. *Agrostis exarata*.** Source: sarahnwilson, <https://www.inaturalist.org/photos/19749167>.

**Figure 234. *Carex praeegracilis*.** Source: Katie Hetrick, [https://commons.wikimedia.org/wiki/File:Carex\\_praeegracilis\\_-\\_Spring\\_in\\_the\\_Mary\\_Wattis\\_Brown\\_Garden\\_of\\_California\\_Native\\_Plants.jpg](https://commons.wikimedia.org/wiki/File:Carex_praeegracilis_-_Spring_in_the_Mary_Wattis_Brown_Garden_of_California_Native_Plants.jpg).



*Populus fremontii*



*Salix laevigata*



*Salix exigua*



*Salix lasiandra*



*Salix lasiolepis*



*Mimulus cardinalis*



*Juncus patens*



*Agrostis exarata*



*Carex praegracilis*



**SPECIES**

**SITING + PERFORMANCE**

BOTANICAL NAME	COMMON NAME	SITING + PERFORMANCE				
		FRAMES FOR BEST PERFORMANCE	CONSTRUCTED CONTEXTS	APPLICATIONS	SUN EXPOSURE	SETBACK FROM PAVEMENT (FEET)
<b>TREES</b>						
<i>Acer negundo</i>	Box elder	5-9	E, F, G	+ ^ ~ o	FS / PS	6
<i>Fraxinus velutina var. coriacea</i>	Velvet ash	1-9	B, E, F, G	+ ^ ! o	FS / PS	6
<i>Platanus racemosa</i>	California sycamore	1-9	E, F	+ ^ ~ o	FS	6
<i>Populus fremontii ssp. fremontii</i>	Fremont cottonwood	1-9	F, G	+ ^ ~ o	FS	8
<i>Populus trichocarpa</i>	Black cottonwood	1-9	F, G	+ ^ ~ o	FS	8
<i>Salix gooddingii</i>	Black willow	1-9	F, G	+ ^ ~ o	FS	6
<i>Salix laevigata</i>	Red willow	1-9	F, G	+ ^ ~ o	FS / PS	6
<i>Sambucus nigra ssp. caerulea</i>	Mexican elderberry	1-9	C, E, F	+ ^ ~ o	FS	6
<i>Umbellularia californica</i>	California bay laurel	1-9	B, E, F	+ ^ !	FS / PS	6
<b>SHRUBS</b>						
<i>Baccharis salicifolia</i>	Mulefat	1-9	F, G	+ ~ o	All	3
<i>Pluchea sericea</i>	Arrow weed	1-9	F, G	o	FS	3
<i>Rhus aromatica</i>	Fragrant sumac	1-9	A, B, C, E, F	+	FS / PS	4
<i>Rosa californica</i>	California wild rose	1-9	E, F, G		All	3
<i>Salix exigua</i>	Sandbar willow	2-9	F, G	+ ~ o	FS	6
<i>Salix lasiandra</i>	Shining willow	1-9	F, G	+ ^ ~ o	FS / PS	5
<i>Salix lasiolepis</i>	Arroyo willow	1-9	G	+ ^ ~ o	FS / PS	5
<b>PERENNIALS</b>						
<i>Artemisia douglasiana</i>	Mugwort	1-9	A, B, C, E	! ~ o	All	3
<i>Eriophyllum confertiflorum</i>	Golden yarrow	1-9	A, B, C	+	FS / PS	1
<i>Juncus patens</i>	California grey rush	1-9	E, F, G	~ o	FS / PS	2
<i>Juncus torreyi</i>	Rush	1-9	E, F, G	~ o	FS / PS	1-2
<i>Mimulus cardinalis</i>	Scarlet monkey flower	1-9	E, F, G	+ ~ o	All	2
<i>Thalictrum fendleri var. polycarpum</i>	Meadow rue	6-9	B, F, G	o	PS / FS	2
<b>GRASSES</b>						
<i>Agrostis exarata</i>	Bent grass	1-9	A, B, C, E, F, G		FS / PS	1-2
<i>Carex barbarae</i>	Valley sedge	1-9	F, G	~ o	FS / PS	1-2

## DESCRIPTIVE FEATURES

	PLANT FORM	WATER USE (WUCOLS IV)	MATURE HEIGHT (FEET)		MATURE WIDTH (FEET)		SHORTLIST PLANT	USACE NATIVE PLANT LIST	SEED LA TARGET LIST	OCCURRENCE IN COMMUNITY	OFTEN AVAILABLE IN CA	POLLINATOR HABITAT	BLOOM COLOR				BLOOM SEASON			
			W	SP	SU	F														
	T-D	M	30-60	40						Occasional	X	Birds, Butterflies	Yellow/Cream	X	X					
	T-D	M	20-30	20-30		X				Occasional	X	Birds, Butterflies	Yellow		X					
	T-D	M	40	40	X	X				Subdominant	X	Birds, Butterflies	Yellow/Cream	X	X					
	T-D	M	30	35						Dominant	X	Birds, Butterflies	Cream	X	X					
	T-D	M	30	30+						Frequent	X	Birds, Butterflies	Yellow	X	X					
	T-D	H	25	25						Frequent	X	Birds, Butterflies, Bees	Green	X	X					
	T-D	H	15-20	15-20						Frequent - Occasional	X	Birds, Butterflies, Bees	Yellow	X	X					
	T-D	L	15	20	X	X				Subdominant	X	Birds, Butterflies, Bees	Yellow/Cream		X	X				
	T	L	30	30						Frequent - Occasional	X	Birds	Yellow/Cream		X					
	S	H	4-8	6-10	X	X				Occasional	X	Bees, Butterflies	White/Pink/White	X	X	X	X			
	S	M	6-8	6+	X					Occasional	X		Pink		X	X				
	S-D	L	3-5	4-8		X				Frequent - Occasional		Birds	Yellow/Cream		X					
	S	L	4-6	4+	X					Frequent - Occasional	X	Birds, Butterflies, Bees	Pink		X	X				
	S-D	H	10-25	10-12	X	X				Subdominant	X	Birds, Butterflies, Bees	Yellow	X	X					
	S/T-D	H	15	15						Dominant	X	Birds, Butterflies, Bees	Yellow		X					
	S/T-D	H	15	15	X					Frequent - Occasional	X	Birds, Butterflies, Bees	Cream	X	X					
	P	M	3-5	3+	X	X				Frequent	X	Birds, Butterflies	Yellow/Cream		X	X	X			
	P	VL	2	1-3			X			Frequent - Occasional	X	Bees, Butterflies	Yellow		X	X	X			
	P/GC	L	2.5	3+	X					Frequent - Occasional	X									
	P	M	2-3	3+						Frequent - Occasional			Red/Brown				X			
	P	H	2	2			X			Occasional	X	Birds, Butterflies	Red		X	X	X			
	P	M	2	2						Occasional	X		Yellow		X	X				
	G/P/GC	(Not Listed)	2-4	2						Frequent		Butterflies								
	G/P/GC	(Not Listed)	1-3	3						Frequent	X	Butterflies	Cream/Purple/Red				X			

SOUTHERN COTTONWOOD-WILLOW RIPARIAN FOREST

**SPECIES**

**SITING + PERFORMANCE**

BOTANICAL NAME	COMMON NAME	SITING + PERFORMANCE					
		FRAMES FOR BEST PERFORMANCE	CONSTRUCTED CONTEXTS	APPLICATIONS	SUN EXPOSURE	SETBACK FROM PAVEMENT (FEET)	
<b>GRASSES (continued)</b>							
<i>Carex spissa</i>	San Diego sedge	1-9	F, G	~ o	FS	1	
<i>Elymus condensatus</i>	Giant wild rye	1-9	A, B, C, E		All	2	
<b>VINES</b>							
<i>Clematis ligusticifolia</i>	Virgin's bower	3-9	B, E, F, G	o	FS / PS	2	
<i>Vitis girdiana</i>	Desert grape	3-9	G	o	All	2	
<b>GROUNDCOVERS</b>							
<i>Carex praegracilis</i>	Slender sedge	1-9	D, E, F, G	o	FS / PS	1	
<i>Elymus triticoides</i>	Creeping wild rye	1-9	B, E, F, G	!	All	2	
<i>Euthamia occidentalis</i>	Western goldenrod	3-9	E, F, G	o	FS / PS	1	
<i>Solidago californica</i>	California goldenrod	3-9	A, B, F, G	o	FS / PS	1	
<i>Solidago confinis</i>	Southern goldenrod	3-9	E, F, G	o	FS / PS	1	



## DESCRIPTIVE FEATURES

	PLANT FORM	WATER USE (WUCOLS IV)	MATURE HEIGHT (FEET)		MATURE WIDTH (FEET)		SHORTLIST PLANT	USACE NATIVE PLANT LIST	SEED LA TARGET LIST	OCCURRENCE IN COMMUNITY	OFTEN AVAILABLE IN CA	POLLINATOR HABITAT	BLOOM COLOR				BLOOM SEASON			
			W	SP	SU	F														
	G/P/GC	M	2-4	2-4				Occasional	X	Butterflies		Brown/Green/Yellow		X						
	G/P/GC	L	4-5	3+	X			Occasional	X	Butterflies										
	V-D	L	climbs		X			Occasional	X			Cream			X					
	V/S-D	L	climbs		X			Occasional	X	Birds		Green		X						
	P/GC	M	.5-1	2+	X			Occasional	X						X	X				
	G/P/GC	L	2	2+	X			Occasional	X	Butterflies										
	P/GC	L	2-4	2+	X			Frequent - Occasional	X			Yellow / Green			X	X				
	P/GC	M	1	2+	X			Frequent - Occasional	X	Bees, Butterflies		Yellow			X	X				
	P/GC	M	1	2+	X			Frequent - Occasional		Bees		Yellow		X	X	X				

## SOUTHERN SYCAMORE RIPARIAN WOODLAND

### Southern sycamore riparian woodland (SRW) (California Sycamore Association):

This community is found along riparian corridors where soils are permanently saturated at depth. SRW is normally appropriate to braided, depositional channels of intermittent streams, gullies, springs, seeps, streams and riverbanks, and terraces adjacent to floodplains subject to high-intensity flooding. Soils supporting this community are alluvial, open, and rocky. This water-loving community should dominate river landscapes where water is available naturally.

- Will require additional water where it is not available naturally.
- Typically found in stream beds, moist areas, or north-facing slopes.
- Can tolerate seasonal high-intensity flooding.

**Figure 235. *Platanus racemosa*.** Source: Raffi Kojian, <http://www.gardenology.org>, <https://commons.wikimedia.org/w/index.php?curid=9705655>.

**Figure 236. *Fraxinus velutina* var. *coriacea*.** Source: Kenraiz, <https://commons.wikimedia.org/w/index.php?curid=75992775>.

**Figure 237. *Populus fremontii*.** Source: CK Kelly, <https://www.inaturalist.org/photos/10765354>.

**Figure 238. *Amorpha fruticosa*.** Source: Leonora (Ellie) Enking, <https://www.flickr.com/photos/33037982@N04/14428257254>.

**Figure 239. *Baccharis salicifolia*.** Source: Krzysztof Ziarnek, Kenraiz, <https://commons.wikimedia.org/w/index.php?curid=54913701>.

**Figure 240. *Rhamnus ilicifolia*.** Source: Charlie Hohn, <https://www.inaturalist.org/photos/7262866>.

**Figure 241. *Rubus ursinus*.** Source: Gaia Leo, <https://commons.wikimedia.org/w/index.php?curid=68610213>.

**Figure 242. *Thalictrum fendleri* var. *polycarpum*.** Source: Flowersinmyyard, <https://commons.wikimedia.org/w/index.php?curid=68320295>.

**Figure 243. *Elymus condensatus*.** Source: Peggy A. Lopipero-Langmo, <https://www.flickr.com/photos/98699202@N03/10355498513>.



*Platanus racemosa*



*Fraxinus velutina var. coriacea*



*Populus fremontii*



*Amorpha fruticosa*



*Baccharis salicifolia*



*Rhamnus ilicifolia*



*Rubus ursinus*



*Thalictrum fendleri var. polycarpum*



*Elymus condensatus*



**SPECIES**

**SITING + PERFORMANCE**

BOTANICAL NAME	COMMON NAME	SITING + PERFORMANCE				
		FRAMES FOR BEST PERFORMANCE	CONSTRUCTED CONTEXTS	APPLICATIONS	SUN EXPOSURE	SETBACK FROM PAVEMENT (FEET)
<b>TREES</b>						
<i>Acer negundo</i>	Box elder	5-9	E, F, G	+ ^ ~ o	FS / PS	6
<i>Alnus rhombifolia</i>	White alder	1-9	G	+ ^ ~ o	All	6
<i>Fraxinus velutina</i> var. <i>coriacea</i>	Velvet ash	1-9	B, E, F, G	+ ^ ! o	FS / PS	6
<i>Juglans californica</i> var. <i>californica</i>	California walnut	3-9	B, E, F	+ ^ !	FS / PS	6
<i>Platanus racemosa</i>	California sycamore	1-9	E, F	+ ^ ~ o	FS	6
<i>Populus fremontii</i> ssp. <i>fremontii</i>	Fremont cottonwood	1-9	F, G	+ ^ ~ o	FS	8
<i>Populus trichocarpa</i>	Black cottonwood	1-9	F, G	+ ^ ~ o	FS	8
<i>Quercus agrifolia</i> var. <i>agrifolia</i>	Coast live oak	1-9	A, B, C	+ ^	FS	8
<i>Salix gooddingii</i>	Black willow	1-9	F, G	+ ^ ~ o	FS	6
<i>Sambucus nigra</i> ssp. <i>caerulea</i>	Mexican elderberry	1-9	C, E, F	+ ^ ~ o	FS	6
<i>Umbellularia californica</i>	California bay laurel	1-9	B, E, F	+ ^ !	FS / PS	6
<b>SHRUBS</b>						
<i>Amorpha fruticosa</i>	Indigobush	1-9	B, F, G	+ ~ o	FS / PS	3
<i>Baccharis pilularis</i> var. <i>consanguinea</i>	Coyote brush	1-5	A, C, D	* !	FS / PS	4
<i>Baccharis salicifolia</i>	Mulefat	1-9	F, G	+ ~ o	All	3
<i>Berberis pinnata</i>	California barberry	5-9	B, E, F	+ !	FS / PS	4
<i>Frangula californica</i> ssp. <i>californica</i>	California coffeeberry	1-9	A, B, C, D	* !	All	6
<i>Heteromeles arbutifolia</i>	Toyon	1-9	A, B, C, E, F	+ ^ !	FS / PS	6
<i>Keckiella cordifolia</i>	Heart-leaved penstemon	1-9	A, B, C, E		All	3
<i>Malosma laurina</i>	Laurel sumac	1-9	A, C	+ !	FS	6
<i>Mimulus aurantiacus</i>	Bush monkey flower	1-9	A, B, C		FS / PS	2
<i>Pluchea sericea</i>	Arrow weed	1-9	F, G	o	FS	3
<i>Prunus ilicifolia</i> ssp. <i>ilicifolia</i>	Hollyleaf cherry	5-9	A, B, C	+ !	FS / PS	4
<i>Rhamnus ilicifolia</i>	Hollyleaf redberry	5-9	A, B, C	+ !	All	5
<i>Rhus aromatica</i>	Fragrant sumac	1-9	A, B, C, E, F	+	FS / PS	4
<i>Rhus integrifolia</i>	Lemonadeberry	1-9	A, B, C	+ !	FS / PS	6
<i>Ribes aureum</i> var. <i>gracillimum</i>	Golden currant	3-9	A, B, C, E, F		FS / PS	3
<i>Ribes californicum</i> var. <i>hesperium</i>	Hillside gooseberry	3-9	B, F, G	+	PS	4

## DESCRIPTIVE FEATURES

	PLANT FORM	WATER USE (WUCOLS IV)	MATURE HEIGHT (FEET)		MATURE WIDTH (FEET)		SHORTLIST PLANT	USACE NATIVE PLANT LIST	SEED LA TARGET LIST	OCCURRENCE IN COMMUNITY	OFTEN AVAILABLE IN CA	POLLINATOR HABITAT	BLOOM COLOR				BLOOM SEASON			
			W	SP	SU	F														
	T-D	M	30-60	40				Occasional	X	Birds, Butterflies	Yellow/Cream	X	X							
	T-D	H	20-30	20-30	X			Occasional	X	Birds, Butterflies	Green / Cream			X	X					
	T-D	M	20-30	20-30		X		Frequent - Occasional	X	Birds, Butterflies	Yellow		X							
	T-D	L	15-25	20	X	X		Frequent	X	Birds	Yellow		X							
	T-D	M	40	40	X	X		Dominant	X	Birds, Butterflies	Yellow/Cream	X	X							
	T-D	M	30	35				Occasional	X	Birds, Butterflies	Cream	X	X							
	T-D	M	30	30+				Frequent - Occasional	X	Birds, Butterflies	Yellow	X	X							
	T	VL / L	40	40	X	X		Occasional	X	Birds, Butterflies	Yellow		X							
	T-D	H	25	25				Frequent	X	Birds, Butterflies, Bees	Green	X	X							
	T-D	L	15	20	X	X		Subdominant	X	Birds, Butterflies, Bees	Yellow/Cream		X	X						
	T	L	30	30				Frequent - Occasional	X	Birds	Yellow/Cream		X							
	S-D	M	3-8	3-8				Frequent - Occasional	X	Birds, Butterflies	Purple/Yellow	X	X							
	S	L	4-6	6-8	X	X		Frequent	X	Bees, Butterflies	Yellow/Cream	X	X	X	X					
	S	H	4-8	6-10	X	X		Frequent	X	Bees, Butterflies	White/Pink/White	X	X	X	X					
	S	L	4-6	4+				Occasional	X	Birds, Butterflies, Bees	Yellow	X	X							
	S	VL	8	12	X			Frequent - Occasional	X	Birds, Butterflies, Bees	Cream		X	X						
	S/T	VL	8-15	15	X			Occasional	X	Birds, Bees	White			X						
	P/V-D	VL	4	4				Occasional	X	Birds	Red		X	X						
	S	VL	10	20	X	X		Frequent	X	Birds	Cream	X	X							
	S	VL	2	2	X		X	Frequent	X	Birds, Butterflies, Bees	Orange/Yellow	X	X	X						
	S	M	6-8	6+	X			Occasional	X		Pink		X	X						
	S	VL	6-12	6-12	X			Occasional	X	Birds, Butterflies, Bees	Cream	X	X							
	S	VL	6	6	X			Frequent - Occasional	X	Birds, Butterflies, Bees	Yellow/Cream	X	X							
	S-D	L	3-5	4-8		X		Frequent - Occasional		Birds	Yellow/Cream		X							
	S	VL	8-10	15	X	X		Occasional	X	Birds	Pink	X	X							
	S-D	VL	6-8	6-8	X	X	X	Frequent - Occasional	X	Birds, Butterflies, Bees	Yellow/Cream	X	X							
	S-D	L	5	5-8	X	X		Occasional	X	Birds, Butterflies, Bees	Purple/Yellow	X	X							

**SPECIES**

**SITING + PERFORMANCE**

BOTANICAL NAME	COMMON NAME	SITING + PERFORMANCE				
		FRAMES FOR BEST PERFORMANCE	CONSTRUCTED CONTEXTS	APPLICATIONS	SUN EXPOSURE	SETBACK FROM PAVEMENT (FEET)
<b>SHRUBS (continued)</b>						
<i>Ribes speciosum</i>	Fuchsia-flowered gooseberry	3-9	B, F	+	PS / FS	4
<i>Rosa californica</i>	California wild rose	1-9	E, F, G		All	3
<i>Salix exigua</i>	Sandbar willow	2-9	F, G	+ ~ 0	FS	6
<i>Salix lasiolepis</i>	Arroyo willow	1-9	G	+ ^ ~ 0	FS / PS	5
<i>Venegasia carpesioides</i>	Canyon sunflower	1-9	B, E, F	+ !	All	3
<b>PERENNIALS</b>						
<i>Artemisia douglasiana</i>	Mugwort	1-9	A, B, C, E	! ~ 0	All	3
<i>Eriophyllum confertiflorum</i>	Golden yarrow	1-9	A, B, C	+	FS / PS	1
<i>Eschscholzia californica</i>	California poppy	1-9	C, D		FS / PS	1
<i>Juncus patens</i>	California grey rush	1-9	E, F, G	~ 0	FS / PS	2
<i>Juncus textilis</i>	Basket rush	1-9	E, F, G	+ ~ 0	FS	2
<i>Juncus torreyi</i>	Rush	1-9	E, F, G	~ 0	FS / PS	1-2
<i>Lotus scoparius (Acmispon glaber)</i>	Deerweed	1-6, 9	A, C	+ *	FS	2
<i>Lupinus latifolius var. parishii</i>	Broad-leaf canyon lupine	6-9	B, E, F	+ 0	FS / PS	2
<i>Thalictrum fendleri var. polycarpum</i>	Meadow rue	6-9	B, F, G	0	PS / FS	2
<i>Typha domingensis</i>	Southern cattail	1-9	E, F, G	~ 0	FS	2
<b>GRASSES</b>						
<i>Agrostis exarata</i>	Bent grass	1-9	A, B, C, E, F, G		FS / PS	1-2
<i>Bromus carinatus var. carinatus</i>	California brome	1-9	A, B, C, E, F, G	* !	FS / PS	1
<i>Carex barbarae</i>	Valley sedge	1-9	F, G	~ 0	FS / PS	1-2
<i>Carex spissa</i>	San Diego sedge	1-9	F, G	~ 0	FS	1
<i>Elymus condensatus</i>	Giant wild rye	1-9	A, B, C, E		All	2
<i>Muhlenbergia rigens</i>	Deergrass	1-9	A, B, C, E, F		FS / PS	3
<i>Schoenoplectus acutus var. occidentalis</i>	Tule	5-9	E, F, G	~ 0	FS	2
<b>VINES</b>						
<i>Clematis ligusticifolia</i>	Virgin's bower	3-9	B, E, F, G	0	FS / PS	2
<i>Vitis girdiana</i>	Desert grape	3-9	G	0	All	2



## DESCRIPTIVE FEATURES

	PLANT FORM	WATER USE (WUCOLS IV)	MATURE HEIGHT (FEET)		MATURE WIDTH (FEET)		SHORTLIST PLANT	USACE NATIVE PLANT LIST	SEED LA TARGET LIST	OCCURRENCE IN COMMUNITY	OFTEN AVAILABLE IN CA	POLLINATOR HABITAT	BLOOM COLOR				BLOOM SEASON			
			W	SP	SU	F														
	S-D	VL	5-8	6-8	X	X		Occasional	X	Birds, Butterflies, Bees	Red/Pink	X	X							
	S	L	4-6	4+	X			Frequent - Occasional	X	Birds, Butterflies, Bees	Pink		X	X						
	S-D	H	10-25	10-12	X	X		Frequent - Occasional	X	Birds, Butterflies, Bees	Yellow	X	X							
	S/T-D	H	15	15	X			Frequent - Occasional	X	Birds, Butterflies, Bees	Cream	X	X							
	S	L	4	4				Occasional	X	Birds, Bees	Yellow	X	X							
	P	M	3-5	3+	X	X		Frequent	X	Birds, Butterflies	Yellow/Cream		X	X	X					
	P	VL	2	1-3			X	Frequent - Occasional	X	Bees, Butterflies	Yellow		X	X	X					
	A/P-D	VL	1	1-2		X		Occasional	X	Birds, Butterflies, Bees	Orange / Yellow		X							
	P/GC	L	2.5	3+	X			Occasional	X	Butterflies										
	P	M	3-7	1				Occasional	X											
	P	M	2-3	3+				Occasional			Red/Brown				X					
	P	VL	3	3		X		Occasional	X	Bees, Butterflies	Yellow	X	X	X						
	P	L	4	4				Occasional	X	Bees, Butterflies	Blue/Purple		X							
	P	M	2	2				Occasional	X		Yellow		X	X						
	P	(Not Listed)	12	3+				Occasional	X	Butterflies										
	G/P/GC	(Not Listed)	2-4	2				Frequent		Butterflies										
	G/P/GC	(Not Listed)	1.5-3	1+				Frequent	X	Butterflies	Yellow		X							
	G/P/GC	(Not Listed)	1-3	3				Frequent	X	Butterflies	Cream/Purple/Red				X					
	G/P/GC	M	2-4	2-4				Occasional	X	Butterflies	Brown/Green/Yellow		X							
	G/P/GC	L	4-5	3+	X			Occasional	X	Butterflies										
	G/P/GC	L	3	4	X			Occasional	X	Birds										
	G/P/GC	(Not Listed)	3-10	3+				Frequent - Occasional		Butterflies										
	V-D	L	climbs		X			Occasional	X		Cream				X					
	V/S-D	L	climbs		X			Occasional	X	Birds	Green		X							

SOUTHERN SYCAMORE RIPARIAN WOODLAND

**SPECIES**

**SITING + PERFORMANCE**

BOTANICAL NAME	COMMON NAME	SITING + PERFORMANCE					
		FRAMES FOR BEST PERFORMANCE	CONSTRUCTED CONTEXTS	APPLICATIONS	SUN EXPOSURE	SETBACK FROM PAVEMENT (FEET)	
<b>GROUNDCOVERS</b>							
<i>Carex praegracilis</i>	Slender sedge	1-9	D, E, F, G	○	FS / PS	1	
<i>Euthamia occidentalis</i>	Western goldenrod	3-9	E, F, G	○	FS / PS	1	
<i>Elymus triticoides</i>	Creeping wild rye	1-9	B, E, F, G	!	All	2	
<i>Salvia spathacea</i>	Hummingbird sage	1-9	B, C, E		PS / FS	2	
<i>Solidago californica</i>	California goldenrod	3-9	A, B, F, G	○	FS / PS	1	
<i>Solidago confinis</i>	Southern goldenrod	3-9	E, F, G	○	FS / PS	1	
<i>Stachys bullata</i>	Pink hedgenettle	1-9	E, F, G	+ ~ ○	PS / FS	2	
<i>Symphoricarpos mollis</i>	Creeping snowberry	3-9	B, E	!	PS / FS	2	



## VALLEY OAK WOODLAND

### Valley oak woodland (VOW) (Valley Oak Association):

This community is typified by its majestic signature tree (*Quercus lobata*), limited shrub layer, and generally grassy understory. VOW occurs in deep, well-drained alluvial soils that may be intermittently or seasonally flooded. This community is found on floodplains, valley bottoms, gentle slopes, and summit valleys.

- Understory is adapted to partial or full shade.
- Requires well draining soils that may be seasonally flooded.
- Typically found in stream beds, floodplain, or gentle slopes.

**Figure 244. *Quercus lobata*.** Source: King of Hearts, <https://commons.wikimedia.org/w/index.php?curid=75700289>.

**Figure 245. *Platanus racemosa*.** Source: Raffi Kojian, <http://www.gardenology.org>, <https://commons.wikimedia.org/w/index.php?curid=9705655>.

**Figure 246. *Frangula californica ssp. californica*.** Source: Krzysztof Ziarnek, Kenraiz, <https://commons.wikimedia.org/w/index.php?curid=54696941>.

**Figure 247. *Eriophyllum confertiflorum*.** Source: Björn S..., <https://www.flickr.com/photos/40948266@N04/43163438812>.

**Figure 248. *Sisyrinchium bellum*.** Source: Franco Folini, <https://www.flickr.com/photos/livenature/4350730696>.

**Figure 249. *Eschscholzia californica*.** Source: docentjoyce, <https://commons.wikimedia.org/w/index.php?curid=8495738>.

**Figure 250. *Vitis girdiana*** Source: Stickpen, <https://commons.wikimedia.org/wiki/File:Vitisgirdiana1.JPG>.

**Figure 251. *Stipa cernua*.** Source: Kyle Nessen, <https://www.inaturalist.org/photos/38751036>.

**Figure 252. *Stipa pulchra*.** Source: Matt Lavin, [https://www.flickr.com/photos/plant\\_diversity/35034340452](https://www.flickr.com/photos/plant_diversity/35034340452).





*Quercus lobata*



*Platanus racemosa*



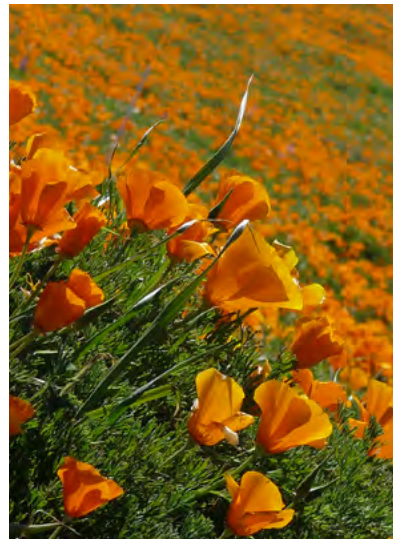
*Frangula californica* ssp. *californica*



*Eriophyllum confertiflorum*



*Sisyrrinchium bellum*



*Eschscholzia californica*



*Vitis girdiana*



*Stipa cernua*



*Stipa pulchra*

**SPECIES**

**SITING + PERFORMANCE**

BOTANICAL NAME	COMMON NAME	SITING + PERFORMANCE					
		FRAMES FOR BEST PERFORMANCE	CONSTRUCTED CONTEXTS	APPLICATIONS	SUN EXPOSURE	SETBACK FROM PAVEMENT (FEET)	
<b>TREES</b>							
<i>Fraxinus velutina</i> var. <i>coriacea</i>	Velvet ash	1-9	B, E, F, G	+ ^ ! o	FS / PS	6	
<i>Platanus racemosa</i>	California sycamore	1-9	E, F	+ ^ ~ o	FS	6	
<i>Quercus agrifolia</i> var. <i>agrifolia</i>	Coast live oak	1-9	A, B, C	+ ^	FS	8	
<i>Quercus lobata</i>	Valley oak	3-6	A, C, E	+ ^ *	FS	8	
<b>SHRUBS</b>							
<i>Frangula californica</i> ssp. <i>californica</i>	California coffeeberry	1-9	A, B, C, D	* !	All	6	
<b>PERENNIALS</b>							
<i>Corethrogyne filaginifolia</i> var. <i>filaginifolia</i>	California aster	1-9	A, B		FS	2	
<i>Eriophyllum confertiflorum</i>	Golden yarrow	1-9	A, B, C	+	FS / PS	1	
<i>Eschscholzia californica</i>	California poppy	1-9	C, D		FS / PS	1	
<i>Sisyrinchium bellum</i>	Blue-eyed grass	1-9	E, F, G	o	FS / PS	1	
<b>GRASSES</b>							
<i>Bromus carinatus</i> var. <i>carinatus</i>	California brome	1-9	A, B, C, E, F, G	* !	FS / PS	1	
<i>Elymus condensatus</i>	Giant wild rye	1-9	A, B, C, E		All	2	
<i>Muhlenbergia rigens</i>	Deergrass	1-9	A, B, C, E, F		FS / PS	3	
<i>Stipa cernua</i>	Nodding needlegrass	1-9	A, B, C, E		FS / PS	1	
<i>Stipa pulchra</i>	Purple needlegrass	1-9	A, B, C, E	* !	FS / PS	1	
<b>VINES</b>							
<i>Clematis ligusticifolia</i>	Virgin's bower	3-9	B, E, F, G	o	FS / PS	2	
<i>Lathyrus vestitus</i>	Pacific sweet pea	6-9	B		FS / PS	2	
<i>Vitis girdiana</i>	Desert grape	3-9	G	o	All	2	
<b>GROUNDCOVERS</b>							
<i>Achillea millefolium</i> var. <i>californicum</i>	Yarrow	1-9	A, B, C, D, E, F	!	FS / PS	1	
<i>Carex praegracilis</i>	Slender sedge	1-9	D, E, F, G	o	FS / PS	1	
<i>Elymus triticoides</i>	Creeping wild rye	1-9	B, E, F, G	!	All	2	
<i>Euthamia occidentalis</i>	Western goldenrod	3-9	E, F, G	o	FS / PS	1	
<i>Solidago californica</i>	California goldenrod	3-9	A, B, F, G	o	FS / PS	1	
<i>Solidago confinis</i>	Southern goldenrod	3-9	E, F, G	o	FS / PS	1	



## DESCRIPTIVE FEATURES

	PLANT FORM	WATER USE (WUCOLS IV)	MATURE HEIGHT (FEET)		MATURE WIDTH (FEET)		SHORTLIST PLANT	USACE NATIVE PLANT LIST	SEED LA TARGET LIST	OCCURRENCE IN COMMUNITY	OFTEN AVAILABLE IN CA	POLLINATOR HABITAT	BLOOM COLOR				BLOOM SEASON			
			W	SP	SU	F														
T-D	M	20-30	20-30		X		Occasional	X	Birds, Butterflies	Yellow		X								
T-D	M	40	40	X	X		Subdominant	X	Birds, Butterflies	Yellow/Cream	X	X								
T	VL / L	40	40	X	X		Occasional	X	Birds, Butterflies	Yellow		X								
T-D	M	35	35	X	X		Dominant	X	Birds, Butterflies	Green / Cream	X	X								
S	VL	8	12	X			Frequent - Occasional	X	Birds, Butterflies, Bees	Cream		X	X							
P	L	1-3	1-3	X			Frequent - Occasional	X	Birds, Butterflies, Bees	Purple/Pink/White	X									
P	VL	2	1-3			X	Frequent - Occasional	X	Bees, Butterflies	Yellow		X	X	X						
A/P-D	VL	1	1-2		X		Occasional	X	Birds, Butterflies, Bees	Orange / Yellow		X								
P-D	L	1	1				Frequent	X	Butterflies	Purple	X	X								
G/P/GC	(Not Listed)	1.5-3	1+				Frequent	X	Butterflies	Yellow		X								
G/P/GC	L	4-5	3+	X			Occasional	X	Butterflies											
G/P/GC	L	3	4	X			Frequent	X	Birds											
G/P/GC	VL	2	2				Frequent	X												
G/P/GC	VL	2	2		X		Frequent	X	Butterflies	Cream		X								
V-D	L	climbs			X		Occasional	X		Cream							X			
V/P	(Not Listed)	climbs				X	Occasional	X		Pink/White	X	X								
V/S-D	L	climbs			X		Occasional	X	Birds	Green		X								
P/GC	L	.5-2	3	X	X		Occasional	X	Birds, Butterflies, Bees	White		X	X							
P/GC	M	.5-1	2+	X			Occasional	X												
G/P/GC	L	2	2+	X			Occasional	X	Butterflies											
P/GC	L	2-4	2+	X			Frequent - Occasional	X		Yellow / Green				X	X					
P/GC	M	1	2+	X			Frequent - Occasional	X	Bees, Butterflies	Yellow				X	X					
P/GC	M	1	2+	X			Frequent - Occasional		Bees	Yellow		X	X	X						

## CALIFORNIA WALNUT WOODLAND

### California walnut woodland (WW) (Walnut Woodland Association):

Walnut woodlands are found where soils are intermittently flooded and saturated, such as riparian corridors, floodplains, incised canyons, low-flow river and stream margins, seeps, stream and river banks, and terraces. WW also favor rarely flooded north-facing slopes, terraces, and flats. Its soils are generally fine-textured, shale-derived, and deep.

- Very rare in LA River watershed due to urbanization.
- Requires well draining soils that may be seasonally flooded.
- Typically found in stream beds, moist areas, or north-facing slopes.

**Figure 253. *Juglans californica*.** Source: Consultaplantas, <https://commons.wikimedia.org/w/index.php?curid=44978241>.

**Figure 254. *Sambucus nigra* ssp. *caerulea*.** Source: Stan Shebs, <https://commons.wikimedia.org/w/index.php?curid=1953423>.

**Figure 255. *Heteromeles arbutifolia*.** Source: Miguel Vieira, <https://commons.wikimedia.org/w/index.php?curid=19525268>.

**Figure 256. *Salvia leucophylla*.** Source: John Rusk, [https://www.flickr.com/photos/john\\_d\\_rusk/9309081263](https://www.flickr.com/photos/john_d_rusk/9309081263).

**Figure 257. *Malacothamnus fasciculatus*.** Source: Stan Shebs, <https://commons.wikimedia.org/w/index.php?curid=1113761>.

**Figure 258. *Asclepias fascicularis*.** Source: Jim Morefield, <https://www.flickr.com/photos/127605180@N04/15966683860>.

**Figure 259. *Achillea millefolium* var. *californicum*.** Source: Dcrjrs, <https://commons.wikimedia.org/w/index.php?curid=16059528>.

**Figure 260. *Calystegia macrostegia* ssp. *arida*.** Source: OLIN, 2017.

**Figure 261. *Solidago californica*.** Source: Stickpen, <https://commons.wikimedia.org/w/index.php?curid=8092464>.





*Juglans californica*



*Sambucus nigra ssp. caerulea*



*Heteromeles arbutifolia*



*Salvia leucophylla*



*Malacothamnus fasciculatus*



*Asclepias fascicularis*



*Achillea millefolium var. californicum*



*Calystegia macrostegia ssp. arida*



*Solidago californica*

**SPECIES**

**SITING + PERFORMANCE**

BOTANICAL NAME	COMMON NAME	SITING + PERFORMANCE					
		FRAMES FOR BEST PERFORMANCE	CONSTRUCTED CONTEXTS	APPLICATIONS	SUN EXPOSURE	SETBACK FROM PAVEMENT (FEET)	
<b>TREES</b>							
<i>Juglans californica</i> var. <i>californica</i>	California walnut	3-9	B, E, F	+ ^ !	FS / PS	6	
<i>Quercus agrifolia</i> var. <i>agrifolia</i>	Coast live oak	1-9	A, B, C	+ ^	FS	8	
<i>Sambucus nigra</i> ssp. <i>caerulea</i>	Mexican elderberry	1-9	C, E, F	+ ^ ~ o	FS	6	
<b>SHRUBS</b>							
<i>Heteromeles arbutifolia</i>	Toyon	1-9	A, B, C, E, F	+ ^ !	FS / PS	6	
<i>Lonicera subspicata</i> var. <i>denudata</i>	Chaparral honeysuckle	1-9	A, B		FS	2	
<i>Malacothamnus fasciculatus</i>	Chaparral bush mallow	1-9	A	+ !	FS	4	
<i>Mimulus aurantiacus</i>	Bush monkey flower	1-9	A, B, C		FS / PS	2	
<i>Prunus ilicifolia</i> ssp. <i>ilicifolia</i>	Hollyleaf cherry	5-9	A, B, C	+ !	FS / PS	4	
<i>Rhamnus ilicifolia</i>	Hollyleaf redberry	5-9	A, B, C	+ !	All	5	
<i>Rhus ovata</i>	Sugar bush	1-9	A, C	+ * !	FS / PS	6	
<i>Ribes aureum</i> var. <i>gracillimum</i>	Golden currant	3-9	A, B, C, E, F		FS / PS	3	
<i>Salvia leucophylla</i>	Purple sage	1-9	A, C, D	+ * !	FS	5	
<i>Salvia mellifera</i>	Black sage	1-9	A, C, D	+ !	FS	4	
<b>PERENNIALS</b>							
<i>Asclepias fascicularis</i>	Narrow-leaved milkweed	1-9	C, E, F, G	+	FS / PS	3	
<i>Corethrogyne filaginifolia</i> var. <i>filaginifolia</i>	California aster	1-9	A, B		FS	2	
<i>Dryopteris arguta</i>	Coastal wood fern	1-9	E, F, G	o	PS / FS	1	
<i>Eriophyllum confertiflorum</i>	Golden yarrow	1-9	A, B, C	+	FS / PS	1	
<i>Eschscholzia californica</i>	California poppy	1-9	C, D		FS / PS	1	
<i>Malacothrix saxatilis</i>	Cliff aster	1-9	A, B, C, D	+	FS	1	
<i>Sisyrinchium bellum</i>	Blue-eyed grass	1-9	E, F, G	o	FS / PS	1	
<i>Thalictrum fendleri</i> var. <i>polycarpum</i>	Meadow rue	6-9	B, F, G	o	PS / FS	2	
<b>GRASSES</b>							
<i>Bromus carinatus</i> var. <i>carinatus</i>	California brome	1-9	A, B, C, E, F, G	* !	FS / PS	1	
<i>Elymus condensatus</i>	Giant wild rye	1-9	A, B, C, E		All	2	
<i>Elymus glaucus</i> ssp. <i>glaucus</i>	Blue wild rye	1-9	A, B, C, E, F, G	+	All	3	



## DESCRIPTIVE FEATURES

	PLANT FORM	WATER USE (WUCOLS IV)	MATURE HEIGHT (FEET)		MATURE WIDTH (FEET)		SHORTLIST PLANT	USACE NATIVE PLANT LIST	SEED LA TARGET LIST	OCCURRENCE IN COMMUNITY	OFTEN AVAILABLE IN CA	POLLINATOR HABITAT	BLOOM COLOR				BLOOM SEASON
			W	SP	SU	F											
	T-D	L	15-25	20	X	X		Dominant	X	Birds	Yellow		X				
	T	VL / L	40	40	X	X		Subdominant	X	Birds, Butterflies	Yellow		X				
	T-D	L	15	20	X	X		Frequent - Occasional	X	Birds, Butterflies, Bees	Yellow/Cream		X	X			
	S/T	VL	8-15	15	X			Subdominant	X	Birds, Bees	White				X		
	V/S	L	climbs					Occasional	X	Birds	Yellow/Cream		X	X			
	S	VL	6	6+		X		Frequent - Occasional	X	Birds, Butterflies	White + Pink		X	X			
	S	VL	2	2	X		X	Frequent	X	Birds, Butterflies, Bees	Orange/Yellow	X	X	X			
	S	VL	6-12	6-12	X			Frequent	X	Birds, Butterflies, Bees	Cream	X	X				
	S	VL	6	6	X			Frequent - Occasional	X	Birds, Butterflies, Bees	Yellow/Cream	X	X				
	S	VL	8-10	15	X	X		Frequent - Occasional	X	Birds	Pink/White	X	X				
	S-D	VL	6-8	6-8	X	X	X	Frequent - Occasional	X	Birds, Butterflies, Bees	Yellow/Cream	X	X				
	S	VL	5	6-8	X	X		Occasional	X	Birds, Butterflies, Bees	Lavender/Purple		X	X			
	S	VL	4	6	X	X	X	Occasional	X	Birds, Butterflies, Bees	Lavender/White	X	X	X			
	P-D	VL	3	2+		X		Occasional	X	Birds, Butterflies	White, Lavender				X	X	
	P	L	1-3	1-3	X			Frequent - Occasional	X	Birds, Butterflies, Bees	Purple/Pink/White	X					
	P	L	1-2	2+		X		Occasional									
	P	VL	2	1-3			X	Frequent - Occasional	X	Bees, Butterflies	Yellow		X	X	X		
	A/P-D	VL	1	1-2		X		Occasional	X	Birds, Butterflies, Bees	Orange / Yellow		X				
	P	M	1-2	1-2				Occasional		Bees, Butterflies	White	X		X	X		
	P-D	L	1	1				Frequent	X	Butterflies	Purple	X	X				
	P	M	2	2				Occasional	X		Yellow		X	X			
	G/P/GC	(Not Listed)	1.5-3	1+				Occasional	X	Butterflies	Yellow		X				
	G/P/GC	L	4-5	3+	X			Occasional	X	Butterflies							
	G/P/GC	L	1.5-3	1+				Frequent - Occasional	X	Butterflies							

**SPECIES**

**SITING + PERFORMANCE**

BOTANICAL NAME	COMMON NAME	SITING + PERFORMANCE				
		FRAMES FOR BEST PERFORMANCE	CONSTRUCTED CONTEXTS	APPLICATIONS	SUN EXPOSURE	SETBACK FROM PAVEMENT (FEET)
<b>GRASSES (continued)</b>						
<i>Stipa lepida</i>	Foothill needlegrass	1-9	A, B, C, D		FS / PS	1
<i>Stipa pulchra</i>	Purple needlegrass	1-9	A, B, C, E	* !	FS / PS	1
<b>SUCCULENTS</b>						
<i>Opuntia littoralis</i>	Coastal prickly pear	1-9	A		FS	3
<b>VINES</b>						
<i>Calystegia macrostegia ssp. arida</i>	Southern California morning glory	3-9	B		FS / PS	1
<i>Calystegia macrostegia ssp. intermedia</i>	Island morning glory	1-5	A, B		FS / PS	1
<i>Clematis ligusticifolia</i>	Virgin's bower	3-9	B, E, F, G	o	FS / PS	2
<b>GROUNDCOVERS</b>						
<i>Achillea millefolium var. californicum</i>	Yarrow	1-9	A, B, C, D, E, F	!	FS / PS	1
<i>Carex praegracilis</i>	Slender sedge	1-9	D, E, F, G	o	FS / PS	1
<i>Elymus triticoides</i>	Creeping wild rye	1-9	B, E, F, G	!	All	2
<i>Euthamia occidentalis</i>	Western goldenrod	3-9	E, F, G	o	FS / PS	1
<i>Solidago californica</i>	California goldenrod	3-9	A, B, F, G	o	FS / PS	1
<i>Solidago confinis</i>	Southern goldenrod	3-9	E, F, G	o	FS / PS	1
<i>Symphoricarpos mollis</i>	Creeping snowberry	3-9	B, E	!	PS / FS	2



## DESCRIPTIVE FEATURES

	PLANT FORM	WATER USE (WUCOLS IV)	MATURE HEIGHT (FEET)		MATURE WIDTH (FEET)		SHORTLIST PLANT	USACE NATIVE PLANT LIST	SEED LA TARGET LIST	OCCURRENCE IN COMMUNITY	OFTEN AVAILABLE IN CA	POLLINATOR HABITAT	BLOOM COLOR				BLOOM SEASON			
			W	SP	SU	F							W	SP	SU	F				
	G/P/GC	VL	2	2		X		Occasional	X											
	G/P/GC	VL	2	2		X		Occasional	X	Butterflies		Cream		X						
	SC	VL	3	3+		X		Frequent - Occasional	X	Birds		Orange / Yellow		X						
	V/P	L	climbs			X		Frequent - Occasional		Bees		White	X	X	X					
	V/P	L	climbs			X	X	Frequent - Occasional	X	Bees		Pink/White	X	X	X					
	V-D	L	climbs			X		Occasional	X			Cream			X					
	P/GC	L	.5-2	3	X	X		Occasional	X	Birds, Butterflies, Bees		White		X	X					
	P/GC	M	.5-1	2+	X			Occasional	X											
	G/P/GC	L	2	2+	X			Occasional	X	Butterflies										
	P/GC	L	2-4	2+	X			Frequent - Occasional	X			Yellow / Green			X	X				
	P/GC	M	1	2+	X			Frequent - Occasional	X	Bees, Butterflies		Yellow			X	X				
	P/GC	M	1	2+	X			Frequent - Occasional		Bees		Yellow		X	X	X				
	S-D/GC	L	2	2+	X			Frequent - Occasional	X	Birds, Butterflies, Bees		Pink		X	X					

## PERENNIAL FRESHWATER EMERGENT WETLAND

### Perennial freshwater emergent wetland (PFEW):

This community thrives in lowland areas distinguished by year-round saturated soils and shallow standing water. Historically, such areas appeared along the path of former channels within the floodplain, but 90% of this habitat type in California has since been destroyed. Herbaceous plants such as grasses, reeds, sedges, rushes, cattails, and bulrush predominate. Many of these are rhizomatous, reproducing asexually underground rather than by seed. The herbaceous vegetation tends to appear in dense clumps, with trees and shrubs accounting for less than 10% of plant cover. Soils are deep, built up from sediment deposition by slow-moving waters, and can be peaty.

- Requires saturated soils or shallow standing water.
- Typically found along the margins of lakes and reservoirs.
- Restoration efforts are needed.

**Figure 262. *Salix exigua*.** Source: Thayne Tuason, [https://commons.wikimedia.org/wiki/File:Salix\\_exigua\\_var.\\_exigua\\_4.jpg](https://commons.wikimedia.org/wiki/File:Salix_exigua_var._exigua_4.jpg).

**Figure 263. *Baccharis salicifolia*.** Source: Krzysztof Ziarnek, Kenraiz, <https://commons.wikimedia.org/w/index.php?curid=54913701>.

**Figure 264. *Cyperus eragrostis*** Source: Krzysztof Ziarnek, Kenraiz, [https://commons.wikimedia.org/wiki/Category:Cyperus\\_eragrostis#/media/File:Cyperus\\_eragrostis\\_kz03.jpg](https://commons.wikimedia.org/wiki/Category:Cyperus_eragrostis#/media/File:Cyperus_eragrostis_kz03.jpg).

**Figure 265. *Typha latifolia*.** Source: R. A. Nonenmacher, [https://commons.wikimedia.org/wiki/File:Typha\\_latifolia\\_7642.jpg](https://commons.wikimedia.org/wiki/File:Typha_latifolia_7642.jpg).

**Figure 266. *Bolboschoenus maritimus*.** Source: Stefan Lefnaer, [https://commons.wikimedia.org/wiki/File:Bolboschoenus\\_maritimus\\_s.\\_str.\\_sl5.jpg](https://commons.wikimedia.org/wiki/File:Bolboschoenus_maritimus_s._str._sl5.jpg).

**Figure 267. *Schoenoplectus californicus*.** Source: Forest and Kim Starr, [https://upload.wikimedia.org/wikipedia/commons/2/2a/Burr\\_Marigold\\_Bidens\\_Laavis\\_%28237189541%29.jpeg](https://upload.wikimedia.org/wikipedia/commons/2/2a/Burr_Marigold_Bidens_Laavis_%28237189541%29.jpeg).

**Figure 268. *Bidens laevis*.** Source: Suzanne Antonia, [https://commons.wikimedia.org/wiki/File:Burr\\_Marigold\\_Bidens\\_Laavis\\_\(237189541\).jpeg](https://commons.wikimedia.org/wiki/File:Burr_Marigold_Bidens_Laavis_(237189541).jpeg).

**Figure 269. *Sparganium eurycarpum*.** Source: Tom Koerner, [https://commons.wikimedia.org/wiki/File:Bur-reed\\_\(Sparganium\\_eurycarpum\)\\_Sand\\_Lake\\_Wetland\\_Management\\_District\\_01\\_\(14385334072\).jpg#filelinks](https://commons.wikimedia.org/wiki/File:Bur-reed_(Sparganium_eurycarpum)_Sand_Lake_Wetland_Management_District_01_(14385334072).jpg#filelinks).

**Figure 270. *Artemisia douglasiana*.** Source: Römert, <https://commons.wikimedia.org/w/index.php?curid=19802958>.



*Salix exigua*



*Baccharis salicifolia*



*Cyperus eragrostis*



*Typha latifolia*



*Bolboschoenus maritimus*



*Schoenoplectus californicus*



*Bidens laevis*



*Sparganium eurycarpum*



*Artemisia douglasiana*



**SPECIES**

**SITING + PERFORMANCE**

BOTANICAL NAME	COMMON NAME	SITING + PERFORMANCE					
		FRAMES FOR BEST PERFORMANCE	CONSTRUCTED CONTEXTS	APPLICATIONS	SUN EXPOSURE	SETBACK FROM PAVEMENT (FEET)	
<b>TREES</b>							
<i>Alnus rhombifolia</i>	White alder	2-9	G	+ ^ ~ o	All	6	
<i>Populus fremontii</i> ssp. <i>fremontii</i>	Fremont cottonwood	1-9	F, G	+ ^ ~ o	FS	8	
<i>Populus trichocarpa</i>	Black cottonwood	1-9	F, G	+ ^ ~ o	FS	8	
<i>Salix gooddingii</i>	Black willow	1-9	F, G	+ ^ ~ o	FS	6	
<i>Salix laevigata</i>	Red willow	1-9	F, G	+ ^ ~ o	FS / PS	6	
<i>Sambucus nigra</i> ssp. <i>caerulea</i>	Mexican elderberry	1-9	C, E, F	+ ^ ~ o	FS	6	
<b>SHRUBS</b>							
<i>Baccharis salicifolia</i>	Mulefat	2-9	F, G	^ ~ o	All	3	
<i>Salix exigua</i>	Sandbar willow	2-9	F, G	^ ~ o	FS	6	
<i>Salix lasiandra</i>	Shining willow	1-9	F, G	+ ^ ~ o	FS / PS	5	
<i>Salix lasiolepis</i>	Arroyo willow	1-9	G	+ ^ ~ o	FS / PS	5	
<b>PERENNIALS</b>							
<i>Alisma triviale</i>	Water plantain	2-9	G	~ o	FS / PS	1	
<i>Artemisia douglasiana</i>	Mugwort	1-9	A, B, C, E, F	! ~ o	All	3	
<i>Bidens laevis</i>	Bur marigold	2-9	F, G	+ ~ o	FS	1	
<i>Equisetum hymale</i>	Scouring rush	1-9	F, G	~ o	PS	2	
<i>Sparganium eurycarpum</i>	Broadfruit bur-reed	2-9	G	~ o	FS / PS	3	
<i>Typha latifolia</i>	Broadleaf cattail	2-9	G	! ~ o	FS	1	
<b>GRASSES</b>							
<i>Bolboschoenus maritimus</i>	Alkali bulrush	2-9	G	~ o	FS	1	
<i>Carex fracta</i>	Fragile-sheathed sedge	5-9	F, G	~ o	FS / PS	2	
<i>Carex senta</i>	Swamp carex	5-9	F, G	~ o	PS	2	
<i>Carex spissa</i>	San Diego sedge	1-9	F, G	~ o	FS	2	
<i>Cyperus eragrostis</i>	Tall flatsedge	2-9	G	o	FS	1	
<i>Eleocharis macrostachya</i>	Common spikerush	1-9	F, G	~ o	FS	2	
<i>Elymus glaucus</i> ssp. <i>glaucus</i>	Blue wild rye	1-9	A, B, C, E, F, G	+	All	3	
<i>Juncus balticus</i>	Wire rush	2-9	G	~ o	PS	1	
<i>Juncus macrophyllus</i>	Long-leaved rush	5-9	F, G	~ o	PS	2	

## DESCRIPTIVE FEATURES

	PLANT FORM	WATER USE (WUCOLS IV)	MATURE HEIGHT (FEET)		MATURE WIDTH (FEET)		SHORTLIST PLANT	USACE NATIVE PLANT LIST	SEED LA TARGET LIST	OCCURRENCE IN COMMUNITY	OFTEN AVAILABLE IN CA	POLLINATOR HABITAT	BLOOM COLOR				BLOOM SEASON			
			W	SP	SU	F														
	T	H	20-30	20-30				Occasional	X	Birds, Butterflies	Green / Cream				X	X				
	T-D	M	30	35				Occasional	X	Birds, Butterflies	Cream	X	X							
	T-D	M	30	30+				Frequent - Occasional	X	Birds, Butterflies	Yellow	X	X							
	T-D	H	25	25				Frequent	X	Birds, Butterflies, Bees	Green	X	X							
	T-D	H	15-20	15-20				Frequent - Occasional	X	Birds, Butterflies, Bees	Yellow	X	X							
	T-D	L	15	20	X	X		Frequent - Occasional	X	Birds, Butterflies, Bees	Yellow/Cream		X	X						
	S	H	4-8	6-10	X	X		Occasional	X	Bees, Butterflies	White/Pink/White	X	X	X	X					
	S-D	H	10-25	10-12	X	X		Subdominant	X	Birds, Butterflies, Bees	Yellow	X	X							
	S/T-D	H	15	15				Dominant	X	Birds, Butterflies, Bees	Yellow		X							
	S/T-D	H	15	15	X			Frequent - Occasional	X	Birds, Butterflies, Bees	Cream	X	X							
	P	(Not Listed)	2-3	1.5-2				Occasional		Butterflies	White				X					
	P	M	3-5	3+	X	X		Frequent	X	Birds, Butterflies	Yellow / Cream		X	X	X					
	P	M	2-3	1-2				Occasional												
	P	H	3	3+				Frequent	X	Birds										
	P	(Not Listed)	4-6	2-3				Occasional		Butterflies	Green				X					
	P	(Not Listed)	4-6	4-6		X		Dominant												
	G/P/GC	(Not Listed)	3	2+				Dominant	X	Butterflies										
	G/P/GC	(Not Listed)	1.5-3	1.5-3				Occasional		Butterflies										
	G/P/GC	(Not Listed)	1.5-3	1.5-3				Occasional		Butterflies	Green		X							
	G/P/GC	M	2-4	2-4				Occasional	X	Butterflies	Brown/Green/Yellow		X							
	G/P/GC	H	2	30				Frequent	X		Green / Yellow		X	X	X					
	G/P/GC	H	1.5-3	2+				Frequent	X	Birds, Butterflies										
	G/P/GC	L	1.5-3	1+				Frequent - Occasional	X	Butterflies										
	G/P/GC	(Not Listed)	3	0.5-1		X		Frequent												
	G/P/GC	(Not Listed)	3	2+				Occasional												

**SPECIES**

**SITING + PERFORMANCE**

SPECIES		SITING + PERFORMANCE					
BOTANICAL NAME	COMMON NAME	FRAMES FOR BEST PERFORMANCE	CONSTRUCTED CONTEXTS	APPLICATIONS	SUN EXPOSURE	SETBACK FROM PAVEMENT (FEET)	
<b>GRASSES (continued)</b>							
<i>Juncus xiphioides</i>	Iris-leaf rush	2-9	G	~	PS	1	
<i>Schoenoplectus californicus</i>	California bulrush	2-9	G	! ~ o	FS	6	
<b>GROUNDCOVERS</b>							
<i>Anemopsis californica</i>	Yerba mansa	2-3, 5-9	F, G	* o	FS / PS	1	
<i>Carex praegracilis</i>	Slender sedge	1-9	D, E, F, G	o	FS / PS	1	
<i>Nasturtium officinale</i>	Watercress	2-9	G	~	FS	1	



## DESCRIPTIVE FEATURES

	PLANT FORM	WATER USE (WUCOLS IV)	MATURE HEIGHT (FEET)	MATURE WIDTH (FEET)	SHORTLIST PLANT	USACE NATIVE PLANT LIST	SEED LA TARGET LIST	OCCURRENCE IN COMMUNITY	OFTEN AVAILABLE IN CA	POLLINATOR HABITAT	BLOOM COLOR			
											W	SP	SU	F
	G/P/GC	(Not Listed)	1-3	1-2	X	Frequent	X	Butterflies						
	G/P/GC	(Not Listed)	6-12	3+		Dominant	X	Butterflies	Brown		X			
	P	M	0.5-1	1+		Frequent	X		White / Cream / Red	X	X			
	P/GC	M	.5-1	2+	X	Occasional	X							
	P	(Not Listed)	0.5-2	3+		Frequent			White / Green		X	X	X	

## DRY MEADOW

### Dry Meadow (DM):

The dry meadow is a community characterized by an open example of perennial bunchgrasses and annual and perennial wildflowers. Its extents have been greatly diminished in the LA River Watershed due to encroachment by agriculture, grazing, urbanization, and the invasion of non-native species. This community requires well-draining soils. This plant list includes examples of annual specials that would typically be found in dry meadows. Project-specific species lists and seed mixes can be developed with a qualified botanist or ecologist. Maintenance for yearly seed sowing and other measures specific to the dry meadow community must be planned before implementation. For example, weed management is crucial during the early development stages of this community.

- Requires well-drained soils.
- Seed sowing and additional maintenance specific to meadows is required.

**Figure 271.** *Elymus glaucus ssp. glaucus*. Source: Wild Bryde, <https://www.inaturalist.org/photos/38822555>.

**Figure 272.** *Lotus scoparius (Acmispon glaber)*. Source: glmory, <https://commons.wikimedia.org/w/index.php?curid=32092287>.

**Figure 273.** *Isocoma menziesii ssp. vernonioides*. Source: Miguel Vieira, <https://commons.wikimedia.org/w/index.php?curid=9389145>.

**Figure 274.** *Bromus carinatus*. Source: Matt Lavin, [https://www.flickr.com/photos/plant\\_diversity/3861052158](https://www.flickr.com/photos/plant_diversity/3861052158).

**Figure 275.** *Deinandra fasciculata*. Source: Björn S. [https://commons.wikimedia.org/wiki/File:Clustered\\_Tarweed\\_-\\_Deinandra\\_fasciculata\\_\(41948547430\).jpg](https://commons.wikimedia.org/wiki/File:Clustered_Tarweed_-_Deinandra_fasciculata_(41948547430).jpg).

**Figure 276.** *Stipa cernua*. Source: Kyle Nessen, <https://www.inaturalist.org/photos/38751036>.

**Figure 277.** *Stipa lepida*. Source: John Rusk, <https://commons.wikimedia.org/w/index.php?curid=59287600>.

**Figure 278.** *Muhlenbergia rigens*. Source: Krzysztof Ziarnek, Kenraiz, <https://commons.wikimedia.org/w/index.php?curid=54450777>.

**Figure 279.** *Koeleria macrantha*. Source: Matt Lavin, [https://commons.wikimedia.org/wiki/File:Koeleria\\_macrantha\\_\(3879657197\).jpg](https://commons.wikimedia.org/wiki/File:Koeleria_macrantha_(3879657197).jpg).



*Elymus glaucus* ssp. *glaucus*



*Lotus scoparius* (*Acmispon glaber*)



*Isocoma menziesii* ssp. *vernonioides*



*Bromus carinatus*



*Deinandra fasciculata*



*Stipa cernua*



*Stipa lepida*



*Muhlenbergia rigens*



*Koeleria macrantha*



**SPECIES**

**SITING + PERFORMANCE**

BOTANICAL NAME	COMMON NAME	SITING + PERFORMANCE				
		FRAMES FOR BEST PERFORMANCE	CONSTRUCTED CONTEXTS	APPLICATIONS	SUN EXPOSURE	SETBACK FROM PAVEMENT (FEET)
<b>SHRUBS</b>						
<i>Atriplex lentiformis</i> ssp. <i>lentiformis</i>	Saltbush	1-5	C, D, E	*!	FS	5
<i>Baccharis pilularis</i> var. <i>consanguinea</i>	Coyote brush	1-5	A, C, D	*!	FS / PS	4
<i>Isocoma menziesii</i> ssp. <i>vernonioides</i>	Goldenbush	1-9	A, C		FS / PS	2
<b>PERENNIALS</b>						
<i>Ambrosia psilostachya</i>	Western ragweed	1-9	A, B, C	+!	FS	1
<i>Bloomeria crocea</i>	Common goldenstar	1-9	A, B, C	+	FS / PS	0.5
<i>Epilobium canum</i> ssp. <i>canum</i>	Hoary California fuchsia	1-9	A, B	+	FS / PS	2
<i>Eschscholzia californica</i>	California poppy	1-9	C, D		FS / PS	1
<i>Grindelia camporum</i>	Great valley gumweed	1-9	A, B, C	+!	FS	2
<i>Lotus scoparius</i> ( <i>Acmispon glaber</i> )	Deerweed	1-6, 9	A, C	+*	FS	2
<i>Lupinus bicolor</i>	Miniature lupine	1-9	A, B, C	+!	FS	1
<i>Penstemon heterophyllus</i> var. <i>australis</i>	Foothill penstemon	1-3; 6-9	A, B, C		FS / PS	1
<i>Pseudognaphalium canescens</i>	Wright's cudweed	1-9	A, B, C	+	FS	0.5
<i>Sidalcea malviflora</i>	Checker bloom	5-9	A, B, C, D		FS / PS	1
<i>Sisyrinchium bellum</i>	Blue-eyed grass	1-9	E, F, G	o	FS / PS	1
<b>GRASSES</b>						
<i>Agrostis pallens</i>	Seashore bent grass	1-9	A, B, C, E, F, G	!	FS / PS	1
<i>Bromus carinatus</i> var. <i>carinatus</i>	California brome	1-9	A, B, C, E, F, G	*!	FS / PS	1
<i>Elymus glaucus</i> ssp. <i>glaucus</i>	Blue wild rye	1-9	A, B, C, E, F, G	+	All	3
<i>Elymus trachycaulus</i>	Slender wheatgrass	1-9	A, B, C, D		FS / PS	4
<i>Festuca californica</i>	California fescue	1-9	A, B, C, D, E	!	FS / PS	3
<i>Hordeum brachyantherum</i> ssp. <i>californicum</i>	California meadow barley	1-9	A, B, C, E, F, G		FS / PS	2
<i>Koeleria macrantha</i>	Junegrass	1-9	A, B, C, D	+*	FS / PS	1
<i>Melica californica</i>	California melicgrass	5-9	A, B, C, D		FS / PS	1
<i>Muhlenbergia rigens</i>	Deergrass	1-9	A, B, C, E, F		FS / PS	3
<i>Sporobolus airoides</i>	Alkali sacaton	1-5	A, C, D	*	FS	2
<i>Stipa cernua</i>	Nodding needlegrass	1-9	A, B, C, E		FS / PS	1

## DESCRIPTIVE FEATURES

	PLANT FORM	WATER USE (WUCOLS IV)	MATURE HEIGHT (FEET)	MATURE WIDTH (FEET)	OCCURRENCE IN COMMUNITY	OFTEN AVAILABLE IN CA	POLLINATOR HABITAT	BLOOM COLOR				BLOOM SEASON			
								W	SP	SU	F	W	SP	SU	F
	S	VL	6-8	5-10	Occasional	X	Birds, Butterflies	Yellow/Brown			X				
	S	L	4-6	6-8	Occasional	X	Bees, Butterflies	Yellow/Cream	X	X	X	X			
	S	VL	1-3	3	Occasional	X	Bees, Butterflies	Yellow		X	X	X			
	P	(Not Listed)	3-7	1	Occasional	X	Butterflies, Bees	Green			X	X			
	P	VL	1	0.5	Occasional	X		Yellow		X					
	P	VL	1-3	2-4	Occasional		Birds, Butterflies	Red			X	X			
	A/P-D	VL	1	1-2	Occasional	X	Birds, Butterflies, Bees	Orange / Yellow		X					
	P	VL	2-6	3	Frequent - Occasional	X	Butterflies	Yellow		X	X	X			
	P	VL	3	3	Frequent - Occasional	X	Bees, Butterflies	Yellow	X	X	X				
	P	(Not Listed)	0.25-1	1	Frequent - Occasional	X	Birds, Butterflies, Bees	Blue/Lavender/White		X					
	P	L	1	1	Occasional	X	Birds, Butterflies, Bees	Purple/Blue		X	X				
	P	(Not Listed)	3	0.5	Occasional		Butterflies, Bees	Cream/Yellow/Brown			X	X			
	P	L	0.3-1.5	0.5	Occasional	X	Birds, Butterflies	Pink		X	X				
	P-D	L	1	1	Frequent - Occasional	X	Butterflies	Purple		X					
	G/P/GC	(Not Listed)	0.33-2.3	2	Frequent	X	Butterflies	Green		X					
	G/P/GC	(Not Listed)	1.5-3	1+	Frequent	X	Butterflies	Yellow		X					
	G/P/GC	L	1.5-3	1+	Occasional	X	Butterflies								
	G/P/GC	(Not Listed)	3-5	3+	Occasional	X	Butterflies	Yellow		X					
	G/P/GC	L	1.3-4	3	Frequent	X	Butterflies	Yellow	X	X					
	G/P/GC	L	1.5-4	1+	Frequent	X	Butterflies	Yellow		X					
	G/P/GC	L	1-2	1	Frequent	X	Butterflies								
	G/P/GC	L	1-4.3	1	Frequent	X	Butterflies	Yellow/Purple			X				
	G/P/GC	L	1-2	4	Occasional	X	Birds								
	G/P	L	3-4	2	Occasional	X	Butterflies								
	G/P/GC	VL	2	2	Occasional	X									

DRY MEADOW

SPECIES

SITING + PERFORMANCE

SPECIES		SITING + PERFORMANCE				
BOTANICAL NAME	COMMON NAME	FRAMES FOR BEST PERFORMANCE	CONSTRUCTED CONTEXTS	APPLICATIONS	SUN EXPOSURE	SETBACK FROM PAVEMENT (FEET)
<b>GRASSES (continued)</b>						
<i>Stipa coronatum</i>	Giant stipa	1-9	A, E, F		FS / PS	2
<i>Stipa lepida</i>	Foothill needlegrass	1-9	A, B, C, D		FS / PS	1
<i>Stipa pulchra</i>	Purple needlegrass	1-9	A, B, C, E	*!	FS / PS	1
<b>GROUNDCOVERS</b>						
<i>Achillea millefolium var. californicum</i>	Yarrow	1-9	A, B, C, D, E, F	!	FS / PS	1
<i>Salvia spathacea</i>	Hummingbird sage	1-9	B, C, E		PS / FS	2
<b>ANNUALS</b>						
<i>Achyrachaena mollis</i>	Blow wifes	1-9	A, B, C	~ o	FS	0.5
<i>Ambrosia acanthicarpa</i>	Annual bursage	1-9	A, B, C	o	FS / PS	1
<i>Apiastrum angustifolium</i>	Mock parsley	1-9	A, B, C	~ o	FS	0.5
<i>Camissoniopsis bistorta</i>	California sun cup	1-9	A, B, C	~	FS	0.5
<i>Chaenactis glabriuscula</i>	Yellow pincushion	1-9	A, B, C	! ~ o	FS	1
<i>Cryptantha intermedia</i>	Common cryptantha	1-9	A, B, C	* o	FS	0.5
<i>Deinandra fasciculata</i>	Clustered tarweed	1-9	A, B, C	~	FS	1.5
<i>Lasthenia californica</i>	California goldfields	1-9	A, B, C		FS / PS	0.5
<i>Layia platyglossa</i>	Coastal tidy tips	1-9	A, B, C		FS	2
<i>Lepidium nitidum</i>	Peppergrass	1-9	A, B, C		FS	0.5
<i>Phacelia stellaris</i>	Brand's star phacelia	1-6	A, B, C		FS	0.5



## DESCRIPTIVE FEATURES

PLANT FORM	WATER USE (WUCOLS IV)	MATURE HEIGHT (FEET)	MATURE WIDTH (FEET)	OCCURRENCE IN COMMUNITY	OFTEN AVAILABLE IN CA	POLLINATOR HABITAT	BLOOM COLOR	BLOOM SEASON			
								W	SP	SU	F
G/P/GC	(Not Listed)	2-4	1-2	Occasional	X						
G/P/GC	VL	1-1	2	Occasional	X						
G/P/GC	VL	1-1	2	Occasional	X	Butterflies	Cream		X		
P/GC	L	0.5-2	3	Occasional	X	Birds, Butterflies, Bees	White		X	X	
P/GC	L	1	3+	Occasional	X	Birds, Butterflies, Bees	Red/Pink	X	X	X	
A	(Not Listed)	1-1.5	0.5	Occasional	X		White		X		
A	(Not Listed)	3-5	1	Occasional	X	Butterflies, Bees	Cream			X	X
A	(Not Listed)	1.5	0.25	Occasional			White		X		
A	(Not Listed)	1-2	1-2	Occasional	X	Butterflies	Yellow		X		
A	(Not Listed)	1.5	0.5	Occasional		Bees	Yellow	X	X	X	
A	(Not Listed)	0.25-1.5	0.25	Occasional		Butterflies, Bees	White/Yellow		X		
A	(Not Listed)	3	2	Frequent	X	Butterflies, Bees	Yellow		X	X	X
A	(Not Listed)	0.5-1.5	0.5	Occasional	X	Butterflies, Bees	Yellow	X	X		
A	(Not Listed)	0.5-2	0.5-2	Frequent	X	Butterflies	Yellow	X	X		
A	(Not Listed)	1	0.5	Occasional		Butterflies	White		X		
A	(Not Listed)	0.25-1	0.25	Occasional		Butterflies, Bees	Lavender		X		

## DESERT SCRUB

### Desert Creosote Bush Scrub (DS):

The Desert Creosote Bush Scrub is not a community currently native to the LA River watershed, but is native to the low-lying deserts in southeastern California (below 3500 feet) and are plant species that are part of Los Angeles' Level III ecoregion or in a Level III ecoregion directly adjacent. With increased temperatures and more frequent weather extremes, including drought, the plants from this list may perform well in the urban conditions of the LA River corridor. However, this list is not intended to replace the use of California natives currently adapted to Los Angeles but to list examples of species that will tolerate increasing temperatures.

- Requires well-drained soils, can tolerate alkaline soils and salt.
- Tolerant of a wide range of temperatures, including intense heat.

**Figure 280. *Parkinsonia florida*.** Source: Stan Shebs, <https://commons.wikimedia.org/w/index.php?curid=344153>.

**Figure 281. *Quercus wislizeni*.** Source: Krzysztof Ziarnik, Kenraiz, [https://commons.wikimedia.org/wiki/File:Quercus\\_wislizeni\\_kz3.jpg](https://commons.wikimedia.org/wiki/File:Quercus_wislizeni_kz3.jpg).

**Figure 282. *Atriplex canescens*.** Source: Stan Shebs, <https://commons.wikimedia.org/w/index.php?curid=4269398>.

**Figure 283. *Calliandra eriophylla*.** Source: Chris English, <https://commons.wikimedia.org/w/index.php?curid=56261079>.

**Figure 284. *Fallugia paradoxa*.** Source: Stan Shebs, <https://commons.wikimedia.org/w/index.php?curid=3929255>.

**Figure 285. *Larrea tridentata*.** Source: Andrey Zharkikh, <https://commons.wikimedia.org/w/index.php?curid=60781561>.

**Figure 286. *Encelia farinosa*.** Source: Stan Shebs, <https://commons.wikimedia.org/w/index.php?curid=204952>.

**Figure 287. *Sphaeralcea ambigua*.** Source: Stan Shebs, <https://commons.wikimedia.org/w/index.php?curid=8563714>.

**Figure 288. *Abutilon palmeri*.** Source: Ken-ichi Ueda, <https://www.inaturalist.org/photos/27181425?size=large>.



*Parkinsonia florida*



*Quercus wislizeni*



*Atriplex canescens*



*Calliandra eriophylla*



*Fallugia paradoxa*



*Larrea tridentata*



*Encelia farinosa*



*Sphaeralcea ambigua*



*Abutilon palmeri*



**SPECIES**

**SITING + PERFORMANCE**

BOTANICAL NAME		COMMON NAME	FRAMES FOR BEST PERFORMANCE	CONSTRUCTED CONTEXTS	APPLICATIONS	SUN EXPOSURE	SETBACK FROM PAVEMENT (FEET)
<b>TREES</b>							
<i>Celtis laevigata</i> var. <i>reticulata</i>		Western hackberry	1-9	C, D, E	^ *	FS / PS	6
<i>Chilopsis linearis</i>		Desert willow	3-9	C, D, E	+ ^ *	FS	6
<i>Parkinsonia florida</i>		Blue palo verde	3-9	C, D, E	^ *	FS	6
<i>Quercus wislizeni</i>		Interior live oak	3-9	C, D, E	^ *	FS	10
<b>SHRUBS</b>							
<i>Atriplex canescens</i>		Four-wing saltbush	1-9	C, D, E	+ *	FS	4
<i>Baccharis sarothroides</i>		Broom baccharis	1-9	A, C, D, E	* !	FS	4
<i>Calliandra eriophylla</i>		Fairy duster	3-9	C, D, E, F	+ *	FS	2
<i>Encelia actoni</i>		Acton brittlebush	1-9	A, C, D	*	FS	3
<i>Encelia farinosa</i>		Brittlebush	3-9	A, C, D, E	+ * !	FS	2
<i>Ephedra viridis</i>		Mountain ephedra	3-9	A, C, D, E	*	FS / PS	3
<i>Ericameria nauseosa</i>		Rabbitbrush	3-9	A, C, D, E	+ *	FS	4
<i>Eriogonum fasciculatum</i> var. <i>foliolosum</i>		Leafy California buckwheat	1-9	A, C	+ !	FS / PS	3
<i>Eriogonum fasciculatum</i> var. <i>polifolium</i>		Interior California buckwheat	3-9	A, C	+ * !	FS / PS	3
<i>Fallugia paradoxa</i>		Apache plume	3-9	A, C, D	* !	FS / PS	3
<i>Frangula californica</i> ssp. <i>californica</i>		California coffeeberry	1-9	A, B, C, D	* !	All	6
<i>Hyptis emoryi</i>		Desert lavender	3-9	C, D, E	*	FS	6
<i>Isomeris arborea</i>		Bladder pod	1-9	A, C, D, E	+ * !	FS	3
<i>Justicia californica</i>		Chuparosa	3-9	C, D, E	* !	FS	2
<i>Larrea tridentata</i>		Creosote bush	3-9	C, D, E	*	FS	4
<i>Lupinus excubitus</i>		Grape soda lupine	1-9	C, D, E	+ *	FS	4
<i>Lycium andersonii</i>		Water jacket	1-9	A, C, D, E	*	FS	4
<i>Peritoma arborea</i>		Bladderpod	1-9	A, B, C	+ !	FS / PS	4
<i>Prosopis glandulosa</i>		Honey mesquite	3-9	C, D, E, F	+ ^ *	FS	6
<i>Salvia apiana</i>		White sage	3-9	A, C, D	+ !	FS	3
<i>Scutellaria mexicana</i>		Mexican bladdersage	3-9	C, D, E	*	FS / PS	1

## DESCRIPTIVE FEATURES

	PLANT FORM	WATER USE (WUCOLS IV)	MATURE HEIGHT (FEET)	MATURE WIDTH (FEET)	OCCURRENCE IN COMMUNITY	OFTEN AVAILABLE IN CA LA LEVEL III Ecoregion			POLLINATOR HABITAT	BLOOM COLOR				BLOOM SEASON				
						ADJACENT LEVEL III ECOREGION				W	SP	SU	F					
	T-D	L	20-40	20-40	Occasional	X		X		Cream		X						
	T-D	VL	25	25	Occasional	X		X	Birds, Butterflies, Bees	White + Pink		X	X					
	T	VL	25	20	Occasional	X		X	Birds, Bees	Yellow		X						
	T-D/S	VL	15-50	10-50	Occasional	X	X		Birds, Butterflies	Cream/Green	X	X						
	S	VL	1-10	3-7	Frequent - Occasional	X	X	X	Birds, Butterflies	Yellow/Green		X	X					
	S	VL	1-12	6	Occasional	X	X	X	Birds, Butterflies, Bees	Cream				X				
	S	VL	1-3	3	Occasional	X		X	Birds, Butterflies, Bees	Pink/Purple	X	X						
	S	VL	5	5	Frequent - Occasional	X	X	X	Bees	Yellow		X	X	X				
	S	VL	1-5	4	Occasional	X	X	X	Bees	Yellow	X	X						
	S	VL	3-5	3-5	Frequent - Occasional	X	X			Yellow		X						
	S	(Not Listed)	3-9	3-9	Occasional	X		X	Bees, Butterflies	Yellow				X	X			
	S	VL	3-5	2-6	Occasional	X	X	X	Birds, Butterflies, Bees	Red/Cream				X				
	S	VL	3-5	2-6	Occasional	X	X	X	Birds, Butterflies, Bees	Pink/Cream				X				
	S	VL	3-6	6	Frequent - Occasional	X		X		Lavender/Pink/ White/Green		X						
	S	VL	8	12	Occasional	X	X		Birds, Butterflies, Bees	Cream		X	X					
	S	VL	6-12	8	Occasional	X		X		Lavender/Blue	X	X						
	S	VL	1-6	6	Occasional	X	X	X	Birds, Butterflies, Bees	Yellow	X	X						
	S	VL	2-4	4	Occasional			X	Birds, Butterflies, Bees	Red/Yellow		X						
	S	VL	3-12	6-12	Dominant	X		X	Bees	Yellow		X						
	S	L	7	7	Occasional	X	X	X	Birds, Butterflies, Bees	Purple/White		X	X					
	S	VL	6	6	Occasional	X		X	Birds	Cream		X						
	S	VL	3-5	5	Occasional	X	X	X	Birds, Butterflies, Bees	Yellow/Green	X	X						
	T-D/S	L	20-30	30	Occasional	X		X	Butterflies	Yellow		X	X					
	S	VL	3	3-5	Occasional	X	X		Birds, Butterflies, Bees	White	X	X	X					
	S	(Not Listed)	1-3	1-3	Occasional			X	Bees	Purple		X	X					



**SPECIES**

**SITING + PERFORMANCE**

BOTANICAL NAME	COMMON NAME	SITING + PERFORMANCE					
		FRAMES FOR BEST PERFORMANCE	CONSTRUCTED CONTEXTS	APPLICATIONS	SUN EXPOSURE	SETBACK FROM PAVEMENT (FEET)	
<b>SHRUBS (continued)</b>							
<i>Simmondsia chinensis</i>	Jojoba	1-9	A, C, D, E	+*!	FS	4	
<i>Sphaeralcea ambigua</i>	Apricot mallow	1-9	A, C, D, E	*	FS	1	
<i>Tecoma stans</i>	Yellow bells	1-9	A, C, D, E	*!	FS	6	
<b>PERENNIALS</b>							
<i>Abutilon palmeri</i>	Palmer's Indian mallow	1-9	A, C, D	*	FS	2	
<i>Asclepias erosa</i>	Desert milkweed	3-9	A, C, D	+*	FS	1	
<i>Romneya coulteri</i>	Coulter's Matilija poppy	1-9	A, C, D, E	*	FS	3	
<b>GRASSES</b>							
<i>Aristida purpurea</i>	Purple three awn	1-9	A, C, D, E	*	FS	1	
<i>Bouteloua gracilis</i>	Blue grama	3-9	A, C, D, E	*	FS / PS	1	
<i>Sporobolus airoides</i>	Alkali sacaton	1-5	A, C, D	*	FS	2	
<i>Stipa hymenoides</i>	Indian ricegrass	3-9	A, C, D	*	FS	1	
<i>Stipa speciosa</i>	Desert needlegrass	3-9	A, C, D, E	*	FS	1	
<b>SUCCULENTS</b>							
<i>Agave deserti</i>	Desert agave	3-9	A, C, D	*	FS	3	
<i>Fouquieria splendens</i>	Ocotillo	3-9	A, C, D, E	*	FS	3	
<i>Opuntia basilaris</i>	Beaver tail	3-5, 9	A, C	*	FS	2	
<i>Yucca schidigera</i>	Mojave yucca	1-9	A, C, D	*	FS	3	
<b>VINES</b>							
<i>Vitis girdiana</i>	Desert grape	3-9	G	o	All	2	

## DESCRIPTIVE FEATURES

	PLANT FORM	WATER USE (WUCOLS IV)	MATURE HEIGHT (FEET)	MATURE WIDTH (FEET)	OCCURRENCE IN COMMUNITY	OFTEN AVAILABLE IN CA LA LEVEL III ECOREGION			POLLINATOR HABITAT	BLOOM COLOR				
										W	SP	SU	F	
	S	VL	3-7	4-7	Occasional	X		X	Birds	Cream		X		
	S	L	3-5	2-4	Frequent - Occasional	X	X	X	Bees, Butterflies	Red/Orange	X	X		
	S	L	15-20	15-20	Occasional	X			Birds, Bees	Yellow			X	X
	P	L	3-8	3-5	Occasional	X	X	X	Butterflies	Yellow/Orange		X		
	P	VL	3	1	Occasional		X	X	Birds, Butterflies	Cream		X	X	X
	P	VL	6-8	6-8	Frequent	X	X		Bees, Butterflies	White/Yellow		X	X	
	G/P/GC	VL	1-3	2	Frequent - Occasional	X	X	X						
	G/P/GC	L	.5-2	2	Occasional	X	X	X	Butterflies	Yellow/Tan			X	
	G/P	L	3-4	2	Occasional	X	X	X	Butterflies					
	G/P	VL	1.2-2.3	1.5	Occasional	X	X	X	Butterflies	Yellow		X		
	G/P/GC	(Not Listed)	1-2	1	Frequent		X	X						
	SC	(Not Listed)	1-20	3	Occasional	X		X	Butterflies	Yellow		X	X	
	S/SC	VL	10-20	15	Occasional	X		X	Birds	Red		X	X	
	SC	VL	1-2	2	Occasional		X	X		Pink		X		
	SC	VL	1-16	5	Occasional	X	X	X	Birds, Butterflies	Cream		X		
	V/S-D	L	climbs		Occasional	X	X	X	Birds	Green		X		

## CLIMATE-ADAPTED TREES

### Climate Adapted Trees (CT):

The following list provides options for both California native and non-native, non-invasive tree species when more species diversity is desired. However, planting the native trees from the prior lists in this chapter is encouraged wherever possible. These trees have also been selected for their ability to survive in often harsh urban conditions and are tolerant of both smog and heat. If a project is an urban-wildland interface area, the use of non-native species is not encouraged.

- Useful at gateways for visual impact or additional shade.
- Can tolerate the harsh urban environment.
- Additional species can be considered on a per-project basis.

**Figure 289. *Cercis occidentalis*.** Source: Stan Shebs, [https://commons.wikimedia.org/wiki/File:Cercis\\_occidentalis\\_1.jpg](https://commons.wikimedia.org/wiki/File:Cercis_occidentalis_1.jpg).

**Figure 290. *Chilopsis linearis*.** Source: Krzysztof Ziarnik, Kenraiz, <https://commons.wikimedia.org/w/index.php?curid=54448559>.

**Figure 291. *Chitalpa tashkentensis*.** Source: Frau Siebenschläfer, <https://commons.wikimedia.org/w/index.php?curid=15746538>.

**Figure 292. *Hesperocyparis forbesii*.** Source: Consultaplantas, [https://commons.wikimedia.org/wiki/File:Cupressus\\_forbesii\\_1c.JPG](https://commons.wikimedia.org/wiki/File:Cupressus_forbesii_1c.JPG).

**Figure 293. *Lyonothamnus floribundus* ssp. *asplenifolius*.** Source: J Brew, <https://commons.wikimedia.org/w/index.php?curid=15394974>.

**Figure 294. *Pinus torreyana*.** Source: Richard O. Barry, [https://en.m.wikipedia.org/wiki/File:Pinus\\_torreyana\\_at\\_State\\_Reserve.jpg](https://en.m.wikipedia.org/wiki/File:Pinus_torreyana_at_State_Reserve.jpg).

**Figure 295. *Quillaja saponaria*.** Source: Daderot, <https://commons.wikimedia.org/w/index.php?curid=37387713>.

**Figure 296. *Quercus douglasii*.** Source: Yath, [https://commons.wikimedia.org/wiki/File:Large\\_Blue\\_Oak.jpg](https://commons.wikimedia.org/wiki/File:Large_Blue_Oak.jpg).

**Figure 297. *Tipuana tipu*.** Source: Daniel Ventura, <https://commons.wikimedia.org/w/index.php?curid=2246165>.





*Cercis occidentalis*



*Chilopsis linearis*



*Chitalpa tashkentensis*



*Hesperocyparis forbesii*



*Lyonothamnus floribundus ssp. asplenifolius*



*Pinus torreyana*



*Quillaja saponaria*



*Quercus douglasii*



*Tipuana tipu*

**SPECIES**

**SITING + PERFORMANCE**

BOTANICAL NAME	COMMON NAME	SITING + PERFORMANCE				
		FRAMES FOR BEST PERFORMANCE	CONSTRUCTED CONTEXTS	APPLICATIONS	SUN EXPOSURE	SETBACK FROM PAVEMENT (FEET)
<b>TREES</b>						
<i>Arbutus 'Marina'</i>	Marina madrone	1-9	C, D, E	+ *	FS	15
<i>Calocedrus decurrens</i>	Incense cedar	3-9	A, B, C, D	+	FS / PS	15
<i>Cercis occidentalis</i>	Western redbud	3-9	B, C, E	+ ^	FS / PS	5
<i>Chilopsis linearis</i>	Desert willow	3-9	C, D, E	+ ^ *	FS	4-6
<i>Chitalpa tashkentensis</i>	Chitalpa	1-9	C, D, E	^ *	FS / PS	6-8
<i>Cordia boissieri</i>	Texas wild olive	1-9	A, C, D, E	^ *	FS	6-8
<i>Cupressus arizonica</i>	Arizona cypress	3-9	A, C, D	*	FS / PS	10
<i>Dalbergia sissoo</i>	Indian rosewood	3-9	A, C, D, E	* !	FS / PS	10
<i>Forestiera neomexicana</i>	Desert olive	1-9	A, B, C, D, E	+ ^ *	FS	6-8
<i>Hesperocyparis forbesii</i>	Tecate cypress	3-9	C, D	+ * !	FS	10
<i>Laurus nobilis</i>	Sweet bay	1-9	A, C, D, E	^ *	FS / PS	6-8
<i>Lophostemon confertus</i>	Brisbane box	1-5	C, E, F	^	FS / PS	6-8
<i>Lyonothamnus floribundus ssp. asplenifolius</i>	Ironwood	1-5	B, C, E	^	FS / PS	6-8
<i>Olneya tesota</i>	Desert ironwood	3-9	C, D, E	+ *	FS	6-8
<i>Pinus canariensis</i>	Canary Island pine	1-9	A, B, C, D	*	FS / PS	5
<i>Pinus coulteri</i>	Coulter pine	3-9	A, B, C	+	FS / PS	6-8
<i>Pinus eldarica</i>	Eldarica pine	1-9	C, D, E	^ *	FS	6-8
<i>Pinus halepensis</i>	Aleppo pine	1-9	A, B, C, D, E	*	FS	6-8
<i>Pinus muricata</i>	Bishop pine	1-9	A, B, C, D, E	*	FS / PS	10
<i>Pinus pinea</i>	Stone pine	1-9	A, B, C, D, E	^ *	FS	15
<i>Pinus torreyana</i>	Torrey pine	1-9	A, B, C	+	FS / PS	10
<i>Quercus chrysolepis</i>	Canyon live oak	1-9	A, B, C, D, E	+ ^	FS / PS	15
<i>Quercus douglasii</i>	Blue oak	3-9	A, B, C, D, E	+ ^	FS / PS	10
<i>Quercus engelmannii</i>	Engelmann oak	3-9	A, B, C, D	+ ^ * !	FS	15
<i>Quillaja saponaria</i>	Soapbark tree	1-9	C, D, E	^ *	FS / PS	10
<i>Searsia lancea</i>	African sumac	1-9	C, D, E	^ * !	FS	10
<i>Tipuana tipu</i>	Tipu tree	1-9	C, D, E	^ *	FS / PS	15
<i>Vitex agnus-castus</i>	Chaste tree	1-9	A, B, C, D, E	^ *	FS	5



## DESCRIPTIVE FEATURES

	PLANT FORM	WATER USE (WUCOLS IV)	MATURE HEIGHT (FEET)		MATURE WIDTH (FEET)		ADJACENT LEVEL III ECOREGION	BLOOM COLOR	BLOOM SEASON			
									W	SP	SU	F
T	M	25-40	50				Pink			X		
T	M	12-150	50	X	X							
T-D	L	6-25	10-18	X			Pink		X			
T-D	VL	25	25	X	X		White + Pink		X	X		
T-D	L	20-35	20-30				Pink		X	X	X	
T	L	15-25	15-25									
T	VL	30-80	30	X	X							
T-D	L	45-60	30-40				Yellow/Cream		X	X		
T/S	L	10-18	10	X	X							
T	VL	33	25	X								
T/S	L	40	30				Yellow		X			
T	M	30-60	20-40				White			X		
T	L	30-60	20-40	X			White/Brown		X	X		
T	(Not Listed)	20-30	20		X		Purple		X			
T	L	50-80	20-35									
T	L	30-60	25-40	X								
T	L	30-55	11-24									
T	L	30-60	20-40									
T	L	40-90	30	X								
T	L	40-50	40-50									
T	L	40-70	20-45	X								
T	L	30-90	30-60	X			Yellow/Cream	X	X			
T-D	VL	15-80	30	X			Yellow/Cream	X	X			
T-D	VL	30-60	60-90	X			Yellow/Cream	X	X			
T	L	25-60	10-35				Yellow/Cream		X	X		
T	L	20-25	20-35				Yellow/Green			X		
T-D	L	50	50+				Yellow			X		
T/S-D	L	8-10	5-8				Purple			X		

# ECOLOGY, HABITAT, AND PLANTING CHECKLIST

Reference the LACFCD and Public Works Permitting checklist in Chapter 2 for an overview of project permitting and applicable codes.

## Detailed Drawing and Specification Technical Requirements Checklist for Ecology, Habitat, and Planting

### Planting Along Levees and Floodwalls

- Follow the most recent USACE Guidelines.
- Follow the 17-foot Limited Landscape Management Zone requirements.
- Indicate in site plan a 3 - 6-foot clear line of sight at access points and trail intersections.
- Deploy BMPs to capture stormwater where possible.

### Maintenance Buffers and Clearances

- All maintenance vehicles must have ingress and egress clearance at all times.
- Any alteration or design of service roads must meet with county approval.
- A minimum 4-foot setback from sidewalk for trees and tall shrubs where adjacent to vehicular ingress/egress from arterial streets.
- Vehicular access gates are to be setback 20 feet from the arterial street curb when available and feasible.
- Consult with appropriate utility company if working in a utility easement or right-of-way.

### Soils

- Test soils. If soils are contaminated, create a remediation plan.
- Peat shall not be specified as a soil mix component.
- Test samples of salvaged on-site topsoil, all plant mix materials, and organic material components which are intended to be used for planting soil mixes and final mixes by an independent Soil and Plant Testing Laboratory acceptable to the landscape architect and in accordance with the current standards of the Soil Science Society of America. All reports shall be sent to the landscape architect for approval.

### **Irrigation**

- Irrigation supply and system components shall comply with LA County Low Impact Development Manual, LA County water sources, conservation standards, and current California Green Building Standards Code.
- Use recycled or reclaimed water for irrigation where possible; ensure planting is compatible with salinity levels of irrigation water.
- Provide a soil and water source analysis prior to design of the irrigation system and develop a watering, nutrition, and amendment schedule in response to the analysis.
- Analyze total dissolved salts from water sources to confirm plant types are compatible with saline soils. Provide soil amendments or ongoing organic water treatment to reduce high salt or TDS (total dissolved solid) levels.
- All drip irrigation systems shall be installed in a manner that can provide multiple emitters to each container plant.
- Irrigation details shall provide for appropriate use of in-line filters, pressure regulators, pressure compensating emission devices, and end-flush valves.

### **Wildfire management**

- For larger projects or those that interface with a wildlife area, indicate wildfire breaks on the site plan.

# ECOLOGY, HABITAT, AND PLANTING CHECKLIST

Reference the LACFCD and Public Works Permitting checklist in Chapter 2 for an overview of project permitting and applicable codes.

## Tree and Shrub Planting

- Do not plant species listed as invasive by the California Invasive Plant Council (Cal-IPC).
- Planting in the LA River channel should only occur where excess hydraulic capacity is confirmed.
- Planting plans should show frequency and placement of plant species with graphic hatches and annotations. Hatches can be further detailed with a graphic matrix showing typical plant placement. Sizes and quantity should be indicated on the corresponding plant schedule.
- Identify areas on plan that are habitat focused and those that are program focused.
- In habitat-focused areas, show that the following criteria is met in the planting schedule:
  - 95% minimum of the total number of plants of the same pot size to be LA River Watershed native species (refer to the native plant community lists in this chapter).
  - 5% maximum of the total number of plants of the same pot size to be native to Los Angeles' Level III ecoregion (Southern California/Northern Baja Coast; Southern California Mountains).
  - 10% minimum of the total number of LA River Watershed native plants of the same pot size to be locally sourced in the LA River Watershed. Higher percentages should be achieved as local supply capacity increases.
- In program-focused areas, show that the following criteria is met in the planting schedule:
  - 85% minimum of the total number of plants of the same pot size to be native to the LA River Watershed (refer to the native plant community lists in this chapter) or the Level III ecoregions of Los Angeles and just east of Los Angeles, as appropriate per planting context and climate regimes (Southern California/Northern Baja Coast; Southern California Mountains; Mojave Basin and Range; Sonoran Basin and Range).
  - 15% maximum of the total number of plants of the same pot size to be climate-adapted, non-native non-invasive species.

- Install native planting in the late fall through winter (between November 1 and March 15 or as specified in the schedule prepared by the project landscape architect).
- Eradicate all existing invasive non-native plant species on-site. Existing, non-native, non-invasive species may be retained until senescence then replaced with appropriate native plants.
- Procure plant material from a nursery that holds an appropriate nursery license with the California Department of Food and Agriculture (CDFA) to sell the requested plant material. Contractor shall submit proof of license that all plant material was obtained by a pest free nursery in good standing with CDFA.
- Plant material quantities and handling standards must comply with the latest version of the American Standard for Nursery Stock (ANSI Z60.1) published by the American Horticulture Industry Association.
- Procure plants that are not rootbound.
- Avoid purchasing plants affected by pathogens and use nurseries that incorporate best practices for pathogen avoidance, such as member nurseries of the Southern California Nursery Best Management Practices (BMP) Group.
- The contractor shall acquire all seed material of the required type, sizes, and quantities through sources approved by the project landscape architect. Weed seed shall not exceed 1% by weight of the total mixture. Wet, moldy, or otherwise damaged seed shall be rejected.
- Do not use seeds treated with mercury.
- Include proper drainage of planting in drawings and installation.
- Conduct percolation tests to determine positive drainage of all plant pits. Note percolation performance requirements may be designated by the landscape architect or as required in the LA County Public Works Low Impact Development Manual.
- All plants are to be thoroughly watered upon installation to compact soil and settle plants to natural soil depth. Excessive watering shall be minimized to prevent erosion.
- Planting areas that are not seeded are to be covered with 3-6 inches of organic mulch.



# ECOLOGY, HABITAT, AND PLANTING CHECKLIST

Reference the LACFCD and Public Works Permitting checklist in Chapter 2 for an overview of project permitting and applicable codes.

## Detailed Maintenance Program Checklist for Ecology, Habitat, and Planting

All projects along the LA River are required to develop a three year monitoring and maintenance program prior to start of construction. This program begins on completion of the last day of the planting operation and emphasizes proper application of supplemental water, replacement planting, and weed management to achieve an increased rate of vegetation establishment and growth. Regular inspections and decisions regarding weed management, supplemental irrigation, and additional planting actions should also be in the plan.

### 3 Year Monitoring and Maintenance Program

#### Program Management

- All management actions shall be implemented by experienced crews with knowledge and familiarity of native plants and adaptive management. Education, training, and/or certification in the care of CA native species and habitat planting is required for these maintenance crews.
- All maintenance actions are to be managed by the landscape architect, botanist, ecologist, or land care professional who is responsible to conduct regular inspections, maintain written records, and to make decisions that will further improve the establishment of the vegetation. Twice monthly visits are to be scheduled in the first 16 weeks of planting establishment to observe landscape performance. A brief summary report shall be prepared for each visit by approved professionals (the landscape architect, botanist, ecologist, or land care professional).
- All programs, schedules of maintenance action, and summary reports shall be submitted to the county/contracting officer.

#### Tree and Shrub Planting

- Include budget for replacement planting. Long-term management actions and replacement plantings are to emphasize native species and non-invasive species for future climate regimes.
- Restoration of damage to landscape plantings by acts of vandalism, storms, heavy equipment, or other causes shall be repaired or replaced in a manner that is consistent with the original planting program unless otherwise directed by the landscape architect. (Adjustments to the types of replacement plants may be decided if a particular species is showing inadequate suitability to the conditions of the site.)
- Plants shall be checked for settlement and shall be reset at proper grade as necessary.
- Germination and growth of plants is to be inspected on a weekly basis for the first three months following planting to monitor progress and observe problems as they arise.
- Monitoring should include noting any signs of insect or disease outbreaks, with treatment taken as needed.

- If staking trees is specified they shall be inspected monthly and be maintained to support and protect trees until they are able to stand alone.
- By the end of summer, the project landscape architect, botanist, ecologist, or land care professional is to prepare a detailed program and schedule of supplemental planting actions that must be implemented by fall or early winter to work with the best climate and planting season for native species.
- All supplemental planting actions are to be done with care and in a manner that minimizes disturbance to the adjacent soils and vegetation.

### **Irrigation**

- For native planting, use irrigation systems only for establishment and drought period. Limit summer water after establishment.
- For all plant material irrigation systems, a baseline irrigation watering schedule will be provided to meet the following requirements:
  - **Permanently Irrigated Landscape**
    - Establishment watering schedule is to meet the requirements and recommendations of the plant material provider.
    - Staged watering schedule should be designed to deepen plant root zone growth and ability to thrive on reduced supplemental watering schedule.
    - The proposed watering schedule should provide for future plant root zone growth and established requirements to promote healthy plant establishment and maturation.
  - **Establishment Irrigated Native Landscape**
    - Establishment watering schedule to meet the requirements and recommendations of the native seed and/or plant material provider.
    - Staged watering schedule designed to "harden off" plant materials over a three-year growth period to encourage deep, stable root growth and the ability to thrive on natural precipitation.
    - The proposed watering schedule will provide for future plant root zone growth and established requirements to promote healthy plant establishment and maturation.

# ECOLOGY, HABITAT, AND PLANTING CHECKLIST

Reference the LACFCD and Public Works Permitting checklist in Chapter 2 for an overview of project permitting and applicable codes.

- All irrigation systems shall be inspected throughout the year. See seasonal maintenance recommendations below.
- **Spring (seasonal system start-up as applicable)**
  - Prior to heavy summer irrigation system use, complete full system operational check to verify the following:
    - Confirm upcoming watering schedule accords with average weather conditions and upcoming plant establishment requirements.
    - Control system operation, connection to local weather station, rain sensor, master valve, and flow sensor.
    - Test the backflow prevention device for proper operation and protection of upstream water supply.
    - Integrity of mainline and lateral piping, repair leaks, and related failures.
    - Remote control valve operation.
    - Clean drip zone filter kits and test operation.
    - Review operation of each irrigation zone and adjust or repair each emission device for proper operation.
- **Summer**
  - Once monthly, operate each irrigation zone and repair or adjust as necessary to eliminate leaks, overspray onto hardscape areas, and other system casualties.
- **Fall (seasonal system shut down as applicable)**
  - Winterize the irrigation system in accordance with local regulation and manufacturer recommendations.

### **Pruning and Weeding**

- Invasive species growth shall be continuously monitored during the planting process. Perform weeding and supplemental mulching as necessary to prevent the spread of invasive species. The specific methods, products, and areas where weeding is proposed shall be approved by the project landscape architect. Refer to Los Angeles County Weed Management Area Best Management Practices manual.<sup>42</sup>
- All trees and shrubs shall be allowed to grow to their natural genetic form and size. Do not excessively prune plants. Limb tree branches to required height for USACE or LA County Flood Control District maintenance areas only once the trees have reached maturity.
- Include provisions for wildfire management and prevention:
  - Properly prune shrubs to reduce fuel load.
  - Reduce and remove invasive grasses and other invasive annuals which can increase fire risk.
- All pruning and weeding actions are to be done with care and in a manner that minimizes disturbance to the adjacent soils and vegetation.



Figure 298. Projects Along the LA River. A consistent cadence of XS, S, M, L, and XL projects occurs along the 51 miles of the LA River.



## 6.

# FACILITIES AND AMENITIES

Facilities and amenities along the LA River promote a sense of place and belonging along the river corridor. They are not only what draw people to the river, but also encourage them to stay for longer periods of time to enjoy the river with comfort and safety. These amenities, ranging from large pavilions to a single bench, are meant to be used by all people, including commuters, recreational users, nearby residents, and persons experiencing homelessness. Though the River Pavilions are a significant community resource and house a cluster of various amenities, a single drinking fountain along the multiuse river trail is just as vital to the experience of a person along the river. Most importantly, these facilities and amenities should strive for design excellence. Great design of these elements will elevate the experience of users along the river and offer opportunities for artwork. Additionally, they must be maintained, be visible, and occur at a consistent cadence so that people know what to expect along the river corridor. This consistency encourages community members to keep coming back and exploring the LA River.

In light of COVID-19, several lessons can be gleaned and incorporated into the design of facilities and amenities, including adequate ventilation and spacing. For example, single use bathrooms are encouraged to have ventilation and encourage social distancing. Multi-use trails are encouraged to be designed with space for users to step aside to allow room for passersby. Additionally, maintenance considerations can consider extra sanitation measures as required.

## WHAT'S IN THE CHAPTER

The following pages contain the information regarding the size, occupancy, program, and configuration of the different types of pavilions along the LA River. This chapter will also provide information regarding the types of site furnishings that are deemed acceptable to be used along the river. Consult the checklist at the end of the chapter to ensure the correct guideline items are followed.

<b>325</b>	<b>6. Facilities and Amenities</b>		
326	What's in the Chapter	358	Site Furnishings: Litter and Recycling Receptacles
328	River Pavilions		
330	Pavilion Cadence	359	Site Furnishings: Bike Racks
332	Pavilion Components	360	Site Furnishings: Benches
340	Pavilion Configurations	361	Site Furnishings: Drinking Fountains
342	Shade Pavilions (Tier I)		
346	Rest Pavilions (Tier II)	362	Site Furnishings: Lighting
350	Gathering Pavilions (Tier III)	365	Site Furnishings: Emergency Call Boxes
354	Pavilion Best Practices	366	Site Furnishings: Recreation
356	Common Elements: Site Furnishings	368	Facilities and Amenities Checklist



THE LA RIVER'S SHADE (TIER I),  
REST (TIER II), AND GATHERING  
(TIER III) PAVILIONS FORM A VARIED  
NETWORK OF COMMUNITY ASSETS  
THAT ACCESSIBLE TO ALL

---



## RIVER PAVILIONS

Pavilions situated along the LA River will house numerous facilities and amenities and will form a network of programs and activities to support a continuous and unified experience along the river trail. Pavilions serve as an asset for river users and river-adjacent communities. They should complement existing neighborhood assets, such as parks, schools, community facilities, neighborhood food vendors, public transit, and cultural organizations to form enriched nodes of interest. Furthermore, pavilions provide multiple opportunities for artwork including light, sound, virtual reality, and other temporary installations. Food culture, including neighborhood vendors and festivals, can be celebrated in these pavilions.

Other master plans and urban designs have already identified several sites for facilities and amenities, but additional pavilions are necessary to establish a regular and equitable cadence for all river users.

The architecture of the River Pavilions should meet the highest standard of design excellence. All pavilions should have a finish floor elevation above the 1% storm event level. If elevation at the 1% storm event level is not feasible, first consider other locations. If no other location is possible, consider making the facility floodable. Further, the maintenance planning for the pavilions is critical, as to best alleviate future operations and maintenance costs.





**Figure 300.** Lewis MacAdams Riverfront Park is one example of an existing pavilion along the LA River at river mile 26. Source: LA Public Works, 2018.

River Pavilions have been organized into three tiers based on the number and type of amenities provided. Pavilions with baseline amenities will occur more frequently in the cadence along the river, while pavilions with added amenities occur more intermittently at an appropriate cadence. Shade Pavilions (Tier I), the baseline, include seating, shade structures, drinking fountains, waste disposal, and an emergency call box. Rest Pavilions (Tier II) include the baseline amenities Shade Pavilion (Tier I) and restrooms, bike racks, picnic tables, charging stations, and vending machines, with optional barbecues and outdoor showers.

Gathering Pavilions (Tier III), include all Shade (Tier I) and Rest (Tier II) Pavilion amenities in addition to a cafe, indoor showers, lockers, public safety station, and bike rental and repair. Sports equipment rental, multipurpose rooms, and community kitchens can further enhance Gathering Pavilions (Tier III). Larger pavilions, in particular, operate as destinations in themselves attracting visitors to the river. More information on potential use of different pavilions can be found later in this chapter. Within each tier, pavilions can adjust in scale, configuration, and specific program to react to local site conditions and amenities that may already exist.



**CONSISTENTLY DISTRIBUTE PAVILIONS ALONG  
THE 51 MILES OF THE LA RIVER TO PROVIDE  
ESSENTIAL FACILITIES AND AMENITIES  
WITHIN REACH OF ALL OF THE RIVER'S USERS  
AND NEIGHBORING COMMUNITIES**

---

## **PAVILION CADENCE**

A network of pavilions along the LA River should adhere to a cadence that optimizes an equitable distribution of facilities and amenities for river users and river-adjacent communities.

Ideally, Shade (Tier I) and Rest (Tier II) Pavilions alternate every 1/2 mile along both sides of the river where feasible, with the exception of gaps in the river trail. Shade (Tier I) and Rest (Tier II) Pavilions should have a spacing tolerance of 1/10th of a mile to provide adequate flexibility in selecting appropriate and favorable sites. The 1/2 mile spacing affords river users shaded seating within an approximate five-minute walk in either direction. The one-mile spacing between Rest Pavilions (Tier II) in particular provides river users a restroom facility within an estimated ten-minute walk in either direction.

Located every 2-3 miles on either side of the river, Gathering Pavilions (Tier III) should be located in conjunction with river gateway access points, enhancing their accessibility to river-adjacent communities. The spacing of the pavilions is intended to create a consistent cadence of amenities without creating redundancy. The spacing tolerance of 1/10th of a mile helps

equalize the distribution of facilities and amenities. For example, if a Gathering Pavilion (Tier III) falls within 1/2 mile of a Shade (Tier I) or Rest (Tier II) Pavilion, the smaller pavilion should move 1/10th of a mile away from the larger one.

Upon full implementation of the LA River Master Plan, pavilions will regularly stand on both banks of the river along its continuous 51 miles of connected open space. The spacing of pavilions on opposite riverbanks does not need to align with one another. Instead, it is more important that pavilions situate appropriately in their context, instead of adhering to a rigid plan at the expense of more logical and strategic placement. Further, additional pavilions can supplement the baseline cadence to respond to community needs and increased visitation.

Urban context should further inform site selection and the orientation of pavilions. Optimized placement of pavilions enhances the river's relationship to the river itself, along with proximate streets, crossings, parks, community facilities, and public transportation. River users should have a plethora of facilities and amenities within every frame, along both banks of the river.

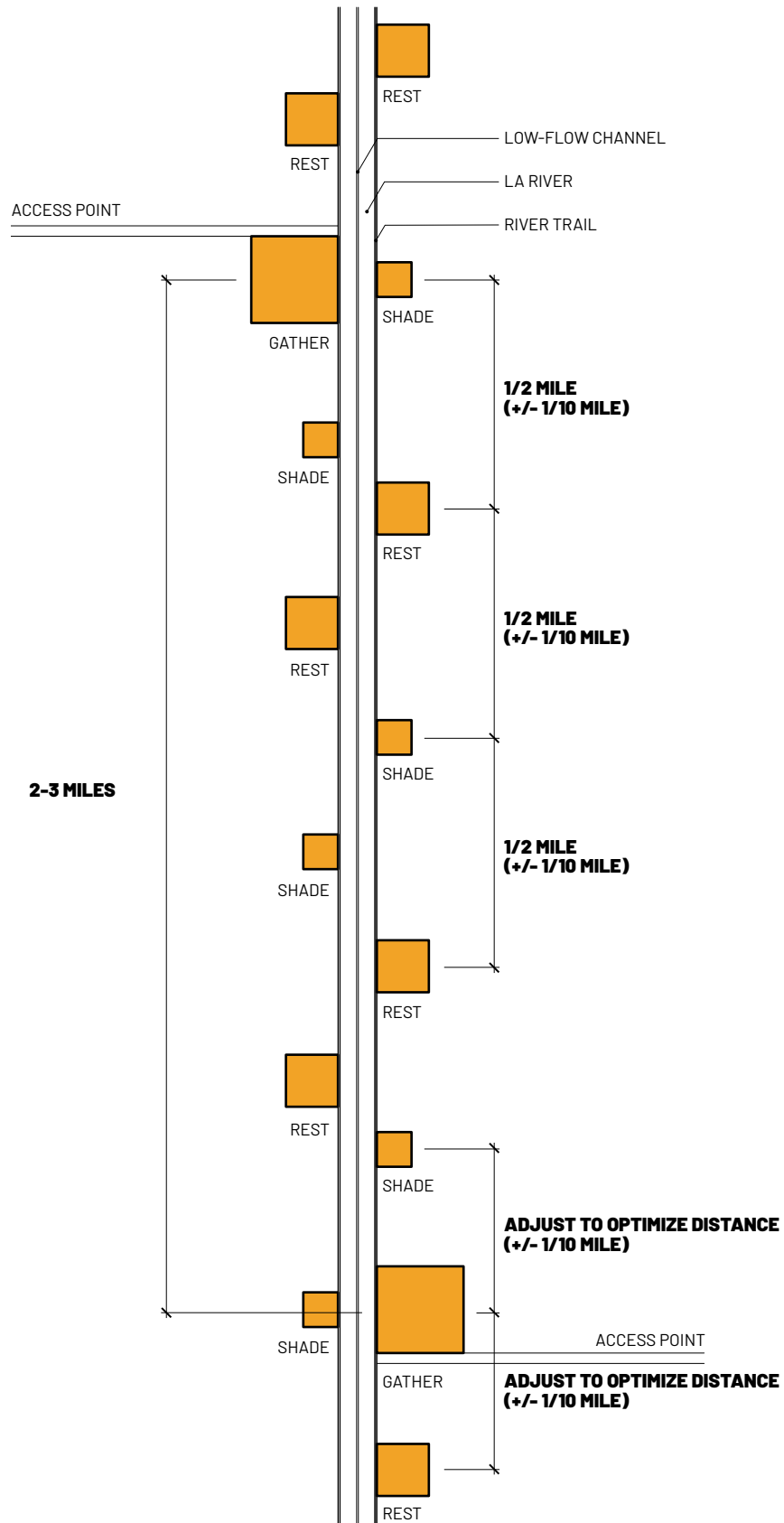


Figure 301. Shade, Rest, and Gathering Pavilions all occur at a consistent cadence along the river. A base level of amenities are to be installed at a minimum of every half mile along each bank of the river.

SHADE PAVILIONS (TIER I) = A  
 REST PAVILIONS (TIER II) = A + B  
 GATHERING PAVILIONS (TIER III) = A + B + C

## PAVILION COMPONENTS

Shade (Tier I), Rest (Tier II), and Gathering (Tier III) Pavilions are composed of a variety of facilities and amenities determined by three designated tiers of components A, B, and C. A and several B components are exterior amenities, such as street furniture. The remaining B and C components are interior elements that require enclosed space. All components can provide an opportunity for artwork.

Pavilions implementing sanitation facilities (B and C components) should give preference to the use of gender-neutral, single-occupancy spaces, i.e., restrooms, lockers, and showers. Single-occupancy facilities afford users enhanced privacy and dignity. This is particularly important as facilities serve vulnerable populations, notably persons experiencing homelessness. If local building codes require single-sex facilities, supplement them with single-occupancy facilities, family restrooms, and mother's rooms.

The representation of components is diagrammatic and not prescriptive. Instead, the illustrations and accompanying dimensions provide a general sense of size, configuration, and scale. Through the development of pavilions, these components will likely take on varying configurations and must reflect individual site constraints, programmatic needs, and other outlying factors.

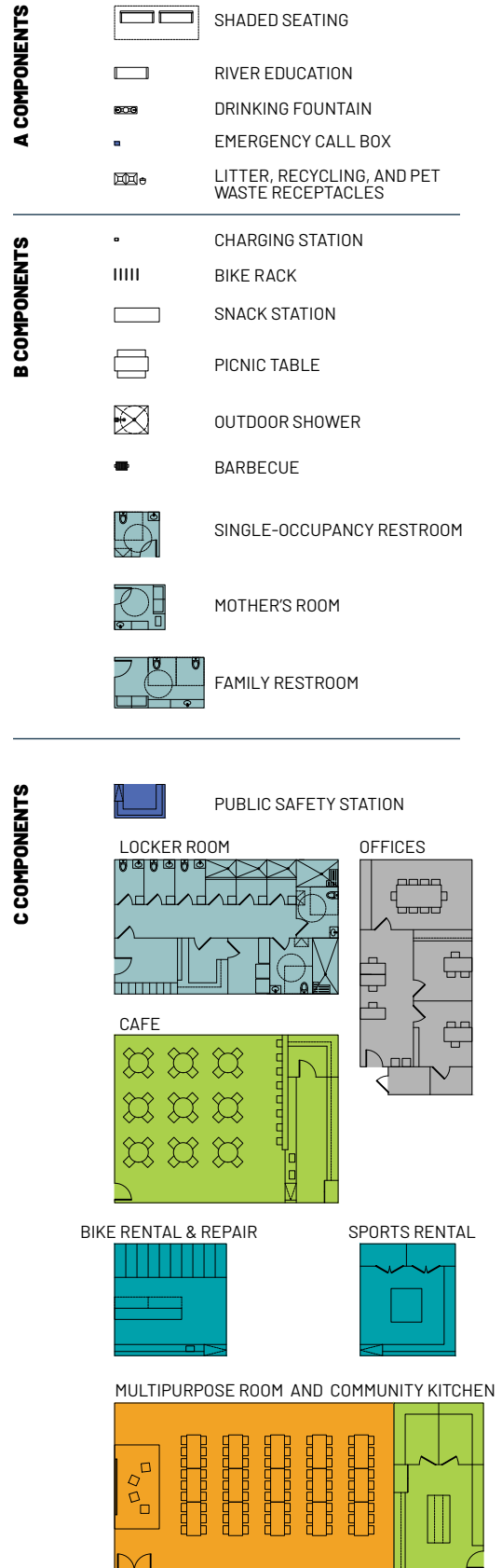
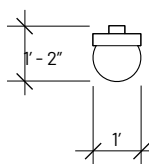
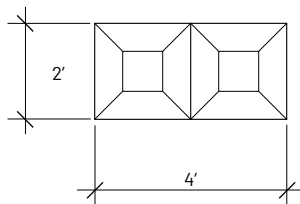
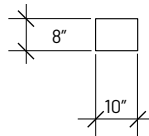
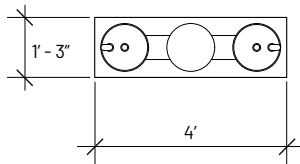
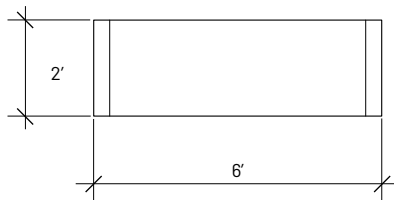
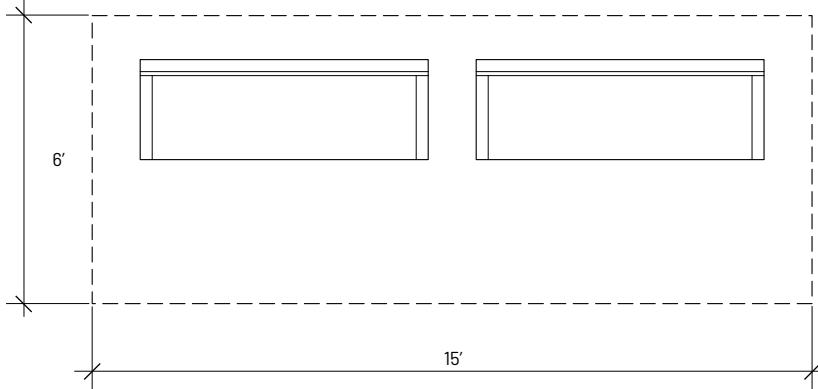


Figure 302. Pavilion A, B, and C components range in size and programming from shade and drinking fountains to restrooms and community kitchens.

## A COMPONENTS



### SHADE STRUCTURE & SEATING

- Preference for shade structures with adequate ventilation
- Shade can also be provided by mature canopy trees
- Provides protection from inclement weather
- Easily accessible from trail
- Seating grouped to promote social interaction

### RIVER EDUCATION

- Clear and accessible display
- Consistent environmental graphics along the length of the entire river (see chapter 4)

### DRINKING FOUNTAIN (PG 289)

- Standard and accessible spout
- Water bottle filler
- Optional dog drinking faucet and bowl

### EMERGENCY CALL BOX (PG 291)

- Easily visible and accessible
- Strobe light for emergencies
- Optional solar power

### LITTER AND RECYCLING (PG 288)

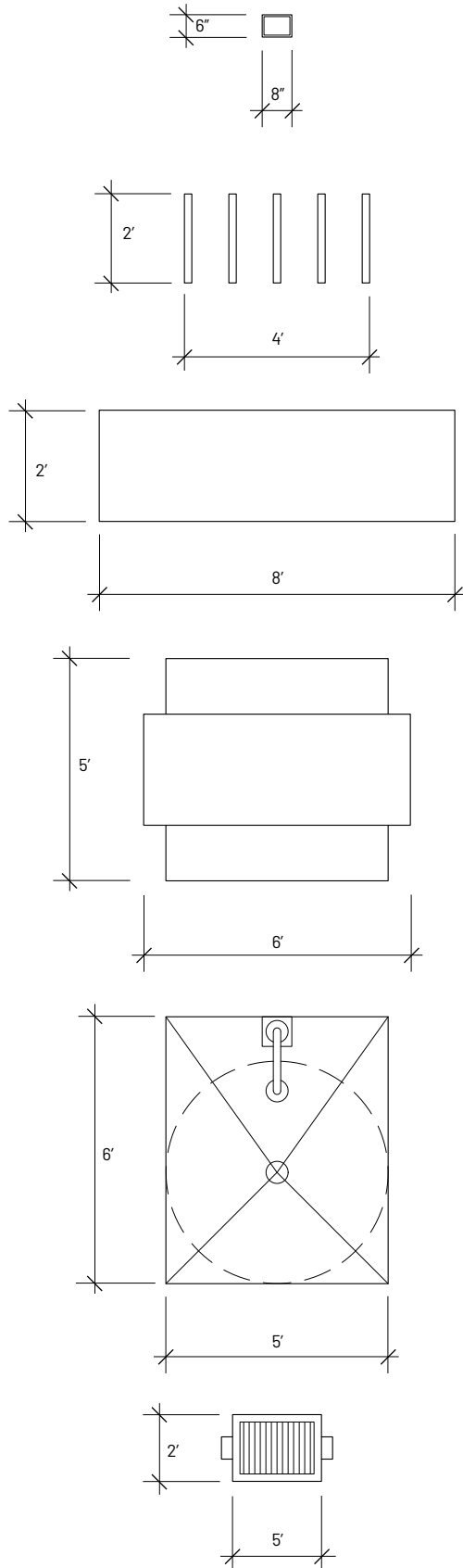
- Located near entrances
- Dual trash/recycling bin to coordinate with municipal maintenance operations

### PET WASTE STATION

- Pet waste bag dispenser
- Small trash receptacle
- Clear environmental graphics

Figure 303. The basic components of a Shade Pavilion include shade, seating, and drinking fountains. Various components are illustrated here and dimensions are shown as general guides, not exact requirements.

## B COMPONENTS



### CHARGING STATION

- Dual USB rapid-charge ports
- Universal charging cords
- Wireless charging capable

### BIKE RACK

- Provide 6 feet of length for bikes and an additional 5-foot unobstructed clearance for bike parking

### SNACK STATION

- Offer healthy and affordable beverages and snacks
- Promote local food entrepreneurs, suppliers, and distribution

### PICNIC TABLE

- Aggregated into picnic areas
- Preferred table configurations for 2, 4, 6, 8, and 10 persons per table
- Do not fix all tables to the ground

### RECREATIONAL OUTDOOR SHOWERS (OPTIONAL)

- Optimal for pavilions adjacent to pools, splash pads, kayaking, and other sports recreation amenities
- Time-flow valve shower heads
- Add hooks for personal items
- Optional pet wash attachment

### BARBECUE (OPTIONAL)

- Distributed across picnic areas
- Provide adequate space for ventilation and safety
- Do not include in fire hazard areas or areas of dense vegetation

0' 2' 4'

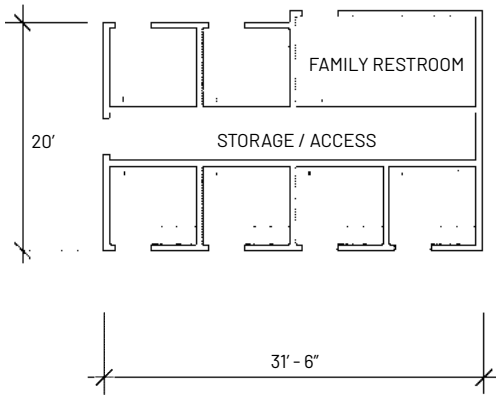
Figure 304. The basic components of a Rest Pavilion include restrooms, bike racks, and a snack station. Dimensions are general guides and not exact requirements.



**TIER II - BASIC SANITATION FACILITIES**

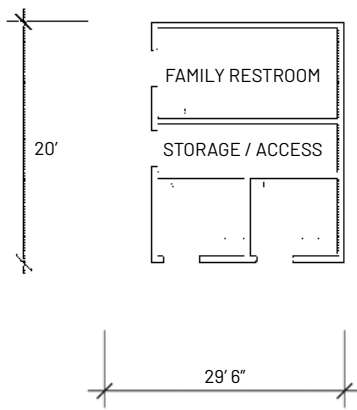
**SINGLE OCCUPANCY | LARGE**

- Modular and standardized
- 6 restrooms
- 1 family restroom
- Changing station
- Storage and access room
- Modular and standardized



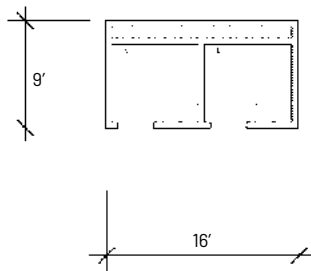
**SINGLE OCCUPANCY | MEDIUM**

- Modular and standardized
- 2 restrooms
- 1 family restroom
- Changing station
- Storage and access room
- Modular and standardized



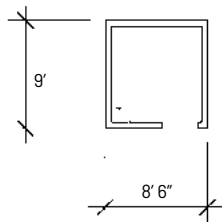
**SINGLE OCCUPANCY | SMALL**

- 2 restrooms
- Changing station
- Access shaft for plumbing
- Modular and standardized



**MOTHER'S ROOM (OPTIONAL)**

- Changing station
- Seating and space for nursing
- Bottle warmer
- Modular and standardized



**STORAGE ROOM (PREFERRED)**

- Storage and cleaning supplies
- Utility sink and counter space
- Space for bathroom attendant

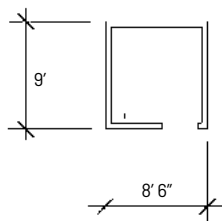
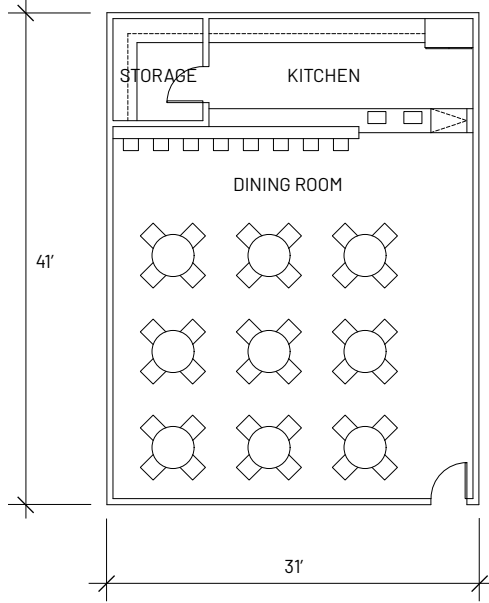


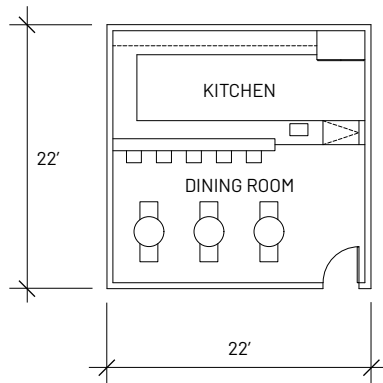
Figure 305. Restrooms should consist of single occupancy stalls, preferably including both a storage room and a mother's room. Various components are illustrated here and dimensions are shown as general guides, not exact requirements.

## C COMPONENTS



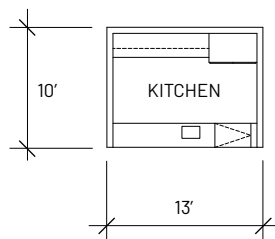
### CAFE | LARGE

- Appropriate for large pavilion with other significant program
- Table seating and counter service
- Full service kitchen capable of on-site preparation
- Take-out / ready-made counter
- Separate food storage



### CAFE | MEDIUM

- Appropriate for small and medium pavilions
- Limited table seating and counter service
- Kitchen capable of basic on-site preparation
- Take-out / ready-made counter



### CAFE | SMALL

- Appropriate for small pavilions and outdoor picnic areas
- No indoor seating
- Limited on-site preparation
- Take-out / ready-made counter



Figure 306. The basic components of a Gather Pavilion include a programed element such as a cafe or community center. Cafes can vary in size depending on the project site. Dimensions are general guides and not exact requirements.

**TIER III - ENHANCED SANITATION FACILITIES**

**SINGLE-SEX LOCKER ROOM**

- Utilize single-sex locker room configurations only when required by local building code
- Provides an efficient and centralized use of space
- Does not afford users the same level of privacy as single occupancy showers, restrooms, or changing areas
- On-site attendant required
- Customized to pavilion

**UNISEX LOCKER ROOM**

- Preferred configuration to increase sense of privacy
- Should separate restrooms from showers as they have varied time of visitorship
- On-site attendant required
- Customized to pavilion

**FAMILY LOCKER ROOM**

- Lockers and showers
- Adult and child's height toilets
- Seating and space for nursing
- Changing table
- Customized to pavilion

**RENTAL & SERVICE STATION**

- Station to rent towels and purchase toiletry items
- Laundry and storage for maintenance
- Customized to pavilion

**SINGLE OCCUPANCY FACILITIES**

- Increased sense of privacy
- Separate facilities for lockers, restroom, and shower
- Customized to pavilion

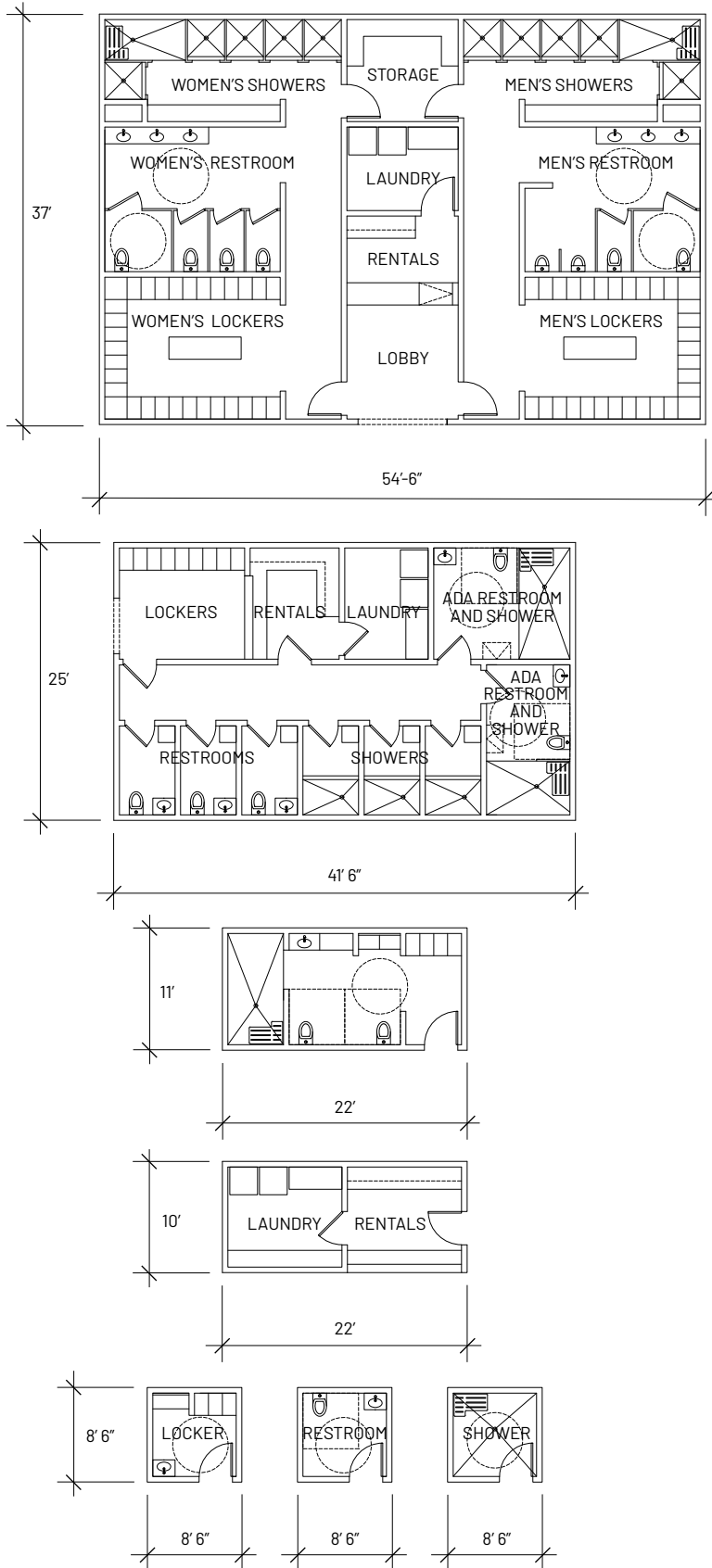
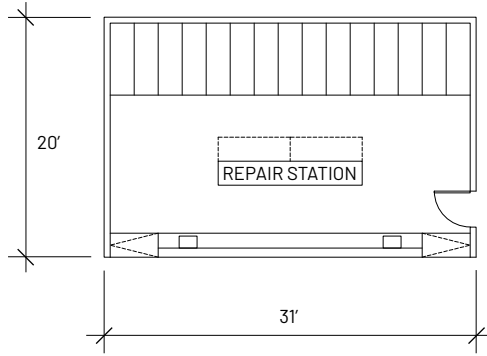
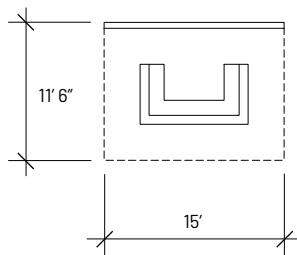


Figure 307. Locker rooms in Gather Pavilions may not be able to provide single use occupancy restrooms or locker stalls, although they are preferred if possible. Various components are illustrated here and dimensions are shown as general guides, not exact requirements.



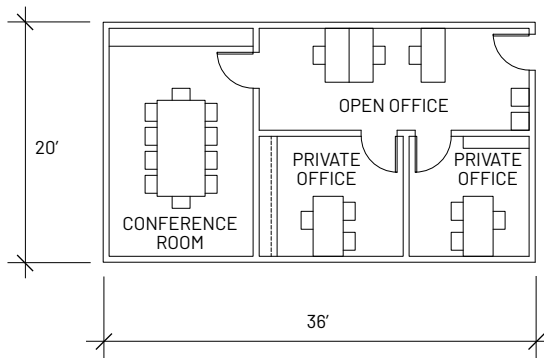
### BIKE RENTAL & REPAIR

- Can be either indoor or outdoor
- Station for river users to rent bike and inflate tires
- Provide adequate space, floor and counter, for bike repairs



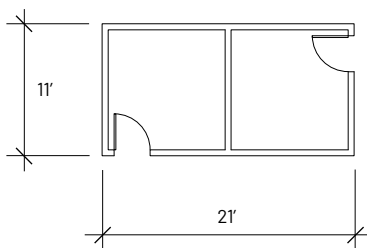
### PUBLIC SAFETY STATION

- Visible station for public safety or police officer
- Can also serve as an LA River concierge with information on events and activities along the river



### MANAGEMENT OFFICES (OPTIONAL)

- Provide offices and conference room for pavilion management operations and staff
- Located away from public function
- Connect to storage room as necessary

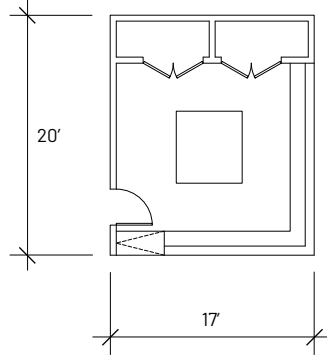


### FACILITIES STORAGE (OPTIONAL)

- Configuration dependent on pavilion size and storage needs
- Provide storage for general facility needs and management offices

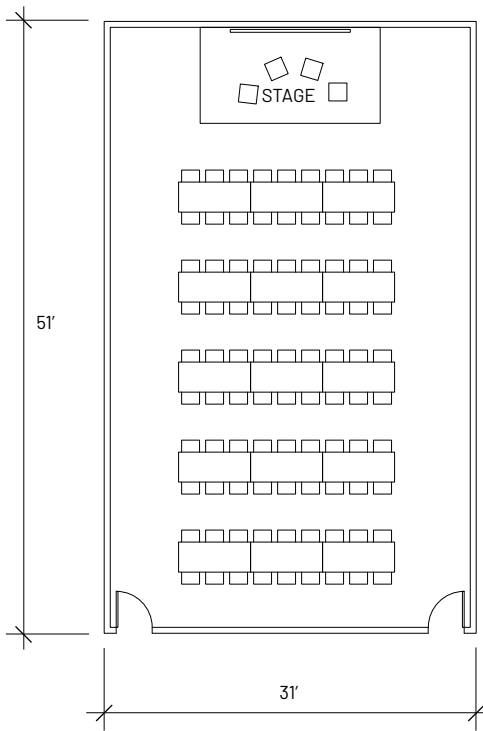


Figure 308. Gather Pavilions may include a bike repair and rental shop or a public safety station. Supporting facilities such as management offices or additional storage can also be included. Dimensions are general guides and not exact requirements.



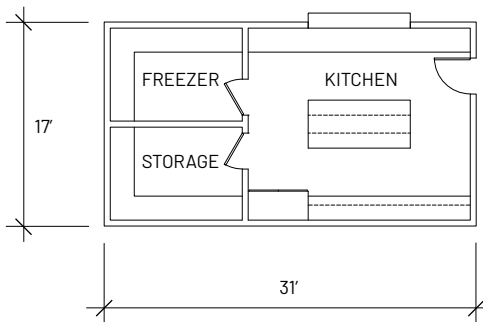
**SPORTS EQUIPMENT RENTAL (OPTIONAL)**

- Short-term rentals of sports equipment adjacent to major recreational areas
- Incorporate horizontal and vertical storage



**MULTIPURPOSE ROOM (OPTIONAL)**

- Flexible space for events such as parties, lectures, meetings, community engagement, and performances
- Can be combined with a community kitchen to support events and dining activities
- Optional room dividers for concurrent events



**COMMUNITY KITCHEN (OPTIONAL)**

- Flexible kitchen space for food preparation for events and culinary education
- Servery to multipurpose room
- Commercial grade appliances



Figure 309. Gather Pavilions may include rooms that can be of general use to the community, such as a community kitchen or multipurpose room. Various components are illustrated here and dimensions are shown as general guides, not exact requirements.



**ALL PAVILIONS SHOULD RESPOND TO THEIR  
SITE CONSTRAINTS WHILE PROVIDING  
ADEQUATE FACILITIES AND AMENITIES TO  
THE ADJACENT RIVER TRAIL, EXISTING  
PUBLIC RESOURCES, AND CONTEXT**

---

## PAVILION CONFIGURATIONS

There are numerous ways to configure A, B, and C Components into the varying Shade (Tier I), Rest (Tier II), and Gathering (Tier III) Pavilions. Sample configurations demonstrate different planar organizations appropriate for discrete site constraints and desired results: Compact-Linear, Compact-Square, Moderate, and Expanded.

Compact-Linear and Compact-Square configured pavilions represent the baseline facilities and amenities required per tier. Compact-Linear pavilions are most appropriate in constricted sites, such as those within an existing, narrow right-of-way or a future cantilever constructed above the river channel. Compact-Linear configurations optimize pavilions' river frontage. Compact-Square pavilions are more appropriate for larger, less-constrained sites.

Moderate configurations incorporate additional amenities and larger facilities into more spacious pavilions, which include multiple shade structures for seating and larger picnic areas. Similarly, expanded configurations further integrate enlarged facilities and increased amenities, but also include optional programs from the pavilion components, such as outdoor showers and barbecues in Rest Pavilions (Tier II) and the multipurpose room and community kitchen of Gathering Pavilions (Tier III). Expanded configurations require significant land area and have a higher development cost, but become enhanced resources to river users and river-adjacent communities.

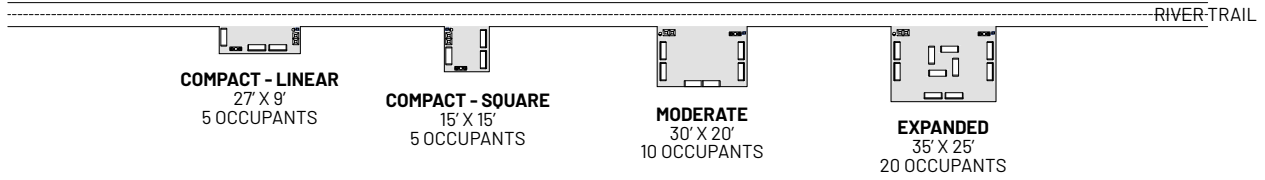
The occupancy of River Pavilions will range from 5 to 500 occupants depending on program and square footage. An occupant load factor is used to determine a maximum occupation of different programmed spaces. Occupant load

factors should reflect the prevailing International Building Code or the local building code of the site's jurisdiction, adhering to whichever is more restrictive. Shade Pavilions (Tier I) are single-use structures and therefore utilize a single occupant load factor. However, Rest (Tier II) and Gathering (Tier III) Pavilions are multiuse, necessitating multiple occupancy calculations as determined by each significant program, i.e., restrooms, locker rooms, rental stations, offices, cafe, multipurpose room, and kitchen.

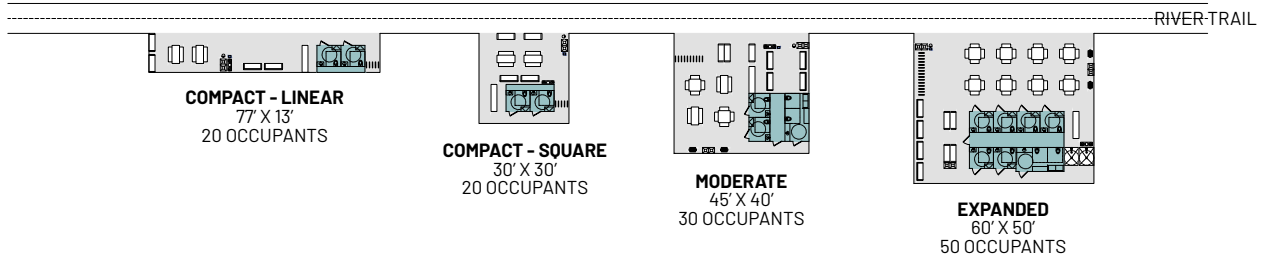
Use discretion when assigning occupant load factors to the varying programs. For example, a kiosk cafe without patron seating will have a significantly lower occupant load factor and thus occupancy than an enclosed cafe with a service counter, tables, and chairs. Further, flexible programs can have varied configurations and thus differing occupant load factors. For example, a multipurpose room can be configured loosely for events with tables and chairs, moderately with unfixed seating, and tightly with standing room only. Utilize the occupant load factor for spaces in the most confined configuration anticipated.

Shade (Tier I), Rest (Tier II), and Gathering (Tier III) Pavilions must adhere to the following prevailing standards: Federal, state and county requirements, such as California's Title 24 Part 6 Building Energy Efficiency Standards, and local building codes, zoning regulations, and parking requirements. Moreover, the development of pavilions should reflect a commitment to serve the entirety of river users and make necessary accommodations for universal access.

**SHADE PAVILIONS (TIER I)**



**REST PAVILIONS (TIER II)**



**GATHERING PAVILIONS (TIER III)**

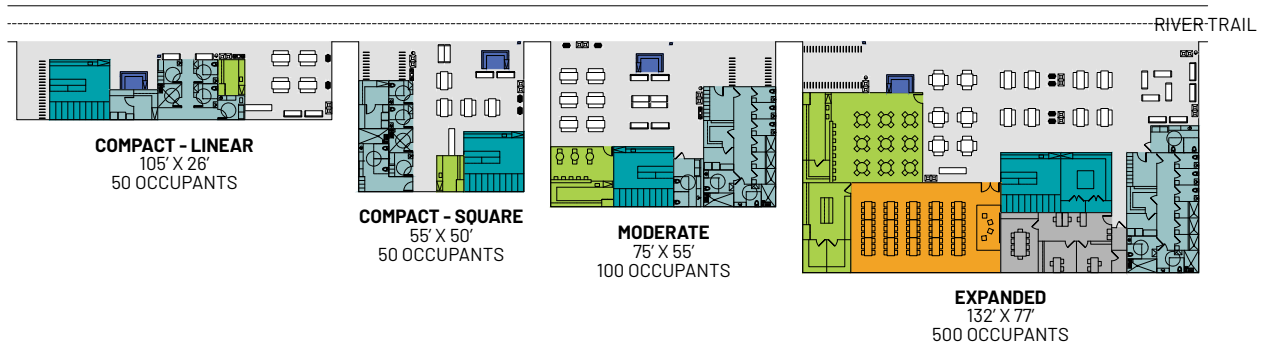


Figure 310. Pavilions can be configured in a variety of footprints ranging from compact linear to expanded depending on the project site.

Shade Pavilions (Tier I)

- Compact | Linear (27' x 9'): 5 occupants
- Compact | Square (15' x 15'): 5 occupants
- Moderate (30' x 20'): 10 occupants
- Expanded (35' x 25'): 20 occupants

Gathering Pavilions (Tier III)

- Compact | Linear (105' x 26'): 50 occupants
- Compact | Square (55' x 50'): 50 occupants
- Moderate (75' x 55'): 100 occupants
- Expanded (132' x 77'): 500 occupants

Rest Pavilions (Tier II)

- Compact | Linear (77' x 13'): 20 occupants
- Compact | Square (30' x 30'): 20 occupants
- Moderate (45' x 40'): 30 occupants
- Expanded (60' x 50'): 50 occupants



Figure 311. This exemplified design of Shade Pavilion (Tier I) at river mile 14.7 demonstrates how trail users can be welcomed with environmental graphics, an accessible ramp entrance, and amenities such as bike racks and drinking fountains.

## SHADE PAVILIONS (TIER I)

Shade Pavilions (Tier I) are the smallest of the River Pavilions. They provide shade and seating options along the length of the river, in addition to river education, drinking water, emergency call boxes, trash and recycling bins, and pet waste disposal. Shade Pavilions (Tier I) do not hold a robust program, but instead serve river users as a site of refuge, appropriate for moments of shade respite, shelter during passing inclement weather, and comfort. Shade can be provided both by structures and by mature canopy trees. They may take on a number of different configurations, dependent on their site constraints, urban context, and desired orientation. Shade Pavilions (Tier I) are small, but are essential in creating a consistent identity and robust implementation of LA River facilities and amenities.

**SHADE PAVILIONS (TIER I) PROVIDE SHELTER AND REFUGE TO VISITORS OF THE LA RIVER AND ALSO PROVIDE OPPORTUNITIES FOR RIVER EDUCATION**



PAVILION RAMP

PAVILION  
ART WALL

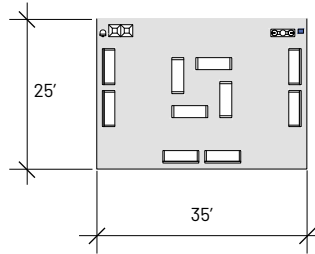
PAVILION STAIRS

LA RIVER  
CHANNEL

Figure 312. The plan of the Shade Pavilion (Tier I) example at river mile 14.7 shows how multiple points of access are provided to the LA River multiuse trail.

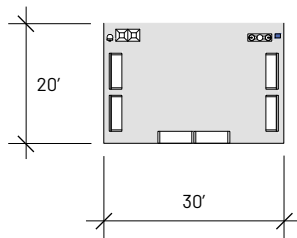
30'

N



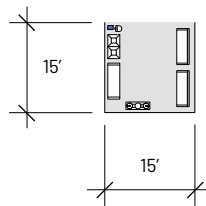
**EXPANDED**

- Approximately 20 occupants
- Approximately 900 square feet
- Arranges covered seating for to encourage socialization
- Enhanced river education area
- Seating orientated facing and away from river and parallel and perpendicular to trail



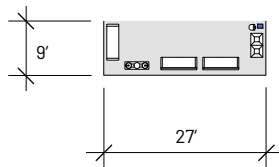
**MODERATE**

- Approximately 10 occupants
- Approximately 600 square feet
- Arranges covered seating for to encourage socialization
- Seating orientated away from river and perpendicular to trail



**COMPACT | SQUARE**

- Approximately 5 occupants
- Approximately 250 square feet
- Seating orientated away from river and perpendicular to trail



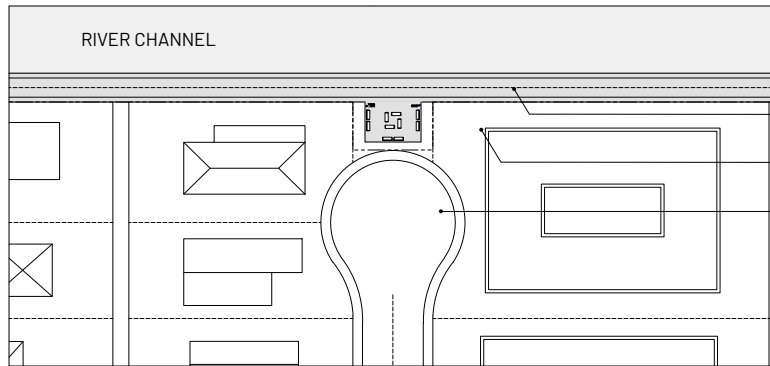
**COMPACT | LINEAR**

- Approximately 5 occupants
- Approximately 250 square feet
- Seating oriented toward river and parallel to trail



Figure 313. The Shade Pavilion (Tier I) can be configured in a variety of footprints from compact to expanded, depending on the project site and other constraints.

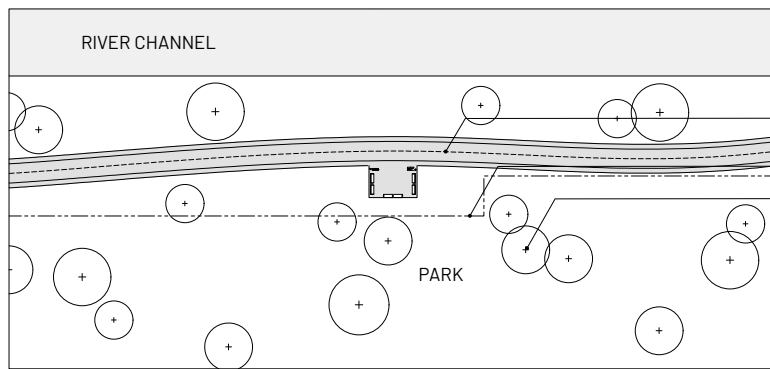




**EXPANDED**

- Sits at the end of a cul-de-sac

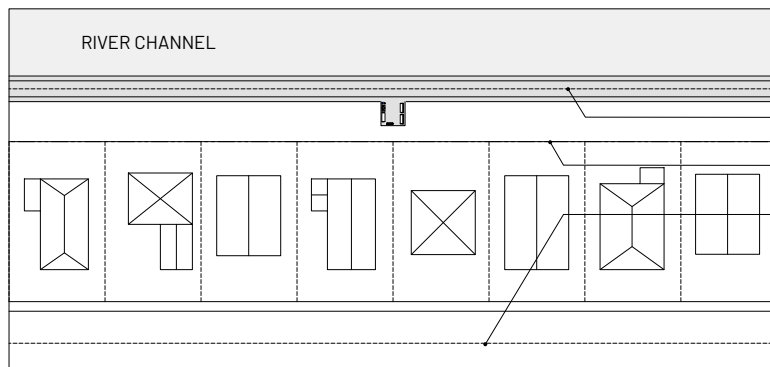
- MULTI-USE TRAIL
- RIGHT-OF-WAY FENCE LINE
- CUL-DE-SAC



**MODERATE**

- Situated within a park

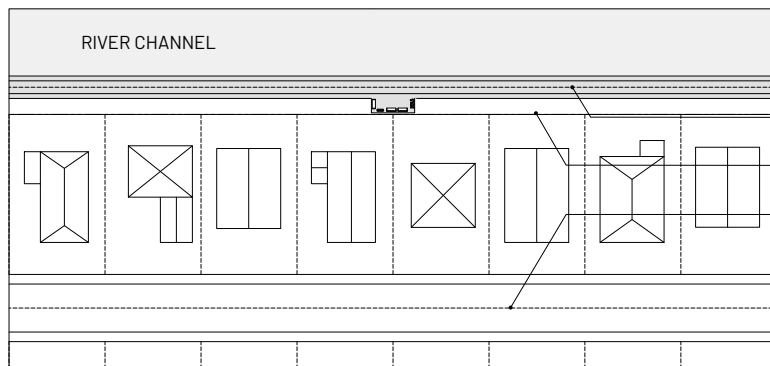
- MULTI-USE TRAIL
- RIGHT-OF-WAY FENCE LINE
- TREES



**COMPACT | SQUARE**

- Behind residential backyards

- MULTI-USE TRAIL
- RIGHT-OF-WAY FENCE LINE
- RESIDENTIAL STREET



**COMPACT | LINEAR**

- Behind residential backyards

- MULTI-USE TRAIL
- RIGHT-OF-WAY FENCE LINE
- RESIDENTIAL STREET



Figure 314. These example plans show how the Shade Pavilion (Tier I) can be implemented in a variety of urban contexts along the LA River.



Figure 315. The example design for a Rest Pavilion (Tier II) at river mile 50.9 welcomes users through pavement markings, a picnic area, and a local food vendor. Public restrooms are an important feature of Rest Pavilions.

## REST PAVILIONS (TIER II)

Rest Pavilions (Tier II) offer enhanced facilities and amenities beyond the baseline Shade Pavilions (Tier I), but fewer than Gathering Pavilions (Tier III). The most notable addition is restrooms. There should be a preference for single-occupancy restrooms and family restrooms, to provide greater privacy and dignity to all users. To increase efficiency and recognizability, Rest Pavilions (Tier II) should implement modular restrooms configurations that can be fabricated off-site, customized to incorporate graphic standards established along the LA River, and have an extensive presence across its 51 miles on both river banks. The modularity of the restrooms enhances the river's unification, pavilion familiarity, and equity for all river users.

Rest Pavilions (Tier II) also incorporate picnic areas, vending machines for healthy and affordable snacks and beverages, universal charging stations, and bike racks. Depending on their size and context, they may also include barbecues and recreational outdoor showers, which are particularly beneficial if the pavilion is adjacent to pools, other water features, or sports facilities. These pavilions serve as accessory facilities and amenities for river users, enabling relief, rest, and sustenance.

Regular maintenance is essential to preserve the upkeep of these facilities. In their implementation across the river, it is essential to consider materials that are durable, easily cleaned, and vandal-resistant, lessening long-term maintenance costs. Further, it is important to regularly operate and survey them to deter people from misappropriating their use. In facilitating welcoming, comfortable, and familiar structures, Rest Pavilions (Tier II) can establish a cadence of refuge along both banks of the LA River. They can create an accessible environment, in which river user and river-adjacent community needs are met.

**REST PAVILIONS (TIER II), SPACED ON AVERAGE ONE MILE APART FROM OTHER TIER II PAVILIONS, FORM A RELIABLE NETWORK OF RESTROOM FACILITIES, PROVIDING RIVER USERS GREATER COMFORT AND IMPROVING SANITATION ALONG THE LA RIVER**



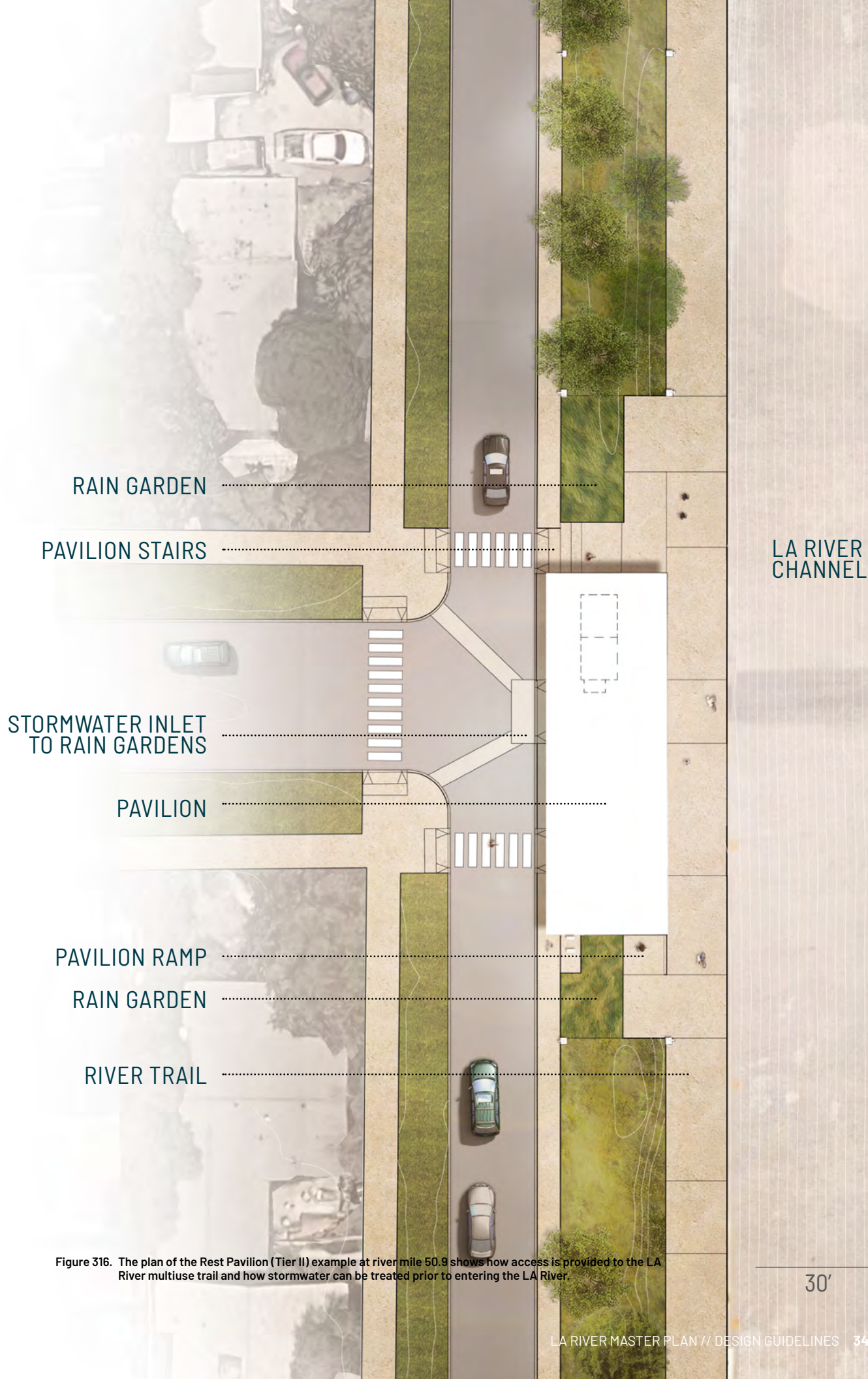
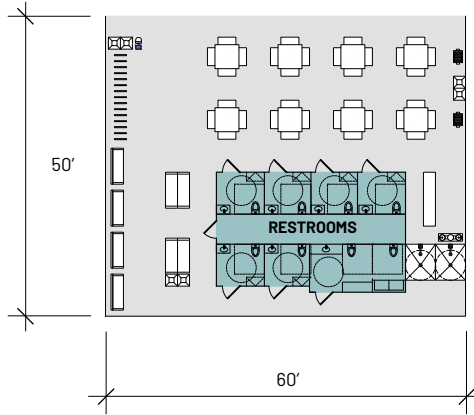


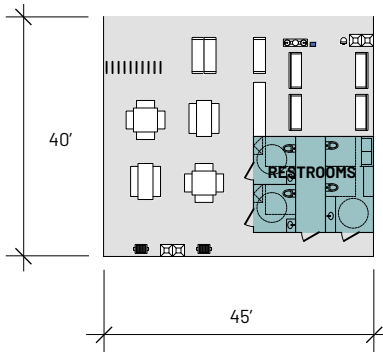
Figure 316. The plan of the Rest Pavilion (Tier II) example at river mile 50.9 shows how access is provided to the LA River multiuse trail and how stormwater can be treated prior to entering the LA River.

30' ↗



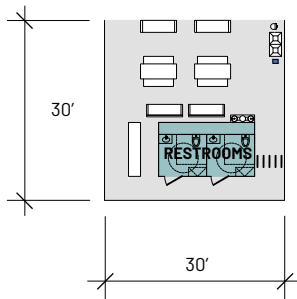
**EXPANDED**

- Approximately 50 occupants
- Approximately 3,000 square feet
- Additional shaded seating and picnicking tables
- Optional barbecues and recreational outdoor showers
- Supplement with family restroom(s) and storage



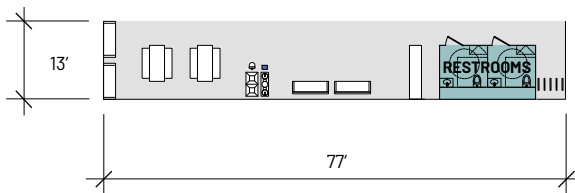
**MODERATE**

- Approximately 30 occupants
- Approximately 2,000 square feet
- Additional shaded seating and picnicking tables
- Optional barbecues and recreational outdoor showers
- Includes family restroom or mother's room



**COMPACT | LINEAR**

- Approximately 20 occupants
- Approximately 1,000 square feet
- No outdoor showers or barbecues

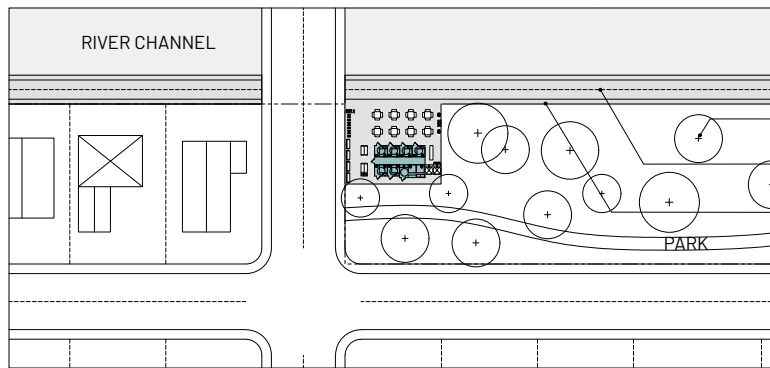


**COMPACT | LINEAR**

- Approximately 20 occupants
- Approximately 1,000 square feet
- No outdoor showers or barbecues
- Oriented toward river



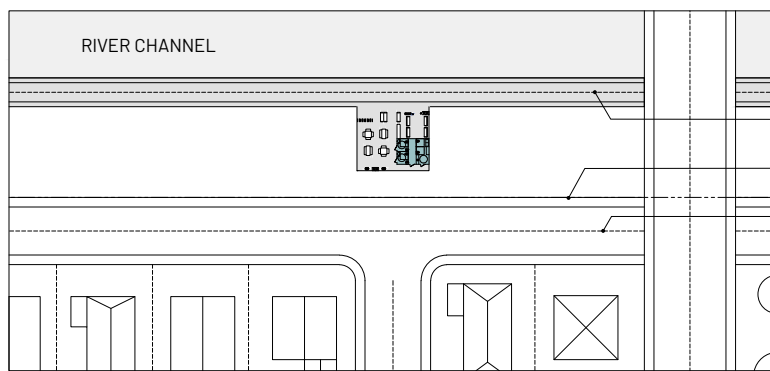
Figure 317. The Rest Pavilion (Tier II) can be configured in a variety of footprints from compact to expanded, depending on the project site and other constraints.



**EXPANDED**

- Next to crossing, within park

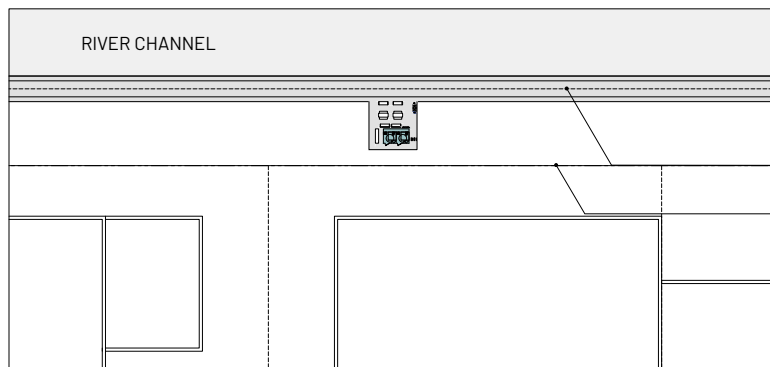
TREES  
 MULTIUSE TRAIL  
 RIGHT-OF-WAY FENCE LINE



**MODERATE**

- Across residential streets

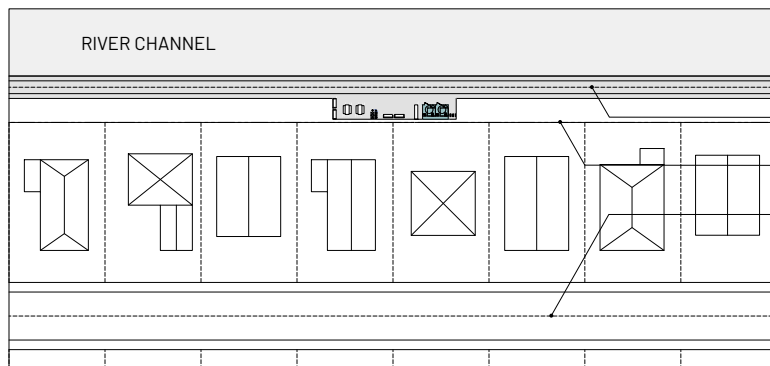
MULTIUSE TRAIL  
 RIGHT-OF-WAY FENCE LINE  
 RESIDENTIAL STREET



**COMPACT | SQUARE**

- Adjacent to industrial sites

MULTIUSE TRAIL  
 RIGHT-OF-WAY FENCE LINE



**COMPACT | LINEAR**

- Behind residential backyards

MULTIUSE TRAIL  
 RIGHT-OF-WAY FENCE LINE  
 RESIDENTIAL STREET



Figure 318. These example plans show how the Rest Pavilion (Tier II) can be implemented in a variety of urban contexts along the LA River.





**Figure 319.** This example design for a Gathering Pavilion (Tier III) at river mile 28.4 includes a cafe overlooking the LA River. Gather Pavilions often include community programming that requires expanded facilities.

## GATHERING PAVILIONS (TIER III)

Gathering Pavilions (Tier III) are the largest of the River Pavilions and can serve as significant hubs for programming and activity. Ideally situated every 2-3 miles at the access points to the LA River, these pavilions are accessible to both river users and adjacent community members. Expanded Gathering Pavilions in particular can support river-adjacent neighborhoods as community centers with robust facilities, amenities, and opportunities for events, education, and engagement.

Gathering Pavilions (Tier III) also offer enhanced sanitation facilities including restrooms, showers, lockers, and changing facilities. Locker rooms, paired with attendant stations, should have regular on-site maintenance to preserve their upkeep and deter misuse. Further, they have rental kiosks to provide river users towels for rent, in addition to soap, shampoo, conditioner, and other toiletries for purchase. Unlike Rest Pavilions (Tier II), sanitation facilities in Gathering Pavilions (Tier III) should be customized to best relate to the specific organization of other spaces within the pavilion.

These sanitation facilities provide multiple benefits and can help alleviate the sanitation needs of persons experiencing homelessness.

Currently, many of these individuals have limited access to sanitation facilities and as the county and river-adjacent cities make further investments to construct affordable housing and permanent supportive housing for persons experiencing homelessness, Gathering Pavilions (Tier III) can serve in the interim as spaces to support this vulnerable population's sanitation needs. However, upon their development and long-term, locker rooms can serve the needs of everyone along the length of the river, especially those engaging in athletic activity. Gathering Pavilions (Tier III) will supplement the active needs of river users outside of the building itself, such as soccer, dance and theater arts, cultural festivals, food culture, sporting events, yoga classes, and jogging along the trail.

Gathering Pavilions (Tier III) are centralized hubs for the LA River. Their optional multipurpose rooms can be utilized for community events, ceremonies, and other large gatherings. They should also have enough hardscaped floor area to similarly host outside events and ceremonies. Unlike smaller pavilions, they can support on-site management staff to establish daily programming and robust community offerings. The pavilions must be flexible for different needs, programs, and activities to optimize the development of the river at large.





RIVER TRAIL

LA RIVER CHANNEL

CAFE

COURTYARD

HYGIENE FACILITIES AND LOCKERS

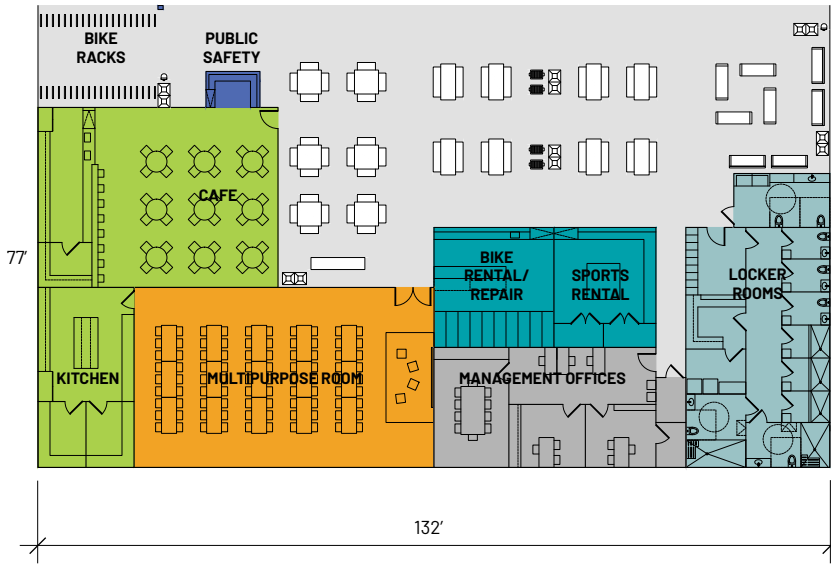
BIKE RENTAL & REPAIR

EXISTING BICYCLE BRIDGE

Figure 320. The plan of the Gathering Pavilion (Tier III) example at river mile 28.4 shows how multiple facilities can be incorporated onto a project site.

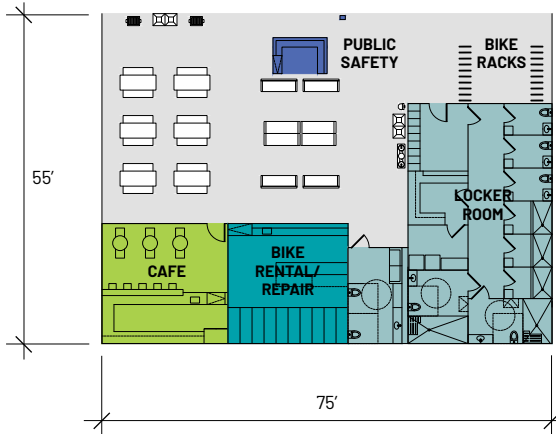
30° N

PREFERRED



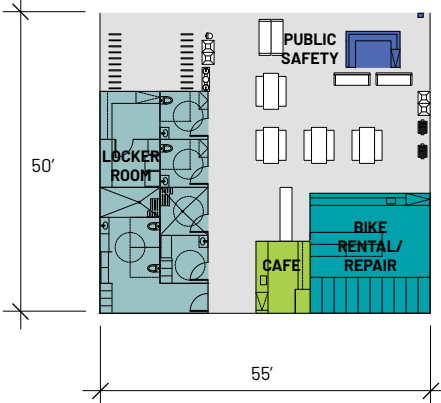
**EXPANDED**

- Approximately 500 occupants
- Approximately 10,500 square feet
- Enlarged cafe and locker room
- Multipurpose room and community kitchen provides large, flexible event space
- Includes sports equipment rental to supplement adjacent sports fields and courts
- If using single-sex locker rooms, supplement with family locker room



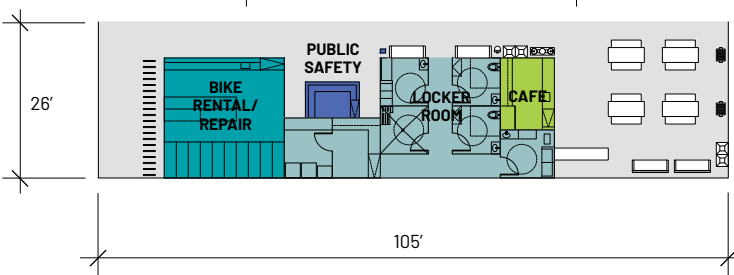
**MODERATE**

- Approximately 100 occupants
- Approximately 4,500 square feet
- Enlarged cafe and locker room
- No multipurpose room, community kitchen, or sports equipment rental



**COMPACT I SQUARE**

- Approximately 50 occupants
- Approximately 3,000 square feet
- No multipurpose room, community kitchen, or sports equipment rental



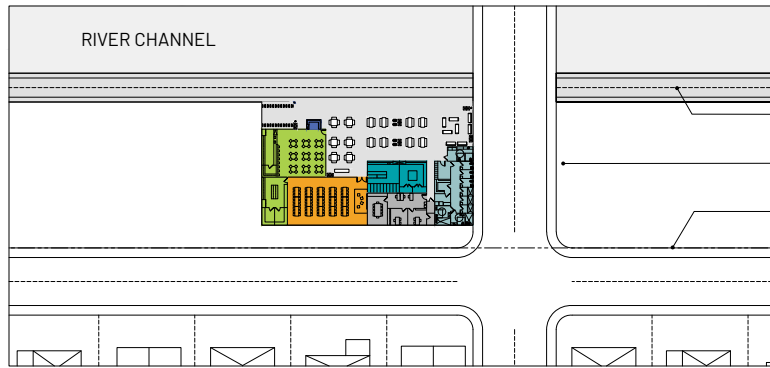
**COMPACT I LINEAR**

- Approximately 50 occupants
- Approximately 3,000 square feet
- No multipurpose room, community kitchen, or sports equipment rental



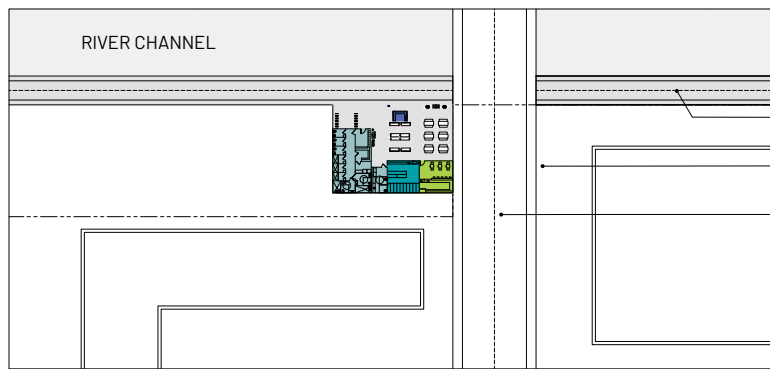
Figure 321. The Gathering Pavilion (Tier III) can be configured in a variety of footprints from compact to expanded, depending on the project site and other constraints.

MINIMUM



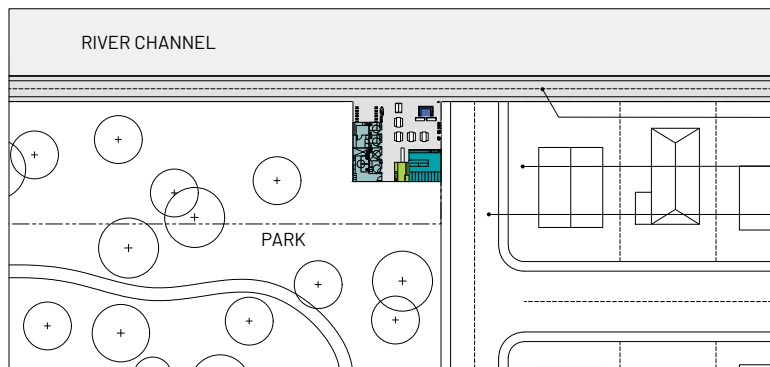
**EXPANDED**

- Across residential street



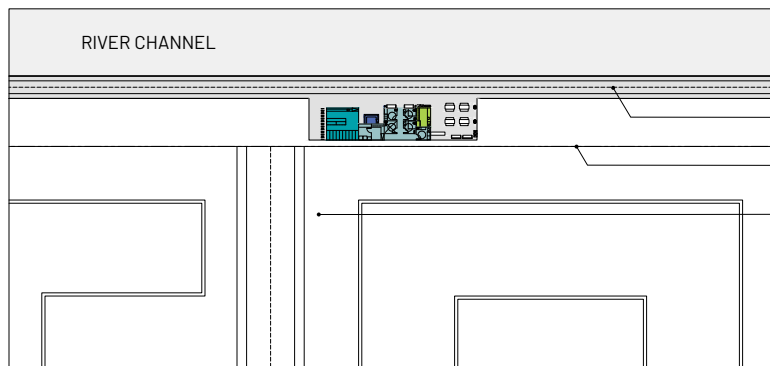
**MODERATE**

- Adjacent to commercial sites



**COMPACT | SQUARE**

- Within park, near housing



**COMPACT | LINEAR**

- Adjacent to industrial sites



Figure 322. These example plans show how the Gathering Pavilion (Tier III) can be implemented in a variety of urban contexts along the LA River.



**PAVILIONS SITUATED ALONG THE  
LA RIVER SHOULD IMPLEMENT VARYING  
BEST PRACTICES TO EMBODY THE SAME  
ENVIRONMENTAL, PUBLIC HEALTH,  
AND SOCIAL VISION OF THE LA RIVER  
MASTER PLAN OVERALL**

---

## **PAVILION BEST PRACTICES**

The development of River Pavilions should incorporate water, environmental, construction, and social best practices, among many others. When developing River Pavilions, there are numerous prevailing standards for best practices to reference, including but not limited to California's Title 24 Part 6 Building Energy Efficient Standards, United States Green Building Council's (USGBC) Leadership in Energy and Environmental Design (LEED), United States Department of Energy Better Buildings Initiative, Energy Star, Dark Sky, Cradle-to-Cradle, and Green Globes, among many others. Pavilions should also reference future standards and best practices for upcoming development.

All pavilions should promote the health, safety, and welfare of river users. First, all pavilions should optimize lighting at night, to enhance visibility, deter criminal behaviors, and lessen concerns of safety. However, lighting should not be too bright as to cause significant light pollution or create oppressive environments. Emergency call boxes should sit near the entry of all pavilions and create a recognizable and regular network of public safety mechanisms. Rest (Tier I) and Gathering (Tier II) Pavilions in particular should provide first-aid kits and automatic

defibrillators for emergencies great and small. Self-administered first-aid kits in particular require regular inspection, maintenance, and replenishment with single-use medications. Lastly, Gathering Pavilions (Tier III) incorporate public safety stations that can have on-site staff, river staff, and/or police officers to serve and support river users. The presence of public safety and police officers will further help to strengthen notions of safety along the river and serve visitors during moments of need. However, it is critical to not oversurveil river users, as to make them feel uncomfortable in their occupation of the river and its facilities and amenities.

River Pavilions offer refuge to river users and river-adjacent communities and should reflect the same aspiration of enhancing visitors' experience of the river as the LA River Master Plan at large. Pavilions should not result in demanding energy and water usage, cause environmental nuisances, engage unsustainable building practices, nor create inaccessible facilities and amenities. Pavilions should serve as an example of varying best practices and help propel the LA River into a future of access, equity, and resiliency.





### **WATER**

- Follow LA County LID Standards
- On-site water retention, detention, and filtration
- Capture 100% of on-site rainfall for the 85% rain event
- Greywater and rainwater reuse
- Low-flow water fixtures



### **ENERGY AND ENVIRONMENT**

- Utilize renewable energy sources (solar, wind, and water)
- Optimize building orientation for solar exposure, diffused daylight, and passive ventilation
- High thermal performance
- Energy efficient appliances
- Pollution reduction



### **MATERIALITY**

- Locally sourced and recyclable materials with low embodied energy
- Recycled and reused materials
- High-albedo roof and paving materials to mitigate heat gain
- Green roof and permeable paving



### **CONSTRUCTION / O&M**

- Recycle construction waste
- Reduce dust and mitigate other nuisances during construction
- Green cleaning and integrated building management
- Regularly monitor building systems and optimize usage



### **SOCIAL**

- Provide universal access to all communities and users
- Avoid physical deterrents
- Provide spaces for socialization
- Promote public engagement with areas for large gatherings

# COMMON ELEMENTS: SITE FURNISHINGS

Successful projects, trails, and connected public open spaces require a series of common elements ranging from consistent lighting to drinking fountains to places to sit along the LA River. Common elements include the site furnishings described on the following pages. These furnishings will contribute to the habitability of the river environs, promote safety, and build a cohesive identity. While river pavilions and large project designs are encouraged to use bespoke elements along the river, a common set of site furnishings with unified colors and amenities used across all sites and trails will promote equity, identity, legibility, and accessibility. Site furnishings offer opportunities for integration of public art and to celebrate local cultures. Sustainable building practices such as material reuse is encouraged in the common elements along the LA River, subject to the suitability and review of contaminants that may be in the materials and that could impact water quality.



## RAL CODES FOR SITE FURNISHINGS



**RAL 9007 GREY**



**RAL 5013 (PANTONE 282 C) BLUE**

Figure 323. LA River Site Furnishings should use RAL 9007 for silver metallic finishes and an RAL 5013 to match the environmental graphics and for overall consistency along the LA River.

- 1 **LITTER & RECYCLING**  
SEE PAGE 358
- 2 **BIKE RACK**  
SEE PAGE 359
- 3 **BENCHES**  
SEE PAGE 360

- 4 **DRINKING FOUNTAIN**  
SEE PAGE 361
- 5 **LIGHTING**  
SEE PAGE 362

- 6 **EMERGENCY CALL BOX**  
SEE PAGE 365
- 7 **RECREATION**  
SEE PAGE 366



Figure 324. A variety of site furnishings can be placed at pavilions, parks, or along the river trail. See the following pages for more details on each element.

# SITE FURNISHINGS: LITTER AND RECYCLING RECEPTACLES

Litter and recycling receptacles are necessary to maintain the health, safety, and the general aesthetic of the LA River.

Litter Receptacles along the LA River must meet the following guidelines:

## Aesthetics

- Select receptacles without ornament or protrusions.
- Receptacles should be metal with a solid metallic gray color finish matching RAL 9007 or comparable equal.
- Receptacles should have rain guards or a side opening that prevents rainwater from collecting in the receptacle.

## Assembly, Installation, and Manufacturer

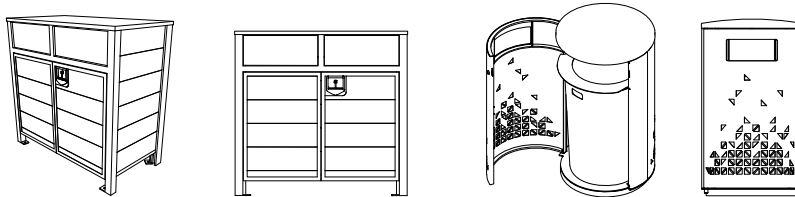
- Locate receptacles so that they are easily accessible from the trail or other user area.
- Locate receptacles at entrances, rest stops, major access points, and near benches.
- Co-locate recycling receptacles adjacent to all trash receptacles.

## Maintenance

- Install receptacles that are easy to empty and do not require heavy lifting by maintenance staff. For example, seek receptacles with side panels that open to empty.
- Coordinate maintenance program to ensure receptacles will be emptied regularly.
- Ensure receptacle does not leach or contaminate adjacent areas.

## RECEPTACLE FORMS: BEST PRACTICE

ACCEPTABLE FORMS



UNACCEPTABLE FORMS

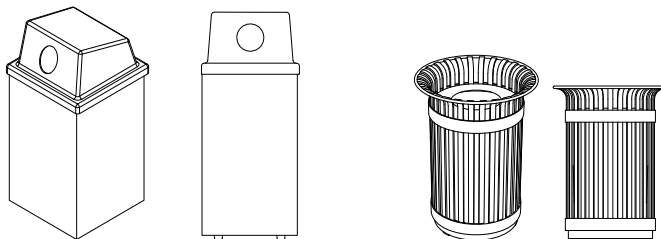


Figure 325. Litter receptacles should have simple forms with flat tops and an opening protected from rain.

# SITE FURNISHINGS: BIKE RACKS

Frequent bicycle racks encourage the use of bicycle trails and multi-modal transit along the LA River and throughout LA County.

Bicycle racks along the LA River must meet the following guidelines:

## Aesthetics

- Select racks without ornament or protrusions.
- Racks should be metal with a solid metallic gray color finish matching RAL 9007 or comparable equal.
- Provide racks with individual loops, not continuous rows.

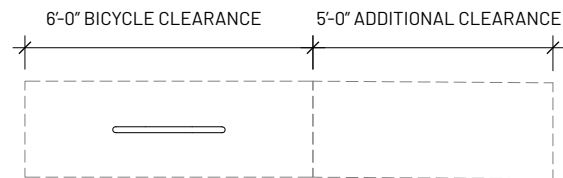
## Installation, Assembly, and Manufacturer

- Provide 6 feet of length for bikes and an additional 5-foot unobstructed clearance for bike parking.
- Locate racks at entrances to the river, pavilions, and access points.

## Maintenance

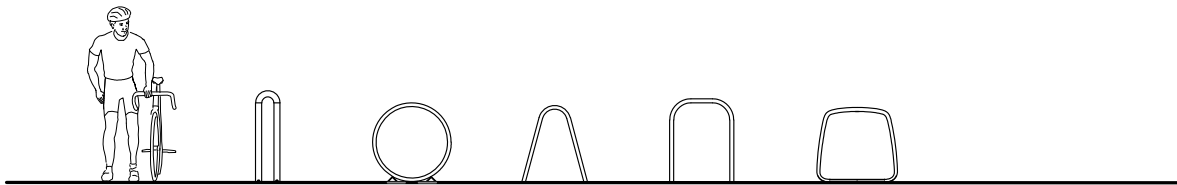
- Use a durable material that will withstand weathering.
- Maintain bicycle racks, deter graffiti where possible, and inspect for other damages.

### BICYCLE RACK PLAN



### BICYCLE RACK FORMS: BEST PRACTICE

ACCEPTABLE FORMS



UNACCEPTABLE FORMS

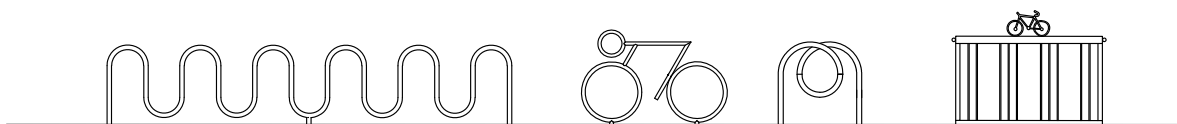


Figure 326. (Top) Bicycle racks should be placed to allow room for parking and maneuvering.  
 Figure 327. (Bottom) Bicycle racks should be individual loops and simple forms without ornamentation.



# SITE FURNISHINGS: BENCHES

Seating along the LA River provides respite along trails and other facilities.

Benches may offer opportunities for integrating art and community expression. Benches and other features intended to be artistic elements are approved through the arts approval process and do not necessarily need to meet these guidelines.

Benches and seating along the LA River must meet the following guidelines:

## Aesthetics

Coordinate bench and seating design with overall design approach. Seating elements are good locations for art and community expression.

Typical best practices:

- Ensure bench sitting surface is not metal. For metal supports or other elements, utilize satin or matte finish solid metallic gray matching RAL 9007 or comparable equal.

- Provide flexibility for various sitting options.
- Provide a variety of seating elements in addition to benches, such as seatwalls, seatsteps, and rock outcroppings.
- Group benches to promote social interaction.

## Installation, Assembly, and Manufacturer

- Locate benches so that they are easily accessible from the trail.
- Locate benches at trail intersections and special views.
- Where freestanding benches are used, provide anchorages to adjacent pavement and engineer appropriate footings.

## Maintenance

- Maintain benches, deter graffiti where possible, and inspect for other damages.

## BENCH FORMS: BEST PRACTICE

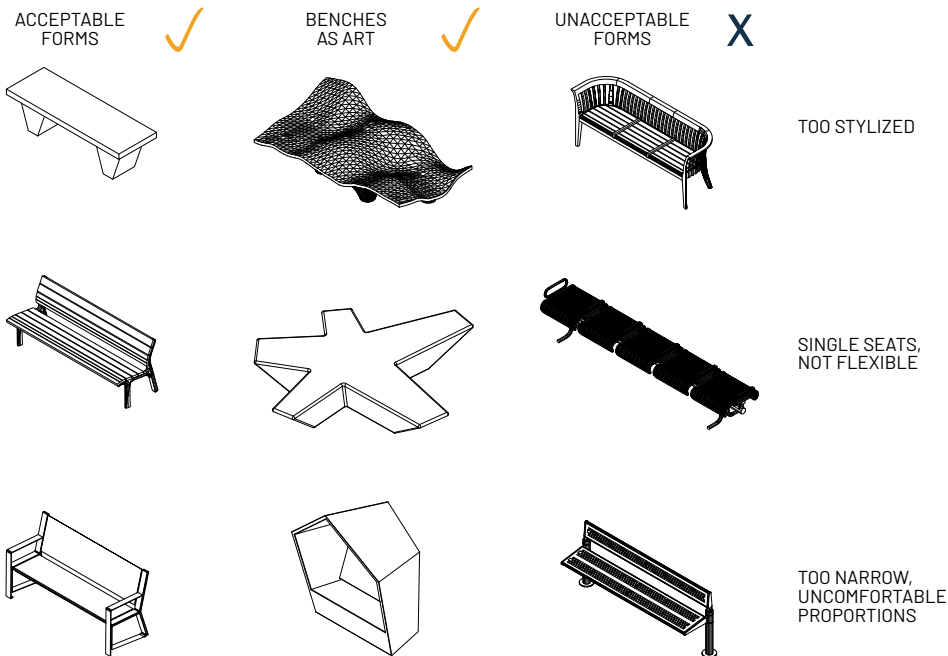


Figure 328. Bench forms should prioritize users' comfort and provide flexibility in use.

# SITE FURNISHINGS: DRINKING FOUNTAINS

Drinking fountains are crucial to users of the LA River Trail, especially on hotter-than-average summer days. They promote hydration and personal health along the river corridor.

Drinking fountains along the LA River must meet the following guidelines:

## Aesthetics

- Drinking fountains should be metal with a solid metallic gray color finish matching RAL 9007 or comparable equal.
- Include bottle filling station.
- Include pet drinking feature underneath.

## Installation, Assembly, and Manufacturer

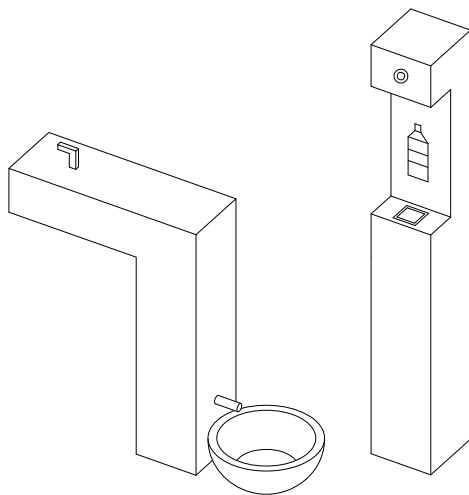
- Locate at major gathering spaces and at regular intervals along the multiuse trail.
- Locate drinking fountains so that they are easily accessible from the trail.

## Maintenance

- Maintain water fountains, deter graffiti where possible, and inspect for other damages.

## FOUNTAINS FORMS: BEST PRACTICE

ACCEPTABLE FORMS



UNACCEPTABLE FORMS

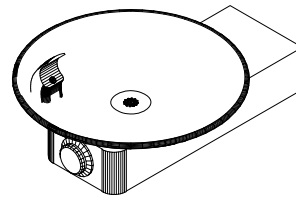


Figure 329. Drinking fountains should not have cupping or bowl shapes for hygiene and ease of cleaning.

# SITE FURNISHINGS: LIGHTING

Lighting provides visibility for cyclists and pedestrians and highlights special areas such as major access points, emergency call boxes, and information kiosks. Trail underpasses, future overpasses, and street ends are all areas that need special attention to lighting with regards to safety and visibility. All lighting should minimize light pollution to the greatest extent possible and be sensitive to ecological needs. Special care needs to be taken around wildlife habitat areas. Project lighting should be designed by qualified lighting design professionals. Technology and research with regards to lighting is constantly evolving, and the most efficient fixtures should be allowed for use in projects along the LA River.

Lighting elements along the LA River vary per specific application. Overall, all lighting must meet the following requirements.

## Aesthetics

- Select fixtures that have a modern, urban aesthetic free of extraneous decorative elements.
- Acorn light fixtures and light masts are prohibited.
- Integrate lighting into architecture where possible rather than having standalone fixtures.
- Finish for luminaries and pole must be available in a neutral solid metallic gray color matching RAL 9007 or comparable equal.

## Light Quality and Locations

- Complete lighting study to determine appropriate light levels, fixture types, and fixture heights.
- Install lighting at over/underpasses, intersections, and trailheads for safety.
- Use LED or more efficient light source.

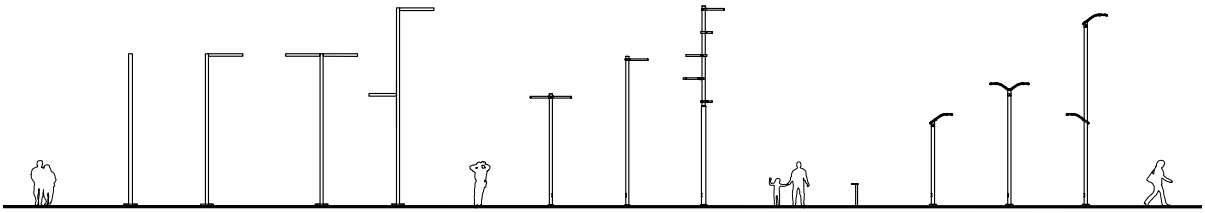
- Use Dark Sky compliant and BUG rated (backlight, uplight, glare) fixtures. These ratings should be as efficient as possible and eliminate spillover lighting. Fixtures should meet these requirements without adding additional shielding.
- Provide fixtures that have IES (Illuminating Engineering Society) files for illumination measured in lumens (bulb strength depending on pole height) and footcandles (light falling on a surface determined by lighting designer).
- Engineer poles and footings to withstand all project loads, including but not limited to, wind loads.
- Luminaire housing to be IP66 suitable for damp locations.

## Installation, Assembly, and Manufacturer

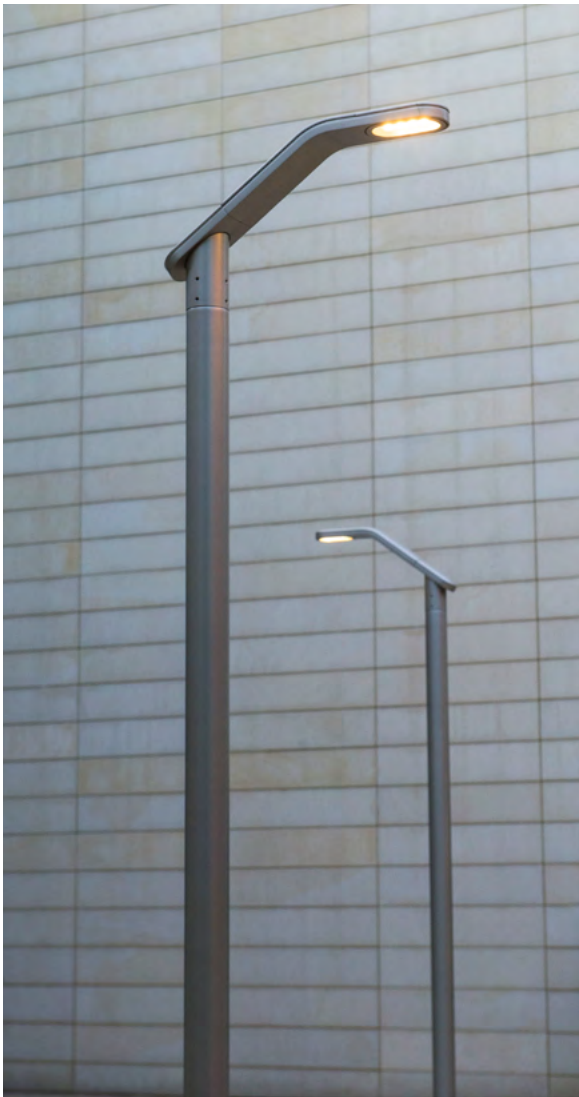
- Require UL listed products.
- Require manufacturers with established history of light fixture production.
- Snap together assembly or comparable system for ease of installation.
- Use fixtures that can host other uses including emergency call boxes, banners, and signs.
- Use products supported with complete engineering drawings and patents.

## Energy Use and Maintenance

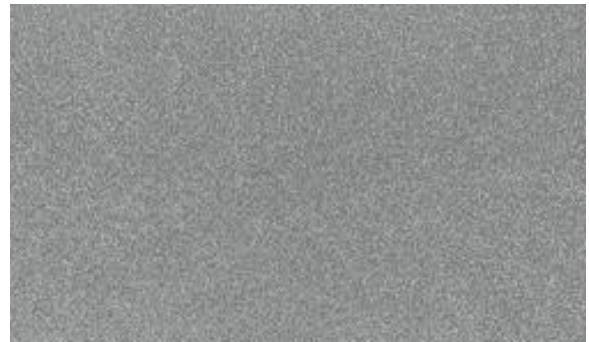
- Use fixtures made with recycled content where possible.
- Ensure fixtures have LED cartridges that are easily replaced.



**LA RIVER EXAMPLES LIGHTING FAMILIES**



**EXAMPLE LUMINAIRE**



**RAL 9007 GREY**



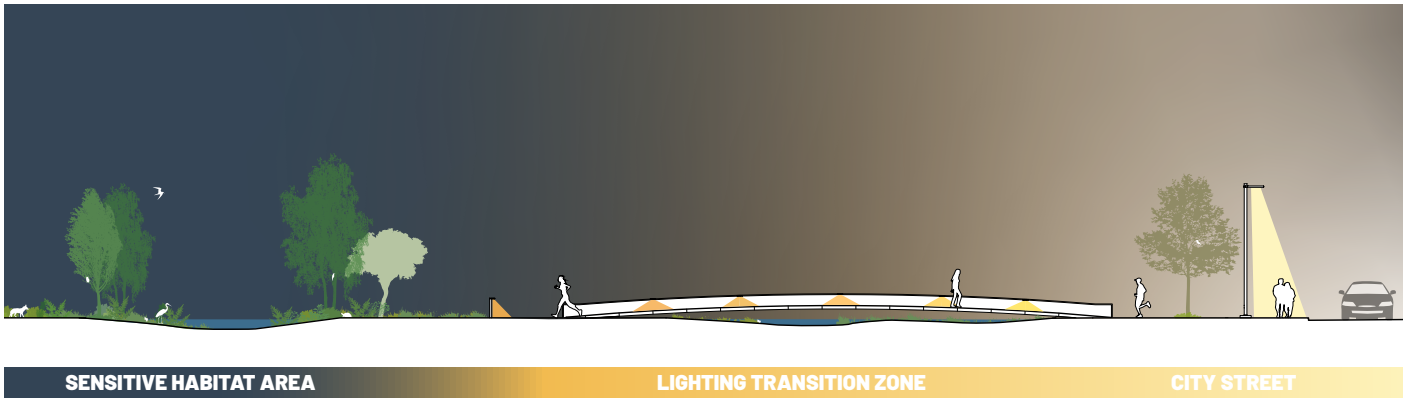
**EXAMPLE LUMINAIRE**

Figure 330. (Top) Luminaires should have a modern, simple form without ornamentation.

Figure 331. (Left) Luminaires should be Dark Sky compliant and not have protruding features. Source: Torres Area Light, Landscape Forms, 2017.

Figure 332. (Top Right) All finishes should be a solid metallic grey color matching RAL 9007. Source: RAL-Color 9007, Wikimedia Commons, 2007.

Figure 333. (Bottom Right) Luminaires should occur at a regular cadence to illuminate the path. Source: Rama Area Light, Landscape Forms, 2008.



**Figure 334.** Factors such as light color temperature should step down incrementally when transitioning from street lighting to sensitive habitat areas that are not lit. Qualified lighting designers, landscape architects, and ecologists should work to limit the amount of light fixtures, reduce color temperature, and eliminate light spillover on a project by project basis.

Lighting for trails or paths of egress along the LA River must meet the following:

- Use only what fixtures are needed, and the warmest color temperature possible to provide safety and egress. Do not over-light or make lights unnecessarily bright.
- Provide fixtures and controls capable of dimming or shutting off lighting when occupancy loads are low (example: dimmable driver and occupancy sensor).
- Color rendering should be at least 80 CRI.
- Avoid light bollards where possible.

Lighting for wildlife habitat areas must meet the following:

- Use as few fixtures as possible. Fixtures should be low-level lighting. Avoid tall poles where possible.
- Use the warmest color temperature possible, no more than 2200K as a maximum. Consider other measures that impact wildlife when selecting an appropriate fixture, such as the light spectrum emitted.
- Transition to a warm color temperature in gradual steps if moving from a street or path of egress to a habitat area.
- Provide fixtures and controls capable of shutting off lighting on a timer, such as when a park is closed, to limit the duration of lighting to the absolute minimum period possible.
- No CRI level is required. Light should be as amber as possible.

Sample fixtures that may meet requirements include Landscape Forms RAMA, Landscape Forms Torres, and Hess Linea. BEGA also carries low-level lighting fixtures that may meet requirements for lighting wildlife habitat areas.



# SITE FURNISHINGS: EMERGENCY CALL BOXES

Emergency call boxes are crucial to the perceived and actual safety of users along the LA River. They are important in case a user does not own or have access to a cell phone and because they allow emergency response to pinpoint the exact location of a caller.

Emergency call boxes along the LA River must meet the following:

## Aesthetics

- Select product with an identifying light or beacon on top. There should be no protrusions or ornamentation.
- Provide accessible push-button calling.
- Along trail, call box should be directional towards the trail. In an open area with many angles of approach, the call box should be non-directional.

## Installation, Assembly, and Manufacturer

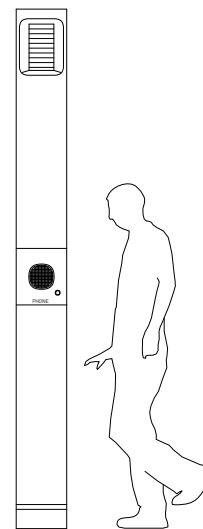
- Locate call boxes along bike path every 1/2 mile minimum, to be coordinated with river pavilion locations. They should be clearly visible from the trail.
- Ensure that the call box is TTY (text telephone for the deaf) equipped.
- Provide on-site programming option and option to program up to two emergency phone numbers.
- Functioning temperature range should withstand extreme heat (up to 150 °F).
- Cellular or hard lined to be determined by presiding agency.

## Energy Use and Maintenance

- Use solar powered call boxes along the river wherever possible.
- Maintain call boxes, deter graffiti where possible, and inspect for continued functionality and other damages.



**CALL BOX LIGHT BEACON**



**CALL BOX ELEVATION**

**Figure 335. (Left) Call boxes should have an identifiable and visible top. When possible, call boxes should match the LARMP Blue, RAL 5013.**

Source: Blue Light Tower, CASE Emergency systems, 2019.

**Figure 336. (Middle) Call boxes should be freestanding tall structures with push button calling.** Source: Blue Light Tower, CASE Emergency systems, 2019.

# SITE FURNISHINGS: RECREATION

Common elements can include areas of play and recreation for children of all ages and abilities along the LA River. For such areas, consider partnering with nearby schools or after-school programs to provide regular programming and a consistent presence in the space. Educational programs and environmental graphics can also be included. Recreation areas can be an opportunity to incorporate art and community expression in custom pieces.

The design for recreation should be for children of all abilities and predispositions. Include quiet areas for rest and reflection in addition to wide-open, high activity areas. Incorporate natural play elements and materials where and when possible to foster a connection to the ecosystems of the LA River while installing materials that will not compromise water quality. Water play elements are also encouraged where responsible water use methods are followed. Play and interactive water feature consultants can also ensure that proper spacing, fall areas, layout, and equipment follow prevailing codes.

When designing a recreation area, the following criteria should be considered:

## Aesthetics

- Ensure that recreation areas are accessible and allow for various types of passive and active play.
- Recreation areas should be shaded by trees and have adjacent vegetated areas. Incorporate natural materials such as logs, stumps, grassy mounds, and boulders where possible.
- Off-the-shelf play structures should generally use natural materials where possible. If metal elements are used, utilize satin or matte finish solid metallic gray matching RAL 9007 or comparable equal. Ensure that metal or other synthetic materials do not have compounds that leach and compromise water quality. Also ensure that they are shaded or will not overheat in direct sunlight.

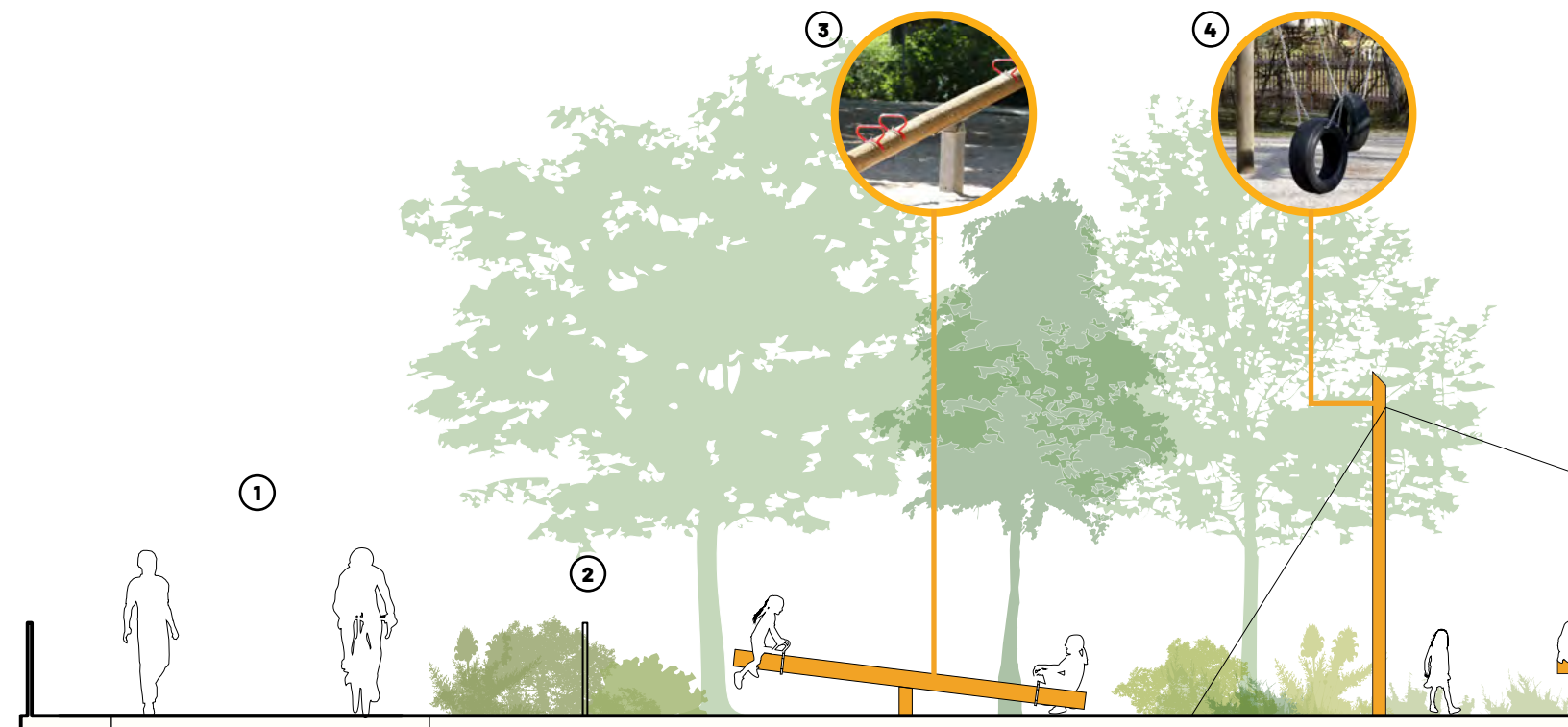


Figure 337. (Left) See-saws are an example of an active play structure.

Figure 338. (Right) Swing sets come in many materials and forms that can be used in a play area, including tire swings. Source: [https://pxhere.com/en/photo/653563?utm\\_content=shareClip&utm\\_medium=referral&utm\\_source=pxhere](https://pxhere.com/en/photo/653563?utm_content=shareClip&utm_medium=referral&utm_source=pxhere).

### Installation, Assembly, and Manufacturer

- Add seating and benches where space allows so that parents, teachers, or other guardians can supervise play.
- Ensure that any play equipment is assembled per manufacturer’s recommendations.
- Consult experts as needed to ensure all required fall areas and prevailing codes are met.

### Maintenance

- Maintain recreation area, deter graffiti where possible, and inspect for other damages.
- Coordinate maintenance program to ensure that materials and play equipment will be replaced as required by wear and tear.

- 1 LA RIVER MULTIUSE TRAIL SEE CH 3
- 2 VEGETATED BUFFER + FENCING SEE CH 3
- 3 ACTIVE GROUP PLAY STRUCTURE EXAMPLE
- 4 ACTIVE INDIVIDUAL PLAY STRUCTURE EXAMPLE
- 5 PLAY SURFACING EXAMPLE
- 6 BENCHES SEE PAGE 360
- 7 PASSIVE NATURE PLAY AREA EXAMPLE
- 8 DRINKING FOUNTAIN SEE PAGE 361



Figure 339. (Left) Play surfacing should meet fall requirements of prevailing codes while not leaching materials that negatively impact water quality. Source: <https://www.pxfuel.com/en/free-photo-xzrxa>.

Figure 340. (Right) Tree stumps and other passive play equipment can create areas for quiet, non-active play. Source: rikkerst, 2009. <https://pixabay.com/photos/tree-stumps-tree-slices-v-66915/>.

# FACILITIES AND AMENITIES CHECKLIST

Reference the LACFCD and Public Works Permitting checklist on page 36 for an overview of project permitting and applicable codes.

## Detailed Technical Requirements Checklist for Facilities and Amenities

### Occupancy

- Shade Pavilions (Tier I) must be sized for the following approximate occupancy rates:
  - Compact | Linear (27' x 9'): 5 occupants
  - Compact | Square (15' x 15'): 5 occupants
  - Moderate (30' x 20'): 10 occupants
  - Expanded (35' x 25'): 20 occupants
- Rest Pavilions (Tier II) must be sized for the following approximate occupancy rates:
  - Compact | Linear (77' x 13'): 20 occupants
  - Compact | Square (30' x 30'): 20 occupants
  - Moderate (45' x 40'): 30 occupants
  - Expanded (60' x 50'): 50 occupants
- Gathering Pavilions (Tier III) must be sized for the following approximate occupancy rates:
  - Compact | Linear (105' x 26'): 50 occupants
  - Compact | Square (55' x 50'): 50 occupants
  - Moderate (75' x 55'): 100 occupants
  - Expanded (132' x 77'): 500 occupants

### River Pavilions

- Follow applicable building codes: Federal, state, and county requirements, such as California's Title 24 Part 6 Building Energy Efficiency Standards, and local building codes, zoning regulations, and parking requirements.
- Shade Pavilions (Tier I) must include:
  - Shade structure or mature canopy trees and seating
  - River education display
  - Drinking fountain
  - Emergency call box
  - Litter and recycling receptacles
  - Pet waste station

- Rest Pavilions (Tier II) must include everything in the Shade Pavilions (Tier I) plus the following:
  - Single occupancy restrooms / basic sanitation facilities
  - Charging station
  - Bike racks (number based on occupancy and local codes)
  - Snack station
  - Picnic tables
- Gather Pavilions (Tier III) must include everything in the Shade Pavilions (Tier I) and Rest Pavilions (Tier II) plus the following:
  - Locker rooms / enhanced sanitation facilities
  - Public safety station
  - Cafe

#### **Common Elements**

- All projects must provide:
  - Benches and seating (to follow requirements on page 360)
  - Bike racks (to follow requirements on page 359)
  - Litter and recycling receptacles (to follow requirements on page 358)
  - Drinking fountains (to follow requirements on page 361)
  - Lighting (to follow requirements on page 362)
  - Emergency call boxes (to follow requirements on page 365)
  - Use graffiti-deterrent finishes where possible.

#### **Detailed Maintenance Program Checklist for Facilities and Amenities**

##### **River Pavilions**

- Develop a pavilion-specific maintenance plan and schedule - frequent and special attention is required to prevent vandalism and ensure proper use of facilities.
- For Rest (Tier II) and Gathering (Tier III) Pavilions, dedicated full-time staff is required.

##### **Common Elements**

- Coordinate with presiding agency for lighting, trash and litter receptacles, and emergency call boxes.
- Inspect furnishings regularly for damages and continued functionality.





UPDATE ROUND 1: WHAT WE HEARD

SOBRE LA PARTICIPACION DE LOS ASISTENTES EN LA 1ª RONDA: LO QUE

# ENGAGED IN MEETINGS & SURVEY

Community members attended the Canoga Park meeting  
Miembros de la comunidad asistieron a la reunión de Canoga Park

Community members attended the Cudahy meeting  
Miembros de la comunidad asistieron a la reunión de Cudahy

Community members attended the Long Beach meeting  
Miembros de la comunidad asistieron a la reunión de Long Beach

Community members attended the Friendship Auditorium meeting  
Miembros de la comunidad asistieron a la reunión de Friendship Auditorium

Community members attended the Studio City meeting  
Miembros de la comunidad asistieron a la reunión de Studio City.

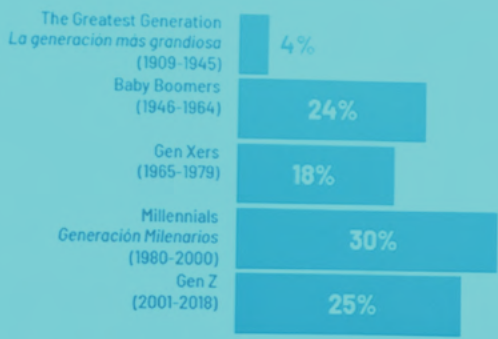
Completed digital and In-person surveys as of Jan 29, 2019  
Cuestionarios completados digitalmente y en persona hasta el 29 de enero, 2019.

Completed youth summit surveys  
Cuestionarios completados por los jóvenes

## MÁS DE 1,550 PERSONAS ASISTIERON A LAS REUNIONES COMUNITARIAS & COMPLETARON LA ENCUESTA

GENERATIONS REPRESENTED  
GENERACIONES REPRESENTADAS:

(Total from Survey + Community Meetings + Youth Summit)  
(Total de Encuesta + Reuniones Comunitarias + Cumbre Juvenil)



**PUBLIC HEALTH**  
LA COUNTY ADULT HEALTH SURVEY  
DESCRIPCIÓN DE ADULTOS DEL CONDADO DE LOS ANGELES

36%	24%
24%	10%
\$258	

SINCE 2007, LA COUNTY ADULTS  
DE THE COUNTY ADULTS ALL COUNTY  
LOS ANGELES

59%	1
-----	---

Figure 341. Attendees listening to the Jessica Henson speak about the Master Plan at the Canoga Park community meeting at river mile 51. Source: OLIN, 2018.



# RESOURCES

# GLOSSARY

**1% Flood (100-Year Flood):** A flood of a magnitude that has a 1 percent chance of being equaled or exceeded in any given year (i.e., has a recurrence interval of 100 years, on average).

**1% Floodplain (100-Year Floodplain):** Areas with a 1 percent annual chance of flooding.

**0.2% Flood (500-Year Flood):** A flood of a magnitude that has a 0.2 percent chance of being equaled or exceeded in any given year (i.e., has a recurrence interval of 500 years, on average).

**0.2% Floodplain (500-Year Floodplain):** Areas with a 0.2 percent annual chance of flooding.

**Active Transport:** Modes of transportation that are non-motorized relying on physical activity, such as walking and cycling, in addition to public transportation, which will be understood to require walking or cycling as a part of the whole journey. (Source: Healthy Spaces & Places, Australia)

**Alluvium/Alluvial:** Any soil or rock material deposit transported by water.

**Aquifer:** A natural underground layer of porous, water bearing materials (sand, gravel) usually capable of yielding a large amount or supply of water.

**Aquifer Recharge:** Aquifer recharge (AR) and aquifer storage and recovery (ASR) are processes that convey water underground. These processes replenish groundwater stored in aquifers for beneficial purposes. Although the terms are often used interchangeably, they are separate processes with distinct objectives. AR is used solely to replenish water in aquifers. ASR is used to store water which is later recovered for reuse. (Source: USEPA)

**Area Median Income:** The median family income calculated by the US Department of Housing and Urban Development (HUD) for each jurisdiction, in order to determine Fair Market Rents (FMRs) and income limits for HUD programs. Also known as HUD Area Median Family Income.

**Aspect:** The compass direction of exposure of a site to environmental factors (in particular, sunlight).

**Beneficial Use:** **1.** The uses of water necessary for the survival or well being of man, plants and wildlife. These uses of water serve to promote the tangible and intangible economic, social and environmental goals of mankind. Examples include drinking, swimming, industrial and agricultural water supply, and the support of fresh and saline aquatic habitats. **2.** Defines the resources, services, and qualities of aquatic systems that are the ultimate goals of protecting and achieving. For example, Beneficial Use of Estuarine Habitat are uses of water that support estuarine ecosystems, including, but not limited to, preservation or enhancement of estuarine habitats, vegetation, fish, shellfish, or wildlife (e.g., estuarine mammals, waterfowl, shorebirds), and the propagation, sustenance, and migration of estuarine organisms. (Source: Regional Water Board, Heal the Bay)

**Best Management Practice (BMP):** In the context of water quality, BMPs are structural, non-structural devices and/or managerial techniques that improve or prevent the pollution contained within dry and wet weather runoff from reaching downstream water ways.

**Climate Adapted Trees:** Tree species that are able to tolerate a range of current and projected future temperature and moisture conditions typical of the location in which they are planted. This includes increases in heat and drought as projected by future climate change models and increased temperature and smog caused by the urban heat island effects within urban contexts.

**Box Channel:** A rectangular-shaped section of a channel, typically made of concrete.

**Canopy:** The uppermost continuous layer of foliage in forest vegetation formed by the crowns of the trees.

**Climate Resourcefulness:** An approach to climate resilience and justice that frames resilience in community action and/or activism as well as community self-determination and agency. This framework proposed a re-centering and re-grounding of resilience in communities and progressive, justice movements. (Source: Mackinnon and Derickson, 2013. "From Resilience to Resourcefulness: A Critique of Resilience Policy and Activism." Progress in Human Geography, 37.)

**Community Based Process:** Varies among communities and project scope but generally includes the following steps: initial community consultation; gathering data, observations, and analysis of primary issues; sharing those issues back to the community for further input; and finally, implementation. (Source: Project for Public Spaces)

**Confined Aquifer:** An aquifer in which an impermeable layer of soil or rock lays on top and prevents water from seeping into the ground.

**Distributed Infiltration:** Naturally or artificially allowing rainwater and runoff to percolate into the soil on a widespread basis.



**Disturbance:** Environmental fluctuations and destructive events, both man-made as well as natural, whether or not these are perceived as 'normal' for a particular system.

**Diversity:** Full range of variety and variability within and among living organisms, their associations, and habitat-oriented ecological complexes. Term encompasses ecosystem, species, and landscape as well as intraspecific (genetic) levels of diversity.

**Ecoregions:** Areas where ecosystems (and the type, quality, and quantity of environmental resources) are generally similar. This framework is derived from mapping done in collaboration with USEPA regional offices, other Federal agencies, state resource management agencies, and neighboring North American countries. (Source: USEPA)

**Ecosystem Function:** The biological, geochemical and physical processes that take place or occur within an ecosystem. These processes often benefit human needs directly or indirectly. For example: providing shade, carbon sequestration, or filtering pollutants.

**Ecosystem Services:** The direct or indirect contributions of ecosystems to human well-being that support our survival and quality of life.

**Ecotone:** A transition area, or region, of vegetation between two different biological communities (biomes).

**Embankment (Levee):** An often manmade primarily earthen barrier along a watercourse with the principle function of containing, managing, or diverting the flow of water in to reduce risk from temporary flooding.

**Extant Vegetation:** The mix of plants and trees present aboveground in a vegetated area that still exists from pre-urbanization conditions.

**Fenceline:** A boundary line created by a fence or other linear element.

**Fence:** A barrier for public safety along LA County watercourses at least 60 inches high off the adjacent surface. Designers should reference the latest LA County codes for any updates.

**Flood Control Basin:** Large, empty basins which hold significant amounts of water during flood conditions to reduce flooding downstream. Examples of flood control basins in LA County include Sepulveda and Hansen.

**Flood Channel:** Concrete or earthen channels that convey water during large rain events. Flood channels are sometimes built on the courses of waterways as a way to reduce flooding. The LA River and many of its tributaries operate as flood channels.

**Flood Control District:** The Los Angeles County Flood Control Act (ACT) was adopted by the State Legislature in 1915, after a disastrous regional flood took a heavy toll on lives and property. The Act established the Los Angeles County Flood Control District and empowered it to provide flood protection, water conservation, recreation and aesthetic enhancement within its boundaries. The Flood Control District is governed, as a separate entity, by the County of Los Angeles Board of Supervisors.

**Forest:** An area of closely canopied trees.

**Fuel break:** A gap, strip, or block of vegetation in which detritus and debris have been removed, and which has been altered to act as a barrier to slow or stop the progress of a wildfire. They are also known as fire breaks, which are more commonly strips or areas of bare soil or fire-retardant material.

**Functioning Ecosystem:** A dynamic complex of plant, animal, and microorganism communities and their non-living environment that exhibits biological and chemical activities characteristic for its type, regardless of whether the system visually looks like a natural system.

**Gate:** An aperture along a fence to provide access while maintaining public safety.

**Groundwater Basin:** Groundwater stored in an area with permeable materials below the ground, typically capable of storing a significant supply of water.

**Guardrail:** A barrier at least 42 inches high near the open sides of elevated surfaces that minimizes the possibility of a fall. Guardrails should follow the latest code and ADA requirements (such as restrictions on openings).

**Habitat:** The locality, site, and particular type of local environment occupied by an organism; includes food, water, shelter, cover, and the ability to raise young.

**Habitat Linkage:** A connection between large areas of habitat that is typically vegetated. Linkages are critical to provide sufficient habitat for wide-ranging animal species with large home territories as well as for other wildlife species.

**Historic Floodplain:** Areas subject to inundation by the LA River and its tributaries and distributaries prior significant channelization in the 19th and 20th centuries.

**Horizontal Structure:** Patchiness; the composition and distribution of species that varies widely from one spot to the next.

**Hydraulic Reach:** A reach is a length of stream or river used as a unit of study. It contains a specified feature that is either fairly uniform throughout, such as hydraulic characteristics or flood damages, or that requires special attention in the study, such as a bridge. (Source: USDA)

**Hydraulics:** Science that focuses on the movement of water through channels, pipes, and rivers.

**Hydrology:** The study of water, specifically its properties, movement and interaction with land, and how it affects the earth and atmosphere.

**Indeterminate Growth:** Growth that continues throughout the lifespan of an individual.

**Infiltration:** The gradual flow or movement of water into and through (to percolate or pass through) the pores of the soil.

**Injection:** An injection well is a device that places fluid deep underground into porous rock formations, such as sandstone or limestone, or into or below the shallow soil layer.

**Invasive Species:** An alien species whose introduction does or is likely to cause economic or environmental harm or harm to human health. (Source: USDA)

**Invasive Non-Native Plant Species:** Plant species that are both non-native and able to establish on many sites, grow quickly, and spread to the point of disrupting plant communities or ecosystems, causing environmental harm and/or harm to human health. (Source: USDA)

**LA River ROW:** The LA River right-of-way is the “fenceline to fenceline” area of the river channel and typically includes the river, river banks or levees, and LA River Trail. The ROW is owned and maintained by a variety of entities.

**Landside (Levee):** The area from the edge of the crown to the toe of the levee opposite of the riverside.

**LA River Watershed Native Plant Species:** Plant species that are a part of the balance of nature that has developed over hundreds or thousands of years in the LA River Watershed. Refer to the LA River Design Guidelines plant community lists, qualified botanists or ecologists, and resources such as the California Native Plant Society (<https://www.cnps.org/>). (Source: USDA)

**Levee:** An embankment whose primary purpose is to furnish flood protection from seasonal high water and which is therefore subject to water loading for periods of only a few days or weeks a year.

**Local Park:** Local parks are under 100 acres and contain active amenities such as athletic courts and fields, playgrounds, and swimming pools. (Source: LA County Parks and Recreation)

**Local Tribal Government:** Refers to three local Tribal nations that identify themselves as Ventureño, Fernandeño, or Gabrieleno. This list can be obtained from the Nativer American Heritage Commission of California.

**Low Flow Channel:** In a concrete flood control channel, the low flow channel is a narrow, lowered section within the middle of the channel, designed to concentrate steady, non-wet weather runoff (water treatment flows, irrigation, etc.) by increasing channel velocity and depth.

**Low Impact Development (LID):** A term used to describe a land planning and engineering design approach to manage stormwater runoff as part of green infrastructure. LID emphasizes conservation and use of on-site natural features to protect water quality.

**Mafic:** Pertaining to rocks rich in magnesium and iron.

**Multiuse Trail:** Trails which allow for many user types, such as pedestrians, cyclists, and equestrians.

**Mycorrhizae:** Largely symbiotic relationships between large and taxonomically diverse groups of fungi and vascular plants that allows for the uptake of water and minerals by the vascular plant, and for the uptake of sugars and carbohydrates from the vascular plant by the associated fungus.

**Native Species:** A species that is a part of the balance of nature that has developed over hundreds or thousands of years in a particular region or ecosystem. (Source: USDA)

**Nature-based:** Nature-based strategies aim to protect, manage, and enhance natural or modified ecosystems through sustainable techniques that produce benefits for society and biodiversity. (Source: International Union for Conservation of Nature)

**Non Native Plant Species:** A plant species introduced with human help (intentionally or accidentally) to a new place or new type of habitat where it was not previously found. Not all non-native plants are invasive and may not reproduce or spread readily without continued human help. (Source: USDA)

**Perched Aquifer:** Localized zone of saturation above the main water table created by a laterally limited layer of underlying impermeable material.



**Perennials:** Plants that persist for several years with a period of growth each year.

**Planning Frame:** A series of nine geographical areas used in the LA River Master Plan to assist in the delineation of reach-specific concepts related to jurisdictional, hydraulic, and ecological zones. The planning frames also offer a more detailed local scale to assess project cadence, character, and community connectivity along the varying conditions of the LA River.

**Platform Park:** A park situated on a structural deck spanning over a space typically unsuitable for parkland, such as a roadway or waterbody.

**Potable Water:** Water quality that is suitable for drinking.

**Propagule:** Any part of an organism, produced sexually or asexually, that is capable of giving rise to a new individual. (For plants: seeds, cuttings, divisions, etc.)

**Public Art:** The creative community expression which includes permanent and temporary installations, cultural facilities and uses, and community engagement and programming. Other examples include, but are not limited to: sculpture, murals, portable paintings, fixtures, exhibit or performance space, conservation, performing arts, literary art, media art, new media, education, special events, arts services, community engagement, food, building arts, and environmental arts. (Source: LA County Department of Arts and Culture)

**Railing:** A barrier that separates trail uses or provides a visual separation but is not required to follow code.

**Receiving Waters:** All distinct bodies of water that receive runoff or wastewater discharges, such as streams, rivers, ponds, lakes, and estuaries.

**Recharge:** Process of addition of water to the saturated zone such as an aquifer. (Source: USGS)

**Recharge Area:** An area in which water reached the zone of saturation by surface infiltration. (Source: USGS)

**Reclaimed Wastewater:** Wastewater-treatment plant effluent that has been diverted for beneficial uses such as irrigation, industry, or thermoelectric cooling instead of being released to a natural waterway or aquifer. (Source: USGS)

**Regional Detention (Basin):** A detention basin which collects stormwater runoff from a relatively large area, and has been designed to use storage as a means of reducing downstream flood peaks, reducing possible flood damage, or reducing downstream channel construction costs. Regional facilities are usually multi-purpose, and normally are the responsibility of a public entity. (Source: Pima County Regional Flood Control District)

**Regional Park:** Park over 100 acres and contains active amenities such as athletic courts and fields, playgrounds, and swimming pools. (Source: LA County Parks and Recreation)

**Resiliency:** The capacity of individuals, communities, institutions, businesses, and systems within a city to survive, adapt, and grow, no matter what kinds of chronic stresses and acute shocks they experience. (Source: 100 Resilient Cities)

**Restoration:** Altering an area in such a way as to reestablish an ecosystem's structure and function, usually bringing it back to its original (pre-disturbance) state or to a healthy state close to the original. Management techniques that attempt to enhance or bring back the natural pre disturbance form and functions of a self-sustaining community or ecosystem; measures taken to return a site to pre-disturbance conditions.

**Revegetate:** Establish vegetation on disturbed lands.

**Rhizomatous:** Having an underground horizontal stem that bears reduced scaly leaves.

**Right-of-way:** An easement granted or reserved over the land for transportation or other public service infrastructure such as electrical transmission lines or flood control channels. The LA River right-of-way includes the entirety of the river channel as well as the landside areas immediately adjacent to the channel banks that facilitate continuous operations and maintenance access by the LA County Public Works (on behalf of the Flood Control District) and the United States Army Corps of Engineers (USACE).

**Riparian:** Pertaining to the banks of a stream, most often used to describe the hydrophilic (water-loving) vegetation along a stream.

**River Mile:** A measure of distance along the river centerline from its mouth. The LA River river mile system was developed in 2016 to reduce confusion between different jurisdictional reach designations. This numbering system is used consistently throughout the LA River Master Plan, with mile 0 at the river mouth in Long Beach and mile 51 in Canoga Park.

**River Ruler:** The river ruler is an analysis tool developed for the LA River Master Plan that represents and takes measure of the entire 51 miles of the LA River in a simple vertical straight-line diagram. This approach simplifies and reinforces the river's linearity, allowing the eye to quickly perceive how conditions along the river change from one river mile to the next. This compact abstraction of the river allows for comparing across multiple river ruler categories at multiple locations along the river in a single drawing and is essential for recognizing where planning and design proposals can achieve multiple benefits at a particular location.

**Senescence:** The biological process of aging.

**Solarizing:** Weed management technique whereby sunlight is used to kill weed seed in the soil by using either transparent or black plastic to capture radiant heat energy from the sun, thereby causing physical, chemical, and biological changes in the soil. Solarization reduces populations of weeds, disease-causing organisms, harmful invertebrates, and insect pests in the top 3-6 inches of soil without environmental contamination; and increases populations of warmth loving beneficial soil organisms.

**Spreading Basin:** Basin used to impound water to allow for slow percolation of water into the ground to recharge the underlying groundwater aquifer.

**Spreading Grounds:** A spreading ground is a water conservation facility that retains surface water long enough for it to percolate into the soil where it can be stored and pumped for later use. Spreading grounds must be located within soft bottom channels or adjacent to rivers and flood channels and situated where underlying soils are permeable and in hydraulic connection to a target aquifer.

**Stormwater:** Stormwater runoff is generated from rain and snowmelt events that flow over land or impervious surfaces, such as paved streets, parking lots, and building rooftops, and does not soak into the ground. The runoff picks up pollutants like trash, chemicals, oils, and dirt/sediment that can harm our rivers, streams, lakes, and coastal waters. (Source: USEPA)

**Succession:** The geological, ecological or seasonal sequence of species within a habitat or community.

**Trapezoidal Section:** A section of a channel with a trapezoidal cross-section. This shape is used to efficiently convey flows on a concrete surface.

**Tributary:** A stream that flows to a larger stream or other body of water.

**Unconfined Aquifer:** A water table—or unconfined—aquifer is an aquifer whose upper water surface (water table) is at atmospheric pressure, and thus is able to rise and fall. Water table aquifers are usually closer to the Earth's surface than confined aquifers are, and as such are impacted by drought conditions sooner than confined aquifers. (Source: USGS)

**Understory:** The vegetation layer between the overstory or canopy and the groundlayer of a forest or woodland community.

**Upland:** Referring to locations elevated above lower-lying locations, often used when discussing two locations within a watershed.

**US Army Corps of Engineers:** The Army Corps of Engineers provides public engineering services in peace and war to strengthen national security, energize the economy, and reduce risks from disasters.

**Vegetation:** The assemblage of plant species in a given area; also used as a general term for plant life.

**Vertical Structure:** Division of vegetation into distinct layers, each adapted to increasingly filtered sunlight if going top down. The layers are: canopy, understory, groundlayer, and the forest (or woodland) floor. Not all forests and woodlands have each layer.

**Water Quality:** Surface water conditions suitable for aquatic life and human health.

**Water Security:** The capacity of a population to safeguard sustainable access to adequate quantities of acceptable quality water for sustaining livelihoods, human well-being, and socioeconomic development, for ensuring protection against water-borne pollution and water-related disasters, and for preserving ecosystems in a climate of peace and political stability. (Source: United Nations Water)

**Water Supply:** Available water provided to fulfill a particular need. If the need is domestic, industrial, or agricultural, the water must fulfill both quality and quantity requirements. Water supplies can be obtained by numerous types of engineering projects, such as wells, dams, or reservoirs. (Source: Encyclopaedia Britannica)

**Water Year:** The 12-month period from October 1 through September 30 for any given year. Water years are written as the ending year (i.e., water year 1986-87 is written as 1987).

**Watershed:** The land area that drains into a river or stream. An area of land that contributes runoff to one specific delivery point. Large watersheds may be composed of several smaller "sub watersheds," each of which contributes runoff to different locations that ultimately combine at a common delivery point. Watersheds are usually bordered and separated from other watersheds by mountain ridges or other naturally elevated areas.

**Wetland:** Any number of tidal and non-tidal areas characterized by saturated or nearly saturated (wet) soils most of the year that form an interface between terrestrial (land-based) and aquatic environments. These include freshwater marshes around ponds and channels (rivers and streams) and brackish and salt marshes. Other common names include swamps and bogs.

**Woodland:** An area of canopied trees with greater distances between trees than found in forested areas.

# RESOURCE LIST

LA County does not endorse any of these suppliers or guarantee that they meet the necessary requirements placed on them from the Master Plan or other applicable documents.

## NATIVE PLANT NURSERIES

### A & F

Formerly Mockingbird Nursery, wholesale nursery for shrubs, ornamental grasses, trees, succulents, and annuals.

—  
803 Adams Street, Riverside, CA 92504-5310  
951.352.4922  
<https://afgrowers.com>  
[office@afgrowers.com](mailto:office@afgrowers.com)

### Antelope Valley Resource Conservation Nursery

Commercial nursery with capacity for contract growing and educational programs.

—  
10148 West Avenue I, Lancaster, CA 93536  
661.942.7306  
<https://www.avrcd.org>  
[avrcd@carcd.org](mailto:avrcd@carcd.org)

### Artemisia Nursery

Small retail nursery more appropriate for small scale projects.

—  
5068 Valley Blvd., Los Angeles, CA 90032  
323.795.5515  
<https://www.artemisianursery.com>  
[artemisianursery@gmail.com](mailto:artemisianursery@gmail.com)

### Back to Natives Nursery @ Santiago Park

Prefer to use seeds collected from or near the site. Right now the BTN Nursery is entirely volunteer driven though the scale of projects seem to range from small to large restoration projects.

—  
Santiago Park Nature Reserve, Santa Ana, CA 92706  
949.509.4787  
<http://www.backtonatives.org/nursery>  
[info@backtonatives.org](mailto:info@backtonatives.org)

### California Botanic Garden

Working with Seed LA initiative (contact Naomi Fraga; [nfraga@calbg.org](mailto:nfraga@calbg.org)) for native seed sourcing. Medium sized retail nursery with capacity for contract grows for restoration and mitigation projects.

—  
1500 N College Avenue, Claremont, CA 91711  
909.625.8767  
[www.rsabg.org](http://www.rsabg.org)  
[gnnclaremont@rsabg.org](mailto:gnnclaremont@rsabg.org); [bsale@rsabg.org](mailto:bsale@rsabg.org)

### California Native Plant Nurseries

Updated list of active native plant nurseries maintained by the California Native Plant Society.

—  
<https://calscape.org/nurseries.php>

### El Nativo Growers

Large wholesale nursery supplying a range of small to large projects including restoration.

—  
200 South Peckham Road, Azusa, CA 91702  
626.969.8449  
[www.elnativogrowers.com](http://www.elnativogrowers.com)  
[sales@elnativogrowers.com](mailto:sales@elnativogrowers.com)

### Fremontia Horticultural Inc.

Specializing in drought tolerant plants for large scale projects including succulents and grasses.

—  
0401 E Riverside Drive, Ontario, CA 91761  
909.673.0600  
<https://fremontiahorticultural.com>  
[info@fremontiahorticultural.com](mailto:info@fremontiahorticultural.com)

### Glendora Gardens

Medium sized nursery with drought tolerant species as well as sod, soil, and turf removal services.

—  
1132 S. Grand Avenue, Glendora, CA 91740  
626.914.6718  
<https://www.glendoragardens.com>

**Greenbelt Growers**

Specializing in ornamental plants for commercial landscape and restoration projects.

—  
9820 Dufferin Avenue, Riverside, CA 92503  
951.688.4091  
<https://www.greenbeltgrowers.com/>  
[sales@greenbeltgrowers.com](mailto:sales@greenbeltgrowers.com)

**Hahamongna Native Plant Nursery**

Contact Arroyo Seco Foundation for details.

—  
Hahamongna Watershed Park, 4550 Oak Grove Drive, Pasadena, CA 91103  
323.405.7326

**Las Pilitas Nursery**

Large wholesale nursery specializing in large projects.

—  
3232 Las Pilitas Road, Santa Margarita, CA 93453  
805.438.5992  
[www.laspilitas.com](http://www.laspilitas.com)  
[penny@laspilitas.com](mailto:penny@laspilitas.com)

**Matilija Nursery**

Large wholesale nursery with climate suitable varieties of groundcovers, shrubs, trees, perennials, and grasses specializing in large projects including contract grows for restoration.

—  
8225 Waters Road, Moorpark, CA 93021  
805.523.8604  
[www.matilijanursery.com](http://www.matilijanursery.com)  
[matilijanurserweb@gmail.com](mailto:matilijanurserweb@gmail.com)

**Moosa Creek**

Wholesale nursery and contract grower that also supplies plants to retail nurseries and garden centers as listed on their website.

—  
27201 Cool Water Ranch Road, Valley Center, CA 760.749.3216  
[http:// www.moosacreeknursery.com](http://www.moosacreeknursery.com)  
[nursery@moosacreek.com](mailto:nursery@moosacreek.com)

**Native West Nursery, Inc.**

Formerly Recon Native Plants, wholesale and retail nursery with contract growing.

—  
1755 Saturn Boulevard, San Diego, CA 92154  
619.423.2284  
<https://nativewest.com>  
[info@nativewest.com](mailto:info@nativewest.com)

**Pacific Coast Nursery, Inc.**

Large wholesale nursery specializing in large commercial development projects.

—  
1924 Monroe Street, Riverside, CA 92504  
951.689.1777  
<https://www.pacificcoastnursery.com>  
[info@pacificcoastnursery.com](mailto:info@pacificcoastnursery.com)

**Tarweed Native Plants**

Small retail nursery more appropriate for small scale projects.

—  
1307 Graynold Avenue, Glendale, CA 91202  
818.419.7034  
<http://www.tarweednativeplants.com/>  
[tarweed@tarweednativeplants.com](mailto:tarweed@tarweednativeplants.com)

**Theodore Payne Foundation**

Large retail nursery with a focus on native seed sourcing and propagation.

—  
10459 Tuxford Street, Sun Valley, CA 91711  
818.768.1802  
[www.theodorepayne.org](http://www.theodorepayne.org)  
[info@theodorepayne.org](mailto:info@theodorepayne.org)

**Tree of Life Nursery**

Wholesale/retail nursery with capacity for contract growing, an active mycorrhizae program, and local seed mix availability.

—  
33201 Ortega Highway, San Juan Capistrano, CA 92693  
949.728.0685  
[www.californianativeplants.com](http://www.californianativeplants.com)  
[inquiries@treeoflifenuresery.com](mailto:inquiries@treeoflifenuresery.com)

LA County does not endorse any of these suppliers or guarantee that they meet the necessary requirements placed on them from the Master Plan or other applicable documents.

## **NATIVE PLANT SEED**

### **California Botanic Garden**

Nursery and regional educational resource.

—

1500 North College Avenue, Claremont, CA 91711  
909.625.8767  
www.calbg.org  
info@calbg.org

### **Larner Seeds**

Specializes in California native seeds and homeowner restoration projects.

—

235 Grove Road, Bolinas, CA 94924  
415.868.9407  
<https://www.larnerseeds.com/>  
info@larnerseeds.com

### **S & S Seeds**

Extensive seed inventory and mixes available for sale.

—

P.O. Box 1275, Carpinteria, CA 93014  
805.684.0436  
<http://www.ssseeds.com>  
info@ssseeds.com

### **Seed LA**

New nonprofit working with California Botanic Garden among other nurseries to encourage native seed use.

—

www.seedla.org  
(contact Naomi Fraga; nfraga@calbg.org)

### **Stover Seed Company**

Native and non-native seed company with a native seed database for large scale projects.

—

P.O. Box 1579, Sun Valley, CA 91353  
800.621.0315  
www.stoverseed.com  
customer\_service@stoverseed.com

### **Theodore Payne Foundation**

Nursery and regional educational resource.

—

10459 Tuxford Street Sun Valley, CA 91711  
818.768.1802  
www.theodorepayne.org  
info@theodorepayne.org



# ENDNOTES

- 1 Historic Resources Surveys. Los Angeles City Planning . Accessed March 24, 2020. <https://planning.lacity.org/preservation-design/historic-resources-survey>.
- 2 Los Angeles River Master Plan, Los Angeles County Public Works, 1996
- 3 LA County Flood Control District, Guidance for Flood Control Permits. <http://dpw.lacounty.gov/idd/lib/forms/Guidelines/LACFCD%20Flood%20Permit%20Guidance%20v4.2.1.pdf>
- 4 Ibid.
- 5 Ibid.
- 6 Ibid.
- 7 Ibid.
- 8 U.S. Environmental Protection Agency, "Permit Program under CWA Section 404." April 30, 2019. <https://www.epa.gov/cwa-404/permit-program-under-cwa-section-404>
- 9 Headquarters U.S. Army Corps of Engineers, "Section 408." April 30, 2019. <https://www.usace.army.mil/Missions/Civil-Works/Section408/>
- 10 State Water Resources Control Board, 401 Water Quality Certification Frequently Asked Questions. May 2014. [https://www.waterboards.ca.gov/sandiego/water\\_issues/programs/401\\_certification/docs/401c/401FAQRB9V514.pdf](https://www.waterboards.ca.gov/sandiego/water_issues/programs/401_certification/docs/401c/401FAQRB9V514.pdf)
- 11 Ibid.
- 12 Headquarters U.S. Army Corps of Engineers, "Section 408." April 30, 2019. <https://www.usace.army.mil/Missions/Civil-Works/Section408/>
- 13 Ibid.
- 14 State Water Resources Control Board, 401 Water Quality Certification Frequently Asked Questions. May 2014. [https://www.waterboards.ca.gov/sandiego/water\\_issues/programs/401\\_certification/docs/401c/401FAQRB9V514.pdf](https://www.waterboards.ca.gov/sandiego/water_issues/programs/401_certification/docs/401c/401FAQRB9V514.pdf)
- 15 Headquarters U.S. Army Corps of Engineers, "Section 408." April 30, 2019. <https://www.usace.army.mil/Missions/Civil-Works/Section408/>
- 16 U.S. Department of Justice. (2010). 2010 ADA Standards for Accessible Design. Washington, DC: U.S. Department of Justice.
- 17 Rallo, A., Forest, E., Kuo, J., Boutilier, R., & Li, E. (2019). Access Ability 2: A Practical Handbook on Accessible Graphic Design (2nd ed.). Toronto, ON: The Association of Registered Graphic Designers (RGD).
- 18 California State Parks, State of California. "General Provisions." CA State Parks, 2019. [https://www.parks.ca.gov/?page\\_id=21301](https://www.parks.ca.gov/?page_id=21301).
- 19 United States of America, Department of the Army, US Army Corps of Engineers, Guidelines for Landscape Planting and Vegetation Management at Levees, Floodwalls, Embankment Dams, and Appurtenant Structures, ETL 1110-2-583 (Washington, D.C.: US Army Corps of Engineers, 2014), 3-3.
- 20 United States of America, Department of the Army, US Army Corps of Engineers, Guidelines for Landscape Planting and Vegetation Management at Levees, Floodwalls, Embankment Dams, and Appurtenant Structures, ETL 1110-2-583 (Washington, D.C.: US Army Corps of Engineers, 2014), 2-2.
- 21 United States of America. County of Los Angeles Public Works. Low Impact Development Standards Manual. Los Angeles, CA, 2014.
- 22 University of California. "The Urban Agriculture Incentive Zones Act (AB551)." Urban Agriculture, n.d. [https://ucanr.edu/sites/UrbanAg/Laws\\_Zoning\\_and\\_Regulations/The\\_Urban\\_Agriculture\\_Incentive\\_Zones\\_Act\\_AB551/](https://ucanr.edu/sites/UrbanAg/Laws_Zoning_and_Regulations/The_Urban_Agriculture_Incentive_Zones_Act_AB551/). Accessed 08/27/19.
- 23 Trust for Public Land, Los Angeles County Public Works, and City of South Gate. "Agreement with the Trust for Public Land for the Urban Orchard Project" (2017). p. 26.
- 24 Los Angeles County Development Authority, and Carmelitos Public Housing Development. "The Growing Experience: An Urban Farm." Community Garden, n.d. <https://growingexperienceb.lacda.org/community-garden>. Accessed 08/27/19.
- 25 Garcia, Richard D. "Alma Backyard Farms," n.d. <https://www.almabackyardfarms.com/>. Accessed 08/27/19.
- 26 Wood, Jason, and Emily Gleicher. Farm LA , n.d. <http://farmla.org/>.
- 27 State of California. "Model Water Efficient Landscape Ordinance." California Department of Water Resources , 2015. <https://water.ca.gov/Programs/Water-Use-And-Efficiency/Urban-Water-Use-Efficiency/Model-Water-Efficient-Landscape-Ordinance>. Accessed 08/27/19.
- 28 Brenzel, Kathleen Norris., ed. The New Sunset Western Garden Book: The Ultimate Gardening Guide. 9th ed. New York, NY: Time Home Entertainment Inc., 2012. p. 93-94, 698-706.

- 29 County of Los Angeles Public Works. Low Impact Development Standards Manual. Los Angeles, CA, 2014.
- 30 Bell, Carl and Dean Lehman. 2015. Best Management Practices for Vegetation Management (revised). Ellen Mackey, editor. Los Angeles County Weed Management Area. Los Angeles, California.
- 31 Leonard J. Hopper, Landscape Architectural Graphic Standards (Hoboken, NJ: Wiley, 2007), 505-510.
- 32 Leonard J. Hopper, Landscape Architectural Graphic Standards (Hoboken, NJ: Wiley, 2007), 785-790.
- 33 The California Chaparral Institute, The California Chaparral Preservation Plan. The California Chaparral Institute, Escondido, 2010. [www.californiachaparral.org](http://www.californiachaparral.org).
- 34 Ibid.
- 35 Allen, Edith B., et al. "Chaparral Restoration." In Valuing Chaparral, 347-84. Springer International Publishing, 2018. [https://www.fs.fed.us/psw/publications/beyers/psw\\_2018\\_beyers001\\_allen.pdf](https://www.fs.fed.us/psw/publications/beyers/psw_2018_beyers001_allen.pdf).
- 36 Quinn, Ronald D., Sterling C. Keeley, and Marianne D. Wallace. "Fire." In Introduction to California Chaparral, 1st ed., 43-73. University of California Press, Berkeley, 2006.
- 37 Allen, Edith B., et al. "Chaparral Restoration." In Valuing Chaparral, 347-84. Springer International Publishing, 2018. [https://www.fs.fed.us/psw/publications/beyers/psw\\_2018\\_beyers001\\_allen.pdf](https://www.fs.fed.us/psw/publications/beyers/psw_2018_beyers001_allen.pdf).
- 38 Natural Resources Conservation Service. "Code 383: Fuel Break." In Conservation Practice Standard. National Resources Conservation Service, CA, 2007. [https://efotg.sc.egov.usda.gov/references/public/CO/CO383\\_Spec.pdf](https://efotg.sc.egov.usda.gov/references/public/CO/CO383_Spec.pdf)
- 39 Ibid.
- 40 Sunset. "Create a Landscape that Fights Fire." Sunset Publishing Corporation, CA, 2003. Cited in Topanga Coalition for Emergency Preparedness. <http://www.t-cep.org/wildfire/createalandscape.htm>
- 41 Natural Resources Conservation Service. "Code 383: Fuel Break." In Conservation Practice Standard. National Resources Conservation Service, CA, 2007. [https://efotg.sc.egov.usda.gov/references/public/CO/CO383\\_Spec.pdf](https://efotg.sc.egov.usda.gov/references/public/CO/CO383_Spec.pdf)
- 42 Bellm Carl and Dean Lehman. 2015. Best Management Practices for Vegetation Management (revised). Ellen Mackey, editor. Los Angeles County Weed Management Area. Los Angeles, California.

# BIBLIOGRAPHY

The Design Guidelines rely on a wealth of knowledge from the following sources.

- Abrams, LeRoy. *Flora of Los Angeles and Vicinity*. Stanford: Stanford University Press. First Edition. 1904.
- Abrams, LeRoy. *Flora of Los Angeles and Vicinity*. 2nd Edition. Stanford: Stanford University Press. 1917.
- Bakker, Elna. *An Island Called California: An Ecological Introduction to its Natural Communities*. Berkeley: University of California Press. 1971.
- Bell, Carl and Dean Lehman. 2015. *Best Management Practices for Vegetation Management (revised)*.
- Ellen Mackey, editor. *Los Angeles County Weed Management Area*. Los Angeles, California.
- Booth, Derek B. *The University of Washington Permeable Pavement Demonstration Project*. 1997.
- Booth, Derek ed. "Porous Asphalt Road Shoulders: Effect of Road Sanding Operations and Their Projected Life Span." *The Washington Water Resource*. Fall 1997.
- Brenzel, Kathleen Norris., ed. *The New Sunset Western Garden Book: The Ultimate Gardening Guide*. 9th ed. New York, NY: Time Home Entertainment Inc., 2012.
- Burrows, Colin J. *Processes of Vegetation Change*. Boston: Unwin Hyman Ltd. 1990.
- CA Native Plant database and search tool
- California Department of Conservation, Office of Mine Reclamation, Showers, Mary Ann and Karen Wiese. *Nursery Sources for California Native Plants DMG Open file Report 90-04*. 1995. (Revised from Newton, Gail and Laura Laidet. 1990, 1992.)
- California Department of Fish and Game, Barbour, Michael and Jeane Wirka. *Classification of Alluvial Scrub in Los Angeles, Riverside and San Bernardino Counties*. 1997. Unpublished report. (U.S. Fish and Wildlife Service, Section 6 program contract no. FG5638-RS)
- California Department of Fish and Game, Garrett, Kimball. *Biota of the Los Angeles River*. 1993. Unpublished report prepared by the Natural History Museum of Los Angeles County Foundation under contract no. FG 0541.
- California Department of Fish and Game, Holland, Robert F. *Preliminary Descriptions of the Terrestrial Natural Communities of California*. 1986. Unpublished report.
- California Native Plant Society, Los Angeles/Santa Monica Mountains Chapter. *Recommended List of Native Plants for Landscaping in the Santa Monica Mountains*. 1996.
- California Native Plant Society. Accessed May 2019. <https://calscape.org/>.
- California Native Plant Society. *Guidelines For Landscaping To Protect Native Vegetation From Genetic Degradation*. <http://www.cnps.org/archives/landscaping.htm>. December, 2001.
- California Resources Agency, San Gabriel and Lower Los Angeles Rivers and Mountains Conservancy and the Santa Monica Mountains Conservancy. *Common Ground from the Mountains to the Sea*.
- Watershed and Open Space Plan, San Gabriel and Los Angeles Rivers. October, 2001.
- California Stormwater Quality Association. *Stormwater Best Management Practice Handbooks; Construction; New Development & Redevelopment; Municipal; Industrial & Commercial*. 2003.
- Caltrans. *Bikeway Design Standards, Highway Design Manual*. February, 1995.
- City of Augusta, Georgia, County Planning Commission. *Riverfront Development Ordinance*. N.d.
- City of Los Angeles Planning Department and Department of Recreation and Parks. *Proposed Los Angeles River Greenbelt Corridor Feasibility Study*. December, 1990.
- City of Los Angeles, Department of City Planning. *Citywide Plan*. August, 1972.
- City of Los Angeles, Department of Recreation and Parks. *Landscape Architectural Design Standards*. August, 1995.
- City of Olympia, Public Works Department. *Impervious Surface Reduction Study*. January, 1996.
- City of San Antonio, Department of Planning. *Historic Preservation and Urban Design Ordinance # 80910*. December, 1994.
- City of Santa Cruz. *San Lorenzo River Design Concept Plan*. 1987.
- City of Santa Cruz. *San Lorenzo River Enhancement Plan*. n.d.
- City of Tempe. *Rio Salado A River Once More, Construction Update*. <http://www.tempe.gov/rio/>. October, 1998

Costello, L.R., et al. A Guide to Estimating Irrigation Water Needs of Landscape Plantings in California. UC Cooperative Extension, California Department of Water Resources, US Bureau of Reclamation. August 2000.

County of Los Angeles, Department of Arts and Culture, LA County Arts Report: Cultural Equity & Inclusion Initiative. April, 2017.

County of Los Angeles, Department of Public Works, Construction Division, Permit Section. Permit Guidelines. September, 1992.

County of Los Angeles, Department of Public Works. Los Angeles River Master Plan. June, 1996.

County of Los Angeles, Department of Public Works. Los Angeles River Master Plan Maintenance Guidelines. In preparation.

County of Los Angeles, Department of Public Works. Los Angeles River Master Plan Sign Guidelines. August, 2003.

County of Los Angeles, Department of Public Works. Low Impact Development Standards Manual. Los Angeles, CA, 2014.

County of Los Angeles, Department of Regional Planning. Plan of Bikeways. June, 1976.

County of Los Angeles, Flood Control District. Tujunga Wash Property Use Plan. 1981.

County of Los Angeles, Transportation Commission. Flood Control Channel Transportation Study, Phase I. October, 1989.

Crampton, Beecher. Grasses in California. Vol. 33 of California Natural History Guides. Berkeley and Los Angeles: University of California Press. 1974.

Czamanske, David. "Competing Bills Complicate Efforts to Create Conservancy." Arroyo View, June/July 1999, 6.

Dale, Nancy. Flowering Plants of the Santa Monica Mountains, Coastal and Chaparral Regions of Southern California. Santa Barbara: Capra Press. 1986.

Dallman, Suzanne and Thomas Piechota. Storm Water: Asset Not Liability. Los Angeles and San Gabriel Rivers Watershed Council. 1999.

East River Bikeway and Esplanade Planning and Design Project. "A River of Recreation." Landscape Architecture. November, 1996.

Friends of the Los Angeles River. Environmentally Compatible and Long-Term Flood Control Alternatives. 1993.

Glick, Fred. "Going Places." Landscape Architecture. March, 1985.

Good, James. "Effective Coastal Wetland Management." National Wetlands Newsletter. July/August, 1998.

Griffin, James R., and William B. Critchfield. The distribution of forest trees in California. Research Paper PSW-82. Berkeley, CA. Pacific Southwest Research Station, Berkeley, CA. U. S. Department of Agriculture Forest Service. 1976.

Hanes, T. L., R. D. Friesen, and K. Keane. "Alluvial scrub vegetation in coastal southern California." In California Riparian Systems Conference: Protection, management and restoration for the 1990s. September 22-24, 1988 in Davis, CA, edited by D. L. Abell, Pacific Southwest Forest and Range Experiment Station, U. S. Forest Service, USDA, 187-193. 1989.

Heintzman, James. Making the Right Connections: A Guide for Nature Writers. Stevens Point: UW-SP Foundation Press, Inc. 1988.

Hickman, James C., ed. The Jepson Manual: Higher Plants of California. Berkeley and Los Angeles: University of California Press. 1993.

Higgins, Lila M., Gregory B. Pauly, Jason G. Goldman, and Charles Hood. Wild LA: Explore the Amazing Nature in and around Los Angeles. Portland, OR: Timber Press, 2019.

Hopper, Leonard J. Landscape Architectural Graphic Standards. Hoboken, NJ: Wiley, 2007.

Jeavons, Jon. How to Grow More Vegetables: (and Fruits, Nuts, Berries, Grains, and Other Crops) Than You Ever Thought Possible on Less Land with Less Water Than You Can Imagine. Berkeley: Ten Speed Press. 2017.

Keeley, Jon E. "Demographic structure of California black walnut (*Juglans californica*: Juglandaceae) woodlands in California." Madrono. No. 4. 1990, 237-248.

Keeley, Jon E. "Native Grassland Restoration: The Initial Stage - Assessing Suitable Sites." Interface Between Ecology and Land Development in California. Los Angeles: Southern California Academy of Sciences. 1993.

Keeley, Jon E. "The California valley grassland." Endangered Plant Communities of Southern California. Proceedings of the 15th annual symposium, Southern California Botanists special publication No.3. Claremont: Rancho Santa Ana Botanic Garden. 1990.

Keller, Kit. Mountain Bikes on Public Lands: A Manager's Guide to the State of the Practice. Bicycle Federation of America. 1990.

King County, Washington. Surface Water Design Manual. February, 1996.

Kirkpatrick, J. B. and C. F. Hutchinson. "The community composition of Californian coastal sage scrub." Vegetation. 35 (1). 1977, 21-33.

Latané, Claire. Schools That Heal: Design with Mental Health in Mind. Washington, D.C.: Island Press. 2021.

Leccese, Michael. "A River Reborn." Landscape Architecture. June, 1996.

- Leccese, Michael. "In the San Antonio Mode." *Landscape Architecture*. November, 1996.
- Lenz, Lee W. and John Dourley. *California Native Trees and Shrubs: For Garden and Environmental Use in Southern California and Adjacent Areas*. Claremont: Rancho Santa Ana Botanic Garden. 1981.
- Leskinen, Carolyn Albee. "Juglans californica: Local patterns in southern California." M.A. thesis, University of California, Los Angeles. 1972.
- Los Angeles County Flood Control District, Chun, L. and L. Beauchaine. *Property Use Plan for Los Angeles River, Lankershim Boulevard to Sepulveda Boulevard*. February, 1982.
- Los Angeles County Flood Control District, Stone, H. W., L.L. Easton, et. al. *Aesthetic Standards Manual*. October, 1974.
- Marchand, M. and F. H. Toomstra. *Ecological Guidelines for River Basin Development*. March, 1986.
- Maynard, Michael. "On the Waterfront." *Landscape Architecture*. October, 1996.
- Mays, Vernon. "In the Boardwalk Tradition." *Landscape Architecture*. January, 1998.
- McAdam, Lewis. "Restoring the Los Angeles River: A Forty-Year Art Project." *Whole Earth Review*, Spring 1995, 62.
- Munz, P. A. and D. D. Keck. *A Flora of California and Supplement*. Berkeley and Los Angeles: University of California Press. 1968.
- O'Brien, Bart. "The Intersection of Conservation and Gardening: An Overview of the Consequences of Growing California Native Plants." *Fremontia* 29(1): 2001, 16-23.
- O'Brien, Bart, Betsey Landis, and Ellen Mackey. *Care & Maintenance of Southern California Native Plant Gardens = Cuidado Y Mantenimiento De Jardines De Plantas Nativas Del Sur De California*. Claremont, CA: Rancho Santa Ana Botanic Garden, 2006.
- O'Brien, Bart, Betsey Landis, and Ellen Mackey. *Gardener's Primer for Planting and Maintaining Native Plant Landscapes*. Published by Metropolitan Water District of Southern California. In preparation.
- O'Brien, Bart, Betsey Landis, and Ellen Mackey. *Care & Maintenance of Southern California Native Plant Gardens = Cuidado Y Mantenimiento De Jardines De Plantas Nativas Del Sur De California*. Claremont, CA: Rancho Santa Ana Botanic Garden, 2006.
- O'Leary, John. "California Coastal Sage Scrub: General Characteristics and Considerations for Biological Conservation." *Endangered Plant Communities of Southern California*. Proceedings of the 15th annual symposium, Southern California Botanists special publication No.3. Claremont: Rancho Santa Ana Botanic Garden. 1990.
- Perry, Bob. *Landscape Plants for California Gardens: An Illustrated Reference of Plants for California Landscapes*. Claremont, CA: Land Design Pub., 2010.
- Perry, Robert C. *Landscape Plants for Western Regions*. Claremont: Land Design Publishing. 1992.
- Quinn, Ronald D. "The Status of Walnut Forests and Woodlands (*Juglans californica*) in Southern California." *Endangered Plant Communities of Southern California*. Proceedings of the 15th annual symposium, Southern California Botanists special publication No. 3. Claremont: Rancho Santa Ana Botanic Garden. 1990.
- Quinn, Ronald D., and Sterling C. Keeley. *Introduction to California Chaparral*. Berkeley, CA: University of California Press, 2006.
- Rainer, Thomas, and Claudia West. *Planting in a Post-wild World: Designing Plant Communities for Resilient Landscapes*. Portland, OR: Timber Press, 2016.
- Raven, Peter H. et. al. *Flora of the Santa Monica Mountains*. 2nd Edition. Southern California Botanists Special Publication, No. 2. Los Angeles: University of California. 1986.
- Regnier, Kathleen, Michael Gross et. al. *The Interpreter's Guidebook*. Stevens Point: UW-SP Foundation Press, Inc. 1992.
- "Resources - For Communities - TreePeople's LA City Approved Street Tree List." TreePeople. November 27, 2018. Accessed May 2019. <https://www.treepeople.org/resources>.
- Roberts, Fred M. *Illustrated Guide to the Oaks of the Southern Californian Floristic Province: The Oaks of Coastal Southern California and Northwestern Baja California, Mexico*. Encinitas: F.M. Roberts Publications. 1995.
- Rosenthal, Sue and friends. "Native Plant Horticulture Resources: A Starting Point for Native Plant Gardening." *Fremontia* 29(1): 2001, 26-27.
- Sawyer, John O. and Todd Keeler-Wolf. *A Manual of California Vegetation*. Sacramento: California Native Plant Society. 1995.
- Smith, Robin Lee. "Alluvial scrub vegetation of the San Gabriel River Floodplain, California." *Madroño* 27(3): 1980, 126-138.



- Sprugel, D.G. "Disturbance, equilibrium, and environmental variability: What is 'natural' vegetation in a changing environment?" *Biological Conservation* 58: 1991, 1-18.
- St. John, Ted, and Bob Dixon. *Land Imprinting*. Tree of Life Nursery. March, 1996.
- St. John, Ted. *Habitat Restoration: A Regulator's Perspective*. Tree of Life Nursery. April, 1995.
- St. John, Ted. *Habitat Restoration: An Overview for Agency Clients*. Tree of Life Nursery. April, 1995.
- St. John, Ted. *Why Habitat Restoration Projects Fail*. Tree of Life Nursery. April, 1995.
- "Street Tree Selection Guide." City of Los Angeles Bureau of Street Services. Accessed May 2019. <http://bss.lacity.org/UrbanForestry/StreetTreeSelectionGuide.htm>.
- Stone, Edward and Associates. "River Redux." *Landscape Architecture*.
- Swanson, C. James, "The Ecology and Distribution of *Juglans californica* Wats. in Southern California." M. A. thesis California State College at Los Angeles. 1967.
- Swanson, Mitchell L., John Stanley, et. al. *San Lorenzo River Enhancement Plan*. n.d.
- Thompson, William. "A Creek Runs Through It." *Landscape Architecture*. February, 1996.
- Thompson, William. "Pier Review." *Landscape Architecture*. January, 1998.
- Trapp, Suzanne, Michael Gross et. al. *Signs, Trails, and Wayside Exhibits*. Stevens Point: UW-SP Foundation Press, Inc. 1992."
- "Tree of Life Nursery Native Plant Catalog." December 20, 2016. Accessed May 2019. <https://californianativeplants.com/plants/plantcatalogdownload/>.
- Trim, Heather. *Beneficial Uses of the Los Angeles and San Gabriel River*. Los Angeles and San Gabriel Rivers Watershed Council. 2001.
- United States Army Corps of Engineers. *Final Master Plan and Environmental Assessment-Los Angeles River Recreational Development*. March, 1998.
- United States Army Corps of Engineers. *Guidelines for Landscape Planting and Vegetation Management at Levees, Floodwalls, Embankment Dams, and Appurtenant Structures*. ETL 1110-2-583. Washington, D.C.: US Army Corps of Engineers, 2014.
- United States Army Corps of Engineers. *Landscape Planting at Floodwalls, Levees and Embankment Dams*. December 29, 1972.
- United States Army Corps of Engineers. *Los Angeles County Drainage Area Recreation Review*. September, 1988.
- United States Army Corps of Engineers. *Plants of the Los Angeles District*.
- United States Army Corps of Engineers. *Rio Salado, Salt River, Arizona, Feasibility Report*. April, 1998.
- United States Army Corps of Engineers, Los Angeles District Regulatory Branch. Michael Brandman Associates. *Preliminary draft biological assessment of threatened and endangered species: Los Angeles International Golf Club: Big Tujunga Wash, Los Angeles, CA*. 1988. Unpublished report.
- United States Department of Agriculture, Forest Service. *Sign and Poster Guidelines for the Forest Service*. August, 1998.
- United States Department of the Interior, National Park Service. *Comprehensive Management and Use Plan Final Environmental Impact Statement, Juan Bautista de Anza National Historic Trail, California, Arizona*. April, 1996.
- United States Department of the Interior, National Park Service. "Juan Bautista de Anza National Historic Trail, Official Map and Guide."
- United States Department of the Interior, National Park Service. *Wayside Exhibit Guidelines*. March, 1998.
- United States Engineer Office. *Flood Control in the Los Angeles County Drainage Area*. May, 1938.
- United States Forest Service (USFS). "Vegetation Types of California" (Corona, Cucamonga, Pomona, Redlands, San Bernardino, San Fernando and Santa Susanna quadrangles). 1:62,500 scales. Prepared under the direction of A. E. Weislander. 1932, 1934.
- Williams, Prentiss. "Los Angeles River Overflowing with Controversy." *California Coast & Ocean*. 8: Summer 1993.
- Wilson, Bert. "A Guide to the Plant Communities of California." Las Pilitas Native Plant Nursery. November 19, 2013. Accessed May 2019. <https://www.laspilitas.com/>.
- Wolf, Adam, Naupaka B. Zimmerman, William R. L. Anderegg, Posy E. Busby, and Jon Christensen. "Altitudinal Shifts of the Native and Introduced Flora of California in the Context of 20th-century Warming." *Global Ecology and Biogeography* 25, no. 4 (2016): 418-29. doi:10.1111/geb.12423.
- Zehr, Jeffrey, Michael Gross et. al. *Creating Environmental Publications*. Stevens Point: UW-SP Foundation Press, Inc. 1991.

# TABLE OF FIGURES

- Figure 1. The LA River begins at the confluence of Arroyo Calabasas and Bell Creek at river mile 51. Source: OLIN, 2018. Found on Page 10
- Figure 2. The LA River brings people and communities together in more ways than one, as can be seen in this photo of the SELA Arts Festival at river mile 11.7 in July 2018. Source: OLIN, 2018. Found on Page 12
- Figure 3. The LA River channel has two different profiles: box and trapezoid. This section of box channel runs through Studio City, near river mile 39. Source: OLIN, 2018. Found on Page 14
- Figure 4. Certain reaches of the LA River, such as this segment near river mile 25, are soft-bottom rather than concrete. Source: OLIN, 2018. Found on Page 16
- Figure 5. Certain reaches of the river, such as this segment at river mile 14, are entrenched rather than leveed. Source: OLIN, 2018. Found on Page 17
- Figure 6. Design strategies can be categorized into six infrastructure and urban river typologies. See Chapter 8 in the LA River Master Plan for more information. Source: LA River Master Plan, 2020. Found on Page 19
- Figure 7. The LA River Master Plan proposes five scales of impact for sites along the river: XS, S, M, L, XL. Each scale has varying needs for facilities, amenities, gathering spaces, performance areas, and recreation. Source: OLIN, 2018. Found on Page 20
- Figure 8. (Top) The LA River can host community performances, such as the one shown in the image by a local high school at the SELA Arts Festival at river mile 11.7. Source: OLIN, 2018. Found on Page 21
- Figure 9. (Middle) Local Artists, such as Leo Limon, utilize the LA River as a canvas. Source: Leo Limon, 2010. Found on Page 21
- Figure 10. (Bottom) The LA River is an important resource to the Indigenous Peoples of Los Angeles. This image shows the Native American Veterans Association's annual Veterans Appreciation and Heritage Pow Wow at river mile 13. Source: Marvin Lynchard, 2014. <https://www.flickr.com/photos/dodnewsfeatures/15691915659/in/photostream/>. Found on Page 21
- Figure 11. Projects along the LA River should improve ecosystem function and provide educational opportunities. Source: OLIN, 2019. Found on Page 23
- Figure 12. Vendors set up booths within the river channel at the SELA Arts Festival at river mile 11.7. Source: OLIN, 2019. Found on Page 24
- Figure 13. The industrial land that hems in the LA River, such as this example at river mile 18, is representative of over 10% of all land within the river corridor. Source: OLIN, 2018. Found on Page 25
- Figure 14. (Top) Le Ballet Dembaya, a West African percussion collective, uses the LA River Channel to perform. Source: Shabaka Johnson, Le Ballet Dembaya. Found on Page 27
- Figure 15. (Middle) The LA River can host art shows and exhibitions to showcase local art from community members. Source: Gehry Partners, 2018. Found on Page 27
- Figure 16. (Bottom) Programs such as Turnaround Arts foster art education in schools and communities along the LA River. Source: Turnaround Arts, California, <https://bit.ly/2QBK5tt>. Found on Page 27
- Figure 17. This example of an art installation at a Tier III Pavilion at river mile 28.4 portrays a data-based installation that could show real-time water quality through the color of the lights. Source: OLIN, 2019. Found on Page 28
- Figure 18. LA River Maintenance Responsibilities. Currently, the LA River and its tributaries are operated and maintained by the USACE or the FCD. This map indicates which entity has jurisdiction in different segments of the river. Source: LA County Public Works, GIS Maintenance Map, 2016. Found on Page 33
- Figure 19. Various governmental entities use differing methods to define river segments, as shown in this diagram. However, all projects permitted under these guidelines are required to reference the 51 mile LA River numbering system. This diagram is for reference only. Other entities may change their definitions over time, so consult with the applicable entity as needed. Source: LA River Master Plan, 2020. Found on Page 36
- Figure 20. LA River Planning Frames. Source: LA River Master Plan, 2020. Found on Page 41
- Figure 21. The channel conditions of LA River Planning Frame 9 range from soft bottom to trapezoidal to concrete. Much of the frame occurs in a dense residential context. Source: LA River Master Plan, 2020. Found on Page 43
- Figure 22. LA River Planning Frame 8 occurs in a dense urban and residential context and the river has a narrow, rectangular box channel section. Source: LA River Master Plan, 2020. Found on Page 45
- Figure 23. This channel condition of LA River Planning Frame 7 is a rectangular box section. Certain areas of the river have no ROW due to large private land holdings. Source: LA River Master Plan, 2020. Found on Page 47
- Figure 24. LA River Planning Frame 6 contains soft bottom river profiles and runs adjacent to Griffith Park. Source: LA River Master Plan, 2020. Found on Page 49
- Figure 25. LA River Planning Frame 5 includes the section of the river that runs through Downtown LA, often near railroads or industrial sites. Source: LA River Master Plan, 2020. Found on Page 51
- Figure 26. The river widens to a concrete trapezoidal channel in LA River Planning Frame 4, with many sites that have contamination from adjacent industrial land uses. Source: LA River Master Plan, 2020. Found on Page 53
- Figure 27. LA River Planning Frame 3 includes the section of the river that runs through South Gate, and often includes power lines from major utilities. Source: LA River Master Plan, 2020. Found on Page 55
- Figure 28. The channel in LA River Planning Frame 2 has a trapezoidal concrete section. There is a significant equestrian community that uses trails along this portion of the river. Source: LA River Master Plan, 2020. Found on Page 57
- Figure 29. The estuary in LA River Planning Frame 1 contains brackish water and is a significant bird habitat. Source: LA River Master Plan, 2020. Found on Page 59
- Figure 30. LA River Access. Access points, trails, and public transportation stops along or adjacent to the LA River. Source: LA River Master Plan, 2020. Found on Page 62
- Figure 31. Chapter 3 of this document covers items related to access and mobility along the LA River. Source: LA River Master Plan, 2020. Found on Page 65
- Figure 32. Multiuse trails can be designed in different ways depending on available width. Ideally equestrians would be separated from pedestrians and bicyclists with a buffer. Dimensions illustrated for bikes are based on the LA County Bike Plan. Source: OLIN, 2019. Found on Page 67
- Figure 33. Pedestrian, bicycle, and equestrian trail components vary in width and are most often used in combination with one another, but they may also be implemented as standalone trails in certain projects. Dimensions illustrated for bikes are based on the County of LA Bike Plan. Source: OLIN, 2019. Found on Page 68
- Figure 34. Existing right-of-way conditions vary greatly along the 51 miles of the river. In general, there are four typologies that represent the majority of conditions along the river. Source: OLIN, 2019. Found on Page 71
- Figure 35. A wide landside ROW would allow for the separation of trail types. This presents the possibility to have wide trail dimensions and highest safety measures. This figure represents one possible configuration of this typology. Source: OLIN, 2019. Found on Page 72

- Figure 36. Trails may be consolidated when a wide landside ROW is present. When the trails are consolidated, more land becomes available for parks, planting, and habitat. This figure represents one possible configuration of this typology. Source: OLIN, 2019. Found on Page 73
- Figure 37. Narrow landside ROW allow for the separation of pedestrian and bike trails. However, they do not allow room for separate equestrian trails. In this condition, room for buffer planting is present, allowing separation between the trail users and the property owners. This figure represents one possible configuration of this typology. Source: OLIN, 2019. Found on Page 74
- Figure 38. Narrow landside ROW allow for the separation of pedestrian and bike trails. However, they do not allow room for separate equestrian trails. This figure represents one possible configuration of this typology. Source: OLIN, 2019. Found on Page 74
- Figure 39. The cantilevered and elevated trails allow pedestrians and cyclists to utilize the ROW when there is not enough room between the channel and adjacent property, infrastructure, or utilities. Guardrails on both sides of the trail help keep users safe. This typology could stay open during storm events and offer elevated views. This figure represents one possible configuration of this typology. Source: OLIN, 2019. Found on Page 75
- Figure 40. For instances where there is no landside ROW, a cantilevered condition can create space for an accessible multiuse trail. This figure represents one possible configuration of this typology. Source: OLIN, 2019. Found on Page 75
- Figure 41. Wide landside ROW allow for the separation of trail types with vegetated buffers. This figure represents one possible configuration of this typology. Source: OLIN, 2019. Found on Page 76
- Figure 42. Where possible, trails should slope away from the river and to a landscape drain or infiltration zone. That water should then be filtered and conveyed into the river. Source: OLIN, 2019. Found on Page 79
- Figure 43. Paving types are not limited to those above and vary based on the intended use. Paving material thicknesses and sub-base dimensions vary according to use. Any geotechnical conditions should be studied and reviewed by a licensed State of California civil engineer. Source: All images OLIN, 2019. Found on Page 80
- Figure 44. Fences, guardrails, and railings should be utilized in the correct locations along the river. These locations are dictated by channel characteristics, user access, adjacent land uses, and programming. Source: OLIN, 2019. Found on Page 82
- Figure 45. The terms above are defined as used in this document. Source: OLIN, 2019. Found on Page 83
- Figure 46. Fence, guardrail, or gate type is determined by location on the river and the intended use. Source: OLIN, 2019. Found on Page 84
- Figure 47. Fence types along the LA River vary due to intended uses and adjacent elements. Source: (Top) OLIN / Sahar Coston-Hardy, 2013. All other images OLIN, 2019. Found on Page 85
- Figure 48. Gateway conditions vary depending on the space available. Gateways signify entrances to the LA River Trail and vary from trail access points with clear environmental graphics and minimum site-specific amenities to access points with pavilions and programming. Source: OLIN, 2019. Found on Page 87
- Figure 49. Bridge crossings are unique to the use of the bridge. The design, materiality, and form of each bridge should be determined based on the intended use. All bridge proposals shall be studied for hydraulic impacts on the flood capacity of the channel. Source: OLIN, 2019. Found on Page 89
- Figure 50. Land bridges create habitat and movement opportunities through varied planting and topography. Pedestrian, bicycle, and equestrian paths should be a minimum of 12 feet wide between railings. When possible, slope bridge paths to a maximum of 5%. If sloped up to 8.33% or more, provide landings and railings as per ADA requirements for accessible ramps. Cross-slope should be a maximum of 2%. Use clear centerline striping and environmental graphics, developed with a project's specific needs, to warn trail users of a bridge crossing and provide a clear connection to equestrian trail. Source: OLIN, 2019. Found on Page 90
- Figure 51. Pedestrian, bicycle, and equestrian paths should be a minimum of 12 feet wide between railings. When possible, slope bridge paths to a maximum of 5%. If sloped up to 8.33% or more, provide landings and railings as per ADA requirements for accessible ramps. Cross-slope should be a maximum of 2%. Use clear centerline striping and environmental graphics, developed with a project's specific needs, to warn trail users of a bridge crossing and provide a clear connection to equestrian trail. Source: OLIN, 2019. Found on Page 90
- Figure 52. Equestrian bridge to be a minimum of 12 feet wide between railings. When possible, slope equestrian bridge paths to a maximum of 5%. If sloped up to 8.33% or more, provide landings and railings as per ADA requirements for accessible ramps. Cross-slope should be a maximum of 2%. Use clear centerline striping and environmental graphics, developed with a project's specific needs, to warn trail users of a bridge crossing and provide a clear connection to equestrian trail. Source: OLIN, 2019. Found on Page 91
- Figure 53. Pedestrian and bicycle paths should be a minimum of 12 feet wide between railings. When possible, slope bridge paths to a maximum of 5%. If sloped up to 8.33% or more, provide landings and railings as per ADA requirements for accessible ramps. Cross-slope should be a maximum of 2%. Use clear centerline striping and environmental graphics, developed with a project's specific needs, to warn trail users of a bridge crossing. Source: OLIN, 2019. Found on Page 91
- Figure 54. Lighting, safety, grading, and opportunities for art are key design considerations at underpass locations. Source: OLIN, 2019. Found on Page 92
- Figure 55. Environmental graphics help to define river gateways, as shown in this Shade Pavilion example at river mile 14.7. Source: OLIN, 2019. Found on Page 96
- Figure 56. Chapter 4 of this document covers items related to environmental graphics that are present on and along the LA River. Source: LA River Master Plan, 2020. Found on Page 99
- Figure 57. Character height required for ADA accessibility is based on horizontal viewing distance. Designers should check the latest ADA standards for updates. Source: Standards from U.S. Department of Justice. (2010). 2010 ADA Standards for Accessible Design. Washington, DC: U.S. Department of Justice. Found on Page 101
- Figure 58. Single or double posts are required for signs directly overhanging on circulation paths depending on the height they are located and the amount of sign protruding beyond the post. Designers should check the latest ADA standards for updates. Source: Standards from U.S. Department of Justice. (2010). 2010 ADA Standards for Accessible Design. Washington, DC: U.S. Department of Justice. Found on Page 101
- Figure 59. MUTCD symbols, for example ones for pedestrians, cyclists, equestrians, restrooms, first aid, drinking water, bus stop, kayaking, and litter receptacle, should be used on signs where possible. Source: 2009 MUTCD Edition with Revisions 1 and 2, 2012. Found on Page 102
- Figure 60. The heron icon should be used when a logo for the LA River is needed, such as on a sign. Source: Edited for the LA River Master Plan, 2020 from the LA River Sign Guidelines, 2003. Found on Page 102
- Figure 61. The terminology and font on all environmental graphics should be "LA River" in Barlow. Source: OLIN, 2019. Found on Page 102
- Figure 62. When a symbol is needed that is not available from MUTCD, another symbol in a similar style and weight to MUTCD standards should be used. Examples include of symbols for gender-neutral restrooms, river crossings, a river confluence, and wetlands. Source: (Left) Title 24 of the California Code of Regulations, California Building Code, 2016; all other symbols, River LA. Found on Page 102

- Figure 63. The heron graphic should be used for large scale environmental graphics or other identifying environmental graphics. Source: LA River Master Plan, 2020. Found on Page 102
- Figure 64. Barlow is an open-source typeface designed by Jeremy Tribby and is available from Google Fonts. "Semi-bold" through "black" thicknesses are recommended for environmental graphics intended to be read from a distance or while traveling at a fast speed. Source: OLIN, 2019. Found on Page 103
- Figure 65. The approach to the placement and sequence of environmental graphics depends on the context and expected volume and speed of users passing by. The diagram above shows an abstraction of different contexts for environmental graphics leading to and along the LA River. Example scenarios are depicted on the pages that follow. Source: OLIN, 2019. Found on Page 104
- Figure 66. Environmental graphics along arterial roads should guide users across busy intersections. Source: OLIN, 2019. Found on Page 106
- Figure 67. Environmental graphics along vehicular bridges alert drivers to the presence of the LA River. Source: OLIN, 2019. Found on Page 107
- Figure 68. Environmental graphics along collector roads guide users towards the river and also allow for community expression. Source: OLIN, 2019. Found on Page 108
- Figure 69. Environmental graphics along local roads guide users through residential areas. Source: OLIN, 2019. Found on Page 109
- Figure 70. Environmental graphics at gateways should avoid sign clutter. Source: OLIN, 2019. Found on Page 110
- Figure 71. Environmental graphics along the LA River help locate and inform trail users. Source: OLIN, 2019. Found on Page 111
- Figure 72. The suite of LA River environmental graphics includes signs leading to the LA River and signs within projects along the LA River. Source: OLIN, 2019. Found on Page 112
- Figure 73. Baseline requirements for environmental graphics leading to the LA River and projects within the LA County Flood Control District right-of-way depend on the scale of the project. Directional signage is required to be two miles away from an XL project, while only required to be 500 feet away from an S project. Directional signage for bicycles are required only for XL-M projects. At gateways, Information signage and Regulatory environmental graphics are required for S-XL projects. Within an XS project, Interpretive, River Mile Pavement Markings, and River Mile Markers are required. Confirmation signs are required with S-XL projects. Incorporation of Large Scale Graphics with L and XL projects should be considered. Source: OLIN, 2019. Found on Page 114
- Figure 74. This matrix lists the minimum design feature requirements for each category of environmental graphics. Specific requirements will be determined on a project by project basis. These parameters provide the best practices for clear, uncluttered text layout and consistency. Source: OLIN, 2019. Found on Page 116
- Figure 75. Freestanding informational environmental graphics should be on double posts with the bottom of the sign between 40" and 45" minimum above grade. Source: OLIN, 2019. Found on Page 118
- Figure 76. Informational signs provide the location name, owner, operator, and funding source of a project, along with trail usage symbols denoting types of trails available. Source: OLIN, 2019. Found on Page 119
- Figure 77. The information panel allows for ease of updating information such as management and funding. Source: OLIN, 2019. Found on Page 120
- Figure 78. Regulatory environmental graphics should be placed so that the bottom-most text is between 40"-70" above grade. Certain freestanding signs require double posts. Source: OLIN, 2019. Found on Page 121
- Figure 79. Regulatory Rule signs alert park and trail users to the rules and regulations in effect within river parks and on trails, and must be bilingual. Source: OLIN, 2019. Found on Page 122
- Figure 80. Regulatory Warnings signs alert users of flood dangers and trail violations should be placed on gates or fences at entrances to the trail. Source: OLIN, 2019. Found on Page 123
- Figure 81. The signs shown above (1-4) are examples of warning and safety regulations signs that are standard designs and must not be altered. These guidelines do not provide artwork for these standard signs. Designers should consult latest MUTCD guidelines. Source: 2009 MUTCD Edition with Revisions 1 and 2, 2012. Found on Page 124
- Figure 82. The signs shown to the left (5-6) are standard regulatory signs, created as part of these guidelines, that must not be altered. Artwork for these standard signs can be downloaded here: [www.larivermasterplan.org/resources](http://www.larivermasterplan.org/resources) Found on Page 124
- Figure 83. Confirmation environmental graphics should be placed so that the "LA River" text is between 70"-120" above grade. Source: OLIN, 2019. Found on Page 126
- Figure 84. Confirmation signs confirm to the viewer that they are traveling the correct direction and identify the next closest major destinations. They can also indicate arrival at a destination with the addition of an arrow. Source: OLIN, 2019. Found on Page 127
- Figure 85. This Confirmation sign should be used at locations such as bridge crossings to confirm the location of the LA River. Source: OLIN, 2019. Found on Page 128
- Figure 86. Confirmation maps help users locate where they are on the trail in relation to the river system and the trail itself, and help to locate other access points. Source: OLIN, 2019. Found on Page 129
- Figure 87. This Confirmation sign should be used for bike routes leading to LA River. Source: OLIN, 2019. Found on Page 130
- Figure 88. A Street Identifying signs should be located above the LA River trail denoting name of street above, crossing over the trail. Source: OLIN, 2019. Found on Page 130
- Figure 89. Interpretive environmental graphics should be placed at a height that is easily legible. When freestanding, larger signs should be on double posts. Installing and fabricating these types of signs on an angle is recommended. Angle to be determined based on height and use. Source: OLIN, 2019. Found on Page 131
- Figure 90. The content grid of the Interpretive sign provides a template for the layout of content. Source: OLIN, 2019. Found on Page 132
- Figure 91. There are many different ways that the grid can be used for the layout of Interpretive signs. The above example shows one method of basic organization with a hierarchy of text sizes. Source: OLIN, 2019. Found on Page 132
- Figure 91. Images or maps should also be incorporated into Interpretive signs as focal points. Source: OLIN, 2019. Found on Page 133
- Figure 92. Large callouts or quotes can be incorporated into Interpretive signs to highlight key information. QR codes can also be added as an additional resource to learn more. Source: OLIN, 2019. Found on Page 133
- Figure 93. Sample content for smaller Interpretive signs, typically located low to the ground in a planted area. Content for these signs will vary. Source: OLIN, 2021. Found on Page 134
- Figure 94. Interpretive signs should be installed and fabricated so that face of sign is angled up. Angle to be determined based on height and use. Source: OLIN, 2021. Found on Page 135
- Figure 95. Directional environmental graphics should be placed along bike routes leading to the LA River and its access points and projects. Estimated times are based on an average six minute mile. Source: OLIN, 2019. Found on Page 136
- Figure 96. Important guidelines as prescribed by the Manual on Uniform Traffic Control Devices for Streets and Highways. Source: 2009 MUTCD Edition with Revisions 1 and 2, 2012. Found on Page 137

- Figure 97. Directional environmental graphics, communicating to both pedestrians and bicyclists, lead to the LA River and its access points and projects from a maximum of two miles away. Source: OLIN, 2019. Found on Page 137
- Figure 98. Place directional bike route signs along bike routes leading to LA River. These signs include a directional arrow, the distance to LA River, and the estimated time to bike there. Source: OLIN, 2019. Found on Page 138
- Figure 99. This LA River Bike Route sign can be mounted above another MUTCD Bike Route sign within 2 miles of LA River access points. Source: OLIN, 2019. Found on Page 139
- Figure 100. This LA River bike route sign can be mounted above another MUTCD Bike Route sign within 2 miles of LA River access points. Source: OLIN, 2019. Found on Page 139
- Figure 101. LA River Directional Bike Destination sign panels direct users to major destinations and provide the distance and estimated time to bike there. Separate panels allow for multiple destinations to be added over time. Source: OLIN, 2019. Found on Page 140
- Figure 102. This LA River directional bike destination sign combination allows for all three destinations to live on a singular sign. Source: OLIN, 2019. Found on Page 141
- Figure 103. Large directional signs provide direction and distance to the LA River and serve as a visual marker. Source: OLIN, 2019. Found on Page 142
- Figure 104. LA River directional destination sign panels direct users to major destinations and the distances to them. At a maximum, three should be stacked together per MUTCD guidelines. Source: OLIN, 2019. Found on Page 143
- Figure 105. LA River large directional signs should be used within 0.5 miles from the LA River. Mile numbers do not appear on signs within 0.5 miles of the destination. Source: OLIN, 2019. Found on Page 144
- Figure 106. LA River bike route directional sign does not show the distance and estimated time when within 0.5 miles of the LA River. Source: OLIN, 2019. Found on Page 144
- Figure 107. River mile markers must appear every 0.5 miles along the LA River. The mile number and bank side are clear and helpful indicators for travelers and emergency responders. Found on Page 145
- Figure 108. River mile markers should be located on the landside of the trail with the bottom of the sign 40" above grade. Source: OLIN, 2019. Found on Page 145
- Figure 109. LA River mile pavement markings alert users to their river mile location along the river. Source: OLIN, 2019. Found on Page 146
- Figure 110. River mile pavement markings should be placed so that they face the direction of travel. Source: OLIN, 2019. Found on Page 147
- Figure 111. River miles at existing bridges over the LA River. Where a bridge is angled across the channel, localized judgement on a project basis is needed to determine if different river mile numbers should be used on opposite sides. Source: OLIN, 2021. Found on Page 148
- Figure 112. LA River trail river mile markers should be located along both sides of the river using existing bridges as benchmarks. Source: OLIN, 2021. Found on Page 149
- Figure 113. Underpasses are an opportunity for large scale icon graphics and can alert users to their river mile location. Source: OLIN, 2019. Found on Page 150
- Figure 114. Bridges and overpasses are opportunities for large scale icon graphics and can alert users to street crossings underneath. Source: OLIN, 2019. Found on Page 150
- Figure 115. Pavement Markings can be customized along the LA River trail at gateways to allow for the integration of community expression. Source: OLIN, 2019. Found on Page 152
- Figure 116. Elements of informational environmental graphics, interpretive signs and displays, and large scale icon graphics can all be customized for specific projects. Designers can create their own approaches within the outlined parameters on a project by project basis. Source: OLIN, 2019. Found on Page 153
- Figure 117. Common layers of an aluminum sign include anti-graffiti film or coating, printed vinyl, and retroreflective substrate on aluminum. The best application of applied graphics using vinyl or print is to be determined by fabricator. Always confirm with the fabricator that graphics are protected for exterior environments. Source: OLIN, 2019. Found on Page 155
- Figure 118. Aluminum with rounded corners is used as the base of many types of signs. Source: OLIN, 2019. Found on Page 156
- Figure 120. New sign posts should be RAL 9007. Found on Page 156
- Figure 119. Retroreflective substrates, colored film, and clear anti-graffiti film layer on top of aluminum to create the graphic of a sign. Source: OLIN, 2019. Found on Page 156
- Figure 121. There are many options of paint for River Mile Pavement Markings. Thermoplastic and water-based paints are recommended for use along the LA River based on their durability and environmental impact. Source: OLIN, 2019. Found on Page 157
- Figure 122. Thermoplastic paint is a durable option for River Mile Pavement Markings on asphalt. Source: LeManna, Shutterstock.com, 2020. Found on Page 157
- Figure 123. Vegetation Classification. Much of the vegetation around the LA River is degraded or mostly comprised of non-native plant species. Source: LA River Master Plan, 2020. Found on Page 160
- Figure 124. Chapter 5 of this document covers items related to ecology, habitat, and planting in and along the LA River. Source: LA River Master Plan, 2020. Found on Page 163
- Figure 125. Depicted here with a 4x vertical exaggeration, the LA River changes approximately 780 feet in elevation over its course of 51 miles and passes through several distinct ecological reaches, from the San Fernando Valley to the Estuary. Source: OLIN, 2019. Found on Page 165
- Figure 126. Along entrenched portions of the channel, the LACFCD requires a 17-foot Limited Landscape Management Zone that prohibits any structures and limits planting to shrubs and groundcovers up to 3-5 feet in height. The USACE guidelines require a 15-foot Vegetation Free Zone that limits planting to grasses and shallow-rooting perennials near levees or floodwalls. This distance is measured from either the landside edge of the levee, the top of a levee with a planting berm, or from the edge of a flood wall. Source: OLIN, 2019. Found on Page 167
- Figure 127. Planting along the landside of levees is achievable through the creation of a planting berm that includes a 3-foot root-free zone off the landside slope of the levee. This planting must follow the latest USACE requirements as stated in the Guidelines for Landscape Planting and Vegetation Management at Levees, Floodwalls, Embankment Dams, and Appurtenant Structures. Source: Drawing based on US Army Corps of Engineers Guidelines for Landscape Planting and Vegetation Management at Levees, Floodwalls, Embankment Dams, and Appurtenant Structures, 2014. Found on Page 169
- Figure 128. Planting along floodwalls is achievable as long as the vegetation-free zone is kept clear of shrubs and trees. Planting along floodwalls must follow the USACE requirements as stated in the Guidelines for Landscape Planting and Vegetation Management at Levees, Floodwalls, Embankment Dams, and Appurtenant Structures. Source: Drawing based on US Army Corps of Engineers Guidelines for Landscape Planting and Vegetation Management at Levees, Floodwalls, Embankment Dams, and Appurtenant Structures, 2014. Found on Page 169
- Figure 129. Proper ingress and egress clearance must be allowed for maintenance vehicles. The above example considers requirements for a maintenance ramp into an entrenched portion of the river channel, which includes, but is not limited to, the turning radius, direction of flow, and the limited landscape management zone. Source: OLIN, 2019. Found on Page 170



- Figure 130. Tree limbing height requirements vary based on the location of the tree, the programmed use of the area, and visibility requirements. Young trees are exempt from these requirements and should not be limbed until they have reached maturity. Source: OLIN, 2019. Found on Page 171
- Figure 131. Requirements for planting in a utility ROW vary depending on the specific utility agency, but often include limitations on the installation of vegetation of a certain height or within a specified distance to the utility's infrastructure. Source: OLIN, 2019. Found on Page 172
- Figure 132. Clear lines of sight and consistently lit paths of travel should be included at gateways and access points. Source: OLIN, 2019. Found on Page 175
- Figure 133. Lighting along the LA River trail should be consistent and should not be blocked by tree limbs or any other obstructions. Source: OLIN, 2019. Found on Page 175
- Figure 134. Access points where a street drains into the river provide opportunities to capture and treat stormwater. Swales along trails that slope away from the river also provide opportunities for water treatment. Source: OLIN, 2019. Found on Page 176
- Figure 135. A densely planted buffer consisting of trees, shrubs, and groundcovers creates a unique sense of place along the LA River and provides opportunities to create connected habitats. Source: OLIN, 2019. Found on Page 177
- Figure 136. If a trail is designed to slope towards a planted swale, it can collect, convey, and treat stormwater before it reaches the LA River. Source: OLIN, 2019. Found on Page 177
- Figure 137. New projects along the LA River offer the opportunity to change the typical condition of stormdrain pipes that flow underneath street ends and exit directly into the river channel. Source: OLIN, 2019. Found on Page 179
- Figure 138. A daylight storm drain allows for infiltration and treatment of runoff before it enters the LA River. These types of projects can help improve the water quality in the river. Source: OLIN, 2019. Found on Page 179
- Figure 139. Various BMP techniques can be implemented depending on the space available and intended use. Source: (Top) OLIN, 2018, (Middle) OLIN, 2018, (Bottom) Roger Soh, 2010. Found on Page 180
- Figure 140. The infrastructure of each BMP varies based on project needs and should be designed with engineers. Source: OLIN, 2019. Found on Page 181
- Figure 141. Ideas on variations of channel modifications help push the envelope of what is possible along the LA River. Hydraulic analysis and coordination with engineers is necessary to bring these ideas to fruition. Source: OLIN, 2019. Found on Page 183
- Figure 142. The trapezoidal channel could be modified to create large terraces for habitat. Consultation with qualified engineers and hydraulic analysis is necessary. This is not a solution for all 51 miles of the LA River. Source: OLIN, 2019. Found on Page 185
- Figure 143. The trapezoidal channel could be modified to create a public amphitheater. Consultation with qualified engineers and hydraulic analysis is necessary. This is not a solution for all 51 miles of the LA River. Source: OLIN, 2019. Found on Page 185
- Figure 144. The rectangular channel could be modified to create large amphitheaters, a performance venue, or ramps for wildlife. Consultation with qualified engineers and hydraulic analysis is necessary. For sections of these conditions, See Figure 146 on page 187. Source: OLIN, 2019. Found on Page 186
- Figure 145. The rectangular channel could be modified to create a bioswale to collect and treat water before it enters the LA River. Consultation with qualified engineers and hydraulic analysis is necessary. This is not a solution for all 51 miles of the LA River. Source: OLIN, 2019. Found on Page 187
- Figure 146. The rectangular channel could be modified to create large amphitheaters, a performance venue, or ramps for wildlife. Consultation with qualified engineers and hydraulic analysis is necessary. Source: OLIN, 2019. Found on Page 187
- Figure 147. To ensure the healthy growth of planting, the following soil depths should be implemented over structure. The required depths, drainage, and waterproofing need to be coordinated across the project team. Source: OLIN, 2019. Found on Page 188
- Figure 149. Platform construction is complex and should be designed per project by the design team. Service trucks will need to have access underneath the platform. Consultation with qualified engineers and hydraulic analysis is necessary. This is not a solution for all 51 miles of the LA River. Source: OLIN, 2019. Found on Page 189
- Figure 148. Platform program and design may vary to include a range of ecological functions, recreational amenities, or passive park space. Platforms cannot be used over soft bottom portions of the channel or in the estuary. Platforms cannot be used for development, only for open space. This is not a solution for all 51 miles of the LA River. Source: OLIN, 2019. Found on Page 189
- Figure 150. The creation of urban agricultural and community gardens along the LA River is encouraged and provides opportunities for education, access to fresh food, and a sense of stewardship in landscapes along the river. Productive landscapes are not subject to the same native planting or water requirements as other areas. Source: Craig Dietrich, 2011. Found on Page 191
- Figure 151. Tree protection should be coordinated with the project arborist. Protection fencing should be placed along the dripline of existing trees. Source: OLIN, 2019. Found on Page 192
- Figure 152. (Left) Tree protection also includes wood slats around the trunk of existing trees and they should be removed after construction. Source: OLIN, 2019. Found on Page 193
- Figure 153. (Top Right) Protective wire cages around shrubs susceptible to wildlife grazing can help protect them during establishment. Source: OLIN, 2019. Found on Page 193
- Figure 154. (Bottom Right) Gopher cages help protect shrub rootballs from burrowing wildlife during establishment. Source: OLIN, 2019. Found on Page 193
- Figure 155. Ensuring proper soil testing and composition is crucial to supporting the life and structure of healthy functioning ecosystems. Soil mixes should be designed for it criteria of use, and all soils should be tested for suitability prior to installation. Source: OLIN, 2019. Found on Page 195
- Figure 156. Planting installation methods should include scarifying the subgrade, aligning all root flares with the finished grade, and providing a compacted base for rootballs to provide the best growing conditions and allow the planted media to have the best chance of success. Source: OLIN, 2019. Found on Page 197
- Figure 157. Native planting along the LA River, as seen here at the North Valleyheart Riverwalk at river mile 39.7, should be incorporated into the trail access points. Source: OLIN, 2019. Found on Page 199
- Figure 158. Gabion walls are often a more economical option for grade retention and allow for a substantial amount of planting near the wall. Gabion walls should be designed with a structural engineer. Source: OLIN, 2019. Found on Page 200
- Figure 159. Site walls may function as barriers, seat walls, or decorative elements and should be designed with a structural engineer. Source: OLIN, 2019. Found on Page 201
- Figure 160. Retaining walls achieve a significant change in grade over a relatively narrow space and should be designed with a structural engineer. Source: OLIN, 2019. Found on Page 201
- Figure 161. Geogrid mats, erosion mats, and hydroseeding are examples of strategies for slope stabilization on steep landside levee slopes. Slope stabilization should occur both during and after construction. The growth of deep rooting shrubs and groundcovers should be encouraged as a long-term slope stabilization method as permissible by levee planting standards. Source: OLIN, 2019. Found on Page 202

- Figure 162. Armoring the landside slope of a levee is a technique that helps prevent levee failure under extreme overtopping events and strengthens the resilience of the levee over time. It also allows for the construction of a planting berm that supports trees and shrubs. Source: OLIN, 2019. Found on Page 203
- Figure 163. Historic Fire Occurrences Map. While native plant communities are adapted to occasional fires, the increased frequency of wildfires threatened the establishment of native shrubs and trees and favors non-native invasive species. Several design and maintenance strategies can help reduce this threat to native habitat. Source: State of California and the Department of Forestry and Fire Protection, Fire Perimeters Version 17\_1, 2017. Found on Page 205
- Figure 164. Vertical structure in planting varies depending on the type of native plant community. Woodland and forest communities tend to have large canopies, while scrub and chaparral communities tend to have primarily understory and shrub layers. Source: OLIN, 2019. Found on Page 207
- Figure 165. Areas of refuge for fish include areas where nutrients accumulate or where protection of birds and other predators is offered, such as outer banks, shaded and calm areas, eddies, boulders or islands, and areas where currents merge. If working within the boundaries of the river channel, adding additional vegetation and boulders may impact flows and flood capacity of the river and should only be pursued with consultation of qualified engineers and hydraulic analysis. Source: "River Fishing." Takemefishing.org. Recreational Boating & Fishing Foundation. Accessed 2021. <https://www.takemefishing.org/freshwater-fishing/types-of-freshwater-fishing/river-fishing/>. Found on Page 207
- Figure 166. Plant communities in different contexts can host diverse types wildlife. The example above shows a soft-bottom basin condition of either an existing or proposed river section. The species listed are meant to be a snapshot of a full list to be developed with a qualified ecologist and assume appropriate soil and plant community health to support the wildlife species. For more details, reference Chapter 6 of Appendix Volume II: Technical Backup Document. Source: OLIN, 2019. Found on Page 209
- Figure 167. A variety of site furnishings can be placed in areas suitable for fishing. Fish processing stations are a valuable amenity for filleting fish. Typical fish processing stations include a wide cutting table, accessory tray, and attached hose for cleanup. Fishing rod holders and measuring boards can be installed to help keep the area free of clutter and also ensure that only the fish of appropriate sizes deemed by local fish and wildlife regulations are kept for processing, while the rest are caught and released. Source: OLIN, 2021. Found on Page 211
- Figure 168. The chaparral community is often found on exposed slopes and hillsides, such as this example in the Santa Monica Mountains. Source: Tracie Hall, <https://www.flickr.com/photos/twobears2/5190609445/> (Topanga State Park, 2010). Found on Page 213
- Figure 169. The coast live oak woodland can be found on slopes or on river banks and terraces, such as this example in Malibu Creek State Park. Source: Tracie Hall, <https://www.flickr.com/photos/twobears2/5193454253/in/photostream/> (Malibu Creek State Park, 2010). Found on Page 213
- Figure 170. Terms and Definitions for Native Plant Species. Terms are defined as used in this document. Source: USDA, USEPA. Found on Page 214
- Figure 171. Species planting at gateways and along street frontages can incorporate more climate-adapted species, while riparian and other habitat areas should prioritize planting locally-sourced LA River watershed native plant species. Source: OLIN, 2019. Found on Page 215
- Figure 172. *Platanus racemosa*. Source: Raffi Kojian, <http://www.gardenology.org>, <https://commons.wikimedia.org/w/index.php?curid=9705655>. Found on Page 222
- Figure 173. *Quercus agrifolia*. Source: Stickpen, <https://commons.wikimedia.org/w/index.php?curid=9944130>. Found on Page 222
- Figure 174. *Umbellularia californica*. Source: Krzysztof Ziarnik, Kenraiz, <https://commons.wikimedia.org/w/index.php?curid=54448438>. Found on Page 222
- Figure 175. *Frangula californica*. Source: Krzysztof Ziarnik, Kenraiz, <https://commons.wikimedia.org/w/index.php?curid=37322426>. Found on Page 222
- Figure 176. *Mimulus aurantiacus*. Source: Franz Xaver, <https://commons.wikimedia.org/w/index.php?curid=17165632>. Found on Page 222
- Figure 177. *Salvia mellifera*. Source: Jerry Kirkhart, Black Sage, <https://commons.wikimedia.org/w/index.php?curid=43169351>. Found on Page 222
- Figure 178. *Salvia spathacea*. Source: peganum, <https://commons.wikimedia.org/w/index.php?curid=37049932>. Found on Page 222
- Figure 179. *Solidago californica*. Source: Stickpen, <https://commons.wikimedia.org/w/index.php?curid=8092464>. Found on Page 222
- Figure 180. *Clematis ligusticifolia*. Source: Stan Shebs, <https://commons.wikimedia.org/w/index.php?curid=5376939>. Found on Page 222
- Figure 181. *Sambucus nigra* ssp. *caerulea*. Source: Stan Shebs, <https://commons.wikimedia.org/w/index.php?curid=1953423>. Found on Page 230
- Figure 182. *Lepidospartum squamatum*. Source: Anthony Valois and the National Park Service, [http://researchlearningcenter.org/bloom/species/Lepidospartum\\_squamatum.htm](http://researchlearningcenter.org/bloom/species/Lepidospartum_squamatum.htm) and <https://commons.wikimedia.org/w/index.php?curid=6011633>. Found on Page 230
- Figure 183. *Artemisia californica*. Source: Daderot, <https://commons.wikimedia.org/w/index.php?curid=75807390>. Found on Page 230
- Figure 184. *Eriogonum fasciculatum* var. *fasciculatum*. Source: Dominic, <http://www.inaturalist.org/photos/2067855>. Found on Page 230
- Figure 185. *Eriodictyon trichocalyx*. Source: Jim Morefield, <https://www.inaturalist.org/photos/14141764>. Found on Page 230
- Figure 186. *Salvia apiana*. Source: Laura Camp, <https://www.flickr.com/photos/lauracamp/16355349843>. Found on Page 230
- Figure 187. *Cylindropuntia californica* var. *parkeri*. Source: Stan Spencer, [https://calphotos.berkeley.edu/cgi/img\\_query?enlarge=0000+0000+0409+1587](https://calphotos.berkeley.edu/cgi/img_query?enlarge=0000+0000+0409+1587). Found on Page 230
- Figure 188. *Croton californicus*. Source: Stan Shebs, <https://commons.wikimedia.org/w/index.php?curid=5915540>. Found on Page 230
- Figure 189. *Yucca whipplei*. Source: Stan Shebs, <https://commons.wikimedia.org/w/index.php?curid=2826038>. Found on Page 230
- Figure 190. *Sambucus nigra* ssp. *caerulea*. Source: Stan Shebs, <https://commons.wikimedia.org/w/index.php?curid=1953423>. Found on Page 238
- Figure 191. *Baccharis pilularis* var. *consanguinea*. Source: Miguel Vieira, <https://commons.wikimedia.org/w/index.php?curid=9389145>. Found on Page 238
- Figure 192. *Artemisia californica*. Source: Daderot, <https://commons.wikimedia.org/w/index.php?curid=75807390>. Found on Page 238
- Figure 193. *Eriogonum fasciculatum* var. *fasciculatum*. Source: Dominic, <http://www.inaturalist.org/photos/2067855>. Found on Page 238
- Figure 194. *Isocoma menziesii* ssp. *vernonioides*. Source: Miguel Vieira, <https://commons.wikimedia.org/w/index.php?curid=9389145>. Found on Page 238
- Figure 195. *Epilobium canum* ssp. *canum*. Source: Krzysztof Ziarnik, Kenraiz, <https://commons.wikimedia.org/w/index.php?curid=54696863>. Found on Page 238
- Figure 196. *Corethrogyne filaginifolia* var. *filaginifolia*. Source: John Rusk, [https://www.flickr.com/photos/john\\_d\\_rusk/21207961929](https://www.flickr.com/photos/john_d_rusk/21207961929). Found on Page 238
- Figure 197. *Yucca whipplei*. Source: Stan Shebs, <https://commons.wikimedia.org/w/index.php?curid=2826038>. Found on Page 238
- Figure 198. *Stipa lepida*. Source: John Rusk, <https://commons.wikimedia.org/w/index.php?curid=59287600>. Found on Page 238

- Figure 199. *Juglans californica*. Source: Consultaplantas, <https://commons.wikimedia.org/w/index.php?curid=44978241>. Found on Page 246
- Figure 200. *Cercocarpus betuloides*. Source: Lazaregagnidze, <https://commons.wikimedia.org/w/index.php?curid=32918241>. Found on Page 246
- Figure 201. *Ceanothus oliganthus*. Source: Anthony Valois and the National Park Service, 2004. [http://researchlearningcenter.org/bloom/species/Ceanothus\\_oliganthus.htm](http://researchlearningcenter.org/bloom/species/Ceanothus_oliganthus.htm). Found on Page 246
- Figure 202. *Prunus ilicifolia* ssp. *ilicifolia*. Source: John Rusk, <https://commons.wikimedia.org/w/index.php?curid=59290247>. Found on Page 246
- Figure 203. *Heteromeles arbutifolia*. Source: Miguel Vieira, <https://commons.wikimedia.org/w/index.php?curid=19525268>. Found on Page 246
- Figure 204. *Rhus ovata*. Source: Bri Weldon, <https://www.flickr.com/photos/briweldon/5228764249>. Found on Page 246
- Figure 205. *Eriophyllum confertiflorum*. Source: Björn S..., <https://www.flickr.com/photos/40948266@N04/43163438812>. Found on Page 246
- Figure 206. *Lotus scoparius* (*Acmispon glaber*). Source: glmory, <https://commons.wikimedia.org/w/index.php?curid=32092287>. Found on Page 246
- Figure 207. *Stipa pulchra*. Source: Matt Lavin. [https://www.flickr.com/photos/plant\\_diversity/35034340452](https://www.flickr.com/photos/plant_diversity/35034340452). Found on Page 246
- Figure 208. *Quercus agrifolia*. Source: Stickpen, <https://commons.wikimedia.org/w/index.php?curid=9944130>. Found on Page 254
- Figure 209. *Fraxinus velutina* var. *coriacea*. Source: Kenraiz, <https://commons.wikimedia.org/w/index.php?curid=75992775>. Found on Page 254
- Figure 210. *Platanus racemosa*. Source: Raffi Kojian, <http://www.gardenology.org>, <https://commons.wikimedia.org/w/index.php?curid=9705655>. Found on Page 254
- Figure 211. *Populus trichocarpa*. Source: Daniel Mayer, <https://commons.wikimedia.org/w/index.php?curid=7381945>. Found on Page 254
- Figure 212. *Keckiella cordifolia*. Source: Björn S..., [https://commons.wikimedia.org/wiki/File:Heartleaf\\_Keckiella\\_-\\_Keckiella\\_cordifolia\\_\(43818527031\).jpg](https://commons.wikimedia.org/wiki/File:Heartleaf_Keckiella_-_Keckiella_cordifolia_(43818527031).jpg). Found on Page 254
- Figure 213. *Ribes aureum* var. *gracillimum*. Source: John Rusk, [https://www.flickr.com/photos/john\\_d\\_rusk/8941180855](https://www.flickr.com/photos/john_d_rusk/8941180855). Found on Page 254
- Figure 214. *Artemisia douglasiana*. Source: Römert, <https://commons.wikimedia.org/w/index.php?curid=19802958>. Found on Page 254
- Figure 215. *Rosa californica*. Source: Bill Leikam, <https://commons.wikimedia.org/w/index.php?curid=40893617>. Found on Page 254
- Figure 216. *Dryopteris arguta*. Source: John Rusk, <https://commons.wikimedia.org/w/index.php?curid=59291429>. Found on Page 254
- Figure 217. *Quercus agrifolia*. Source: Stickpen, <https://commons.wikimedia.org/w/index.php?curid=9944130>. Found on Page 262
- Figure 218. *Sambucus nigra* ssp. *caerulea*. Source: Stan Shebs, <https://commons.wikimedia.org/w/index.php?curid=1953423>. Found on Page 262
- Figure 219. *Umbellularia californica*. Source: Krzysztof Ziarnik, Kenraiz, <https://commons.wikimedia.org/w/index.php?curid=54448438>. Found on Page 262
- Figure 220. *Prunus ilicifolia* ssp. *ilicifolia*. Source: John Rusk, <https://commons.wikimedia.org/w/index.php?curid=59290247>. Found on Page 262
- Figure 221. *Ribes californicum*. Source: Tom Hilton, [https://commons.wikimedia.org/wiki/File:Ribes\\_californicum.jpg](https://commons.wikimedia.org/wiki/File:Ribes_californicum.jpg). Found on Page 262
- Figure 222. *Rhus aromatica*. Source: David J. Stang, <https://commons.wikimedia.org/w/index.php?curid=61092418>. Found on Page 262
- Figure 223. *Sisyrinchium bellum*. Source: Franco Folini, <https://www.flickr.com/photos/livenature/4350730696>. Found on Page 262
- Figure 224. *Bromus carinatus* var. *carinatus*. Source: Matt Lavin, <https://commons.wikimedia.org/w/index.php?curid=25134214>. Found on Page 262
- Figure 225. *Muhlenbergia rigens*. Source: Krzysztof Ziarnik, Kenraiz, <https://commons.wikimedia.org/w/index.php?curid=54450777>. Found on Page 262
- Figure 226. *Populus fremontii*. Source: CK Kelly, <https://www.inaturalist.org/photos/10765354>. Found on Page 270
- Figure 227. *Salix laevigata*. Source: no attribution necessary. Found on Page 270
- Figure 228. *Salix exigua*. Source: Thayne Tuason, <https://commons.wikimedia.org/w/index.php?curid=67414102>. Found on Page 270
- Figure 229. *Salix lasiandra*. Source: Matt Lavin, <https://commons.wikimedia.org/w/index.php?curid=22760167>. Found on Page 270
- Figure 230. *Salix lasirolepis*. Source: Par Stan Shebs, <https://commons.wikimedia.org/w/index.php?curid=7556942>. Found on Page 270
- Figure 231. *Mimulus cardinalis*. Source: Dcrjsr, <https://commons.wikimedia.org/w/index.php?curid=42183047>. Found on Page 270
- Figure 232. *Juncus patens*. Source: Daderot, <https://commons.wikimedia.org/w/index.php?curid=37530402>. Found on Page 270
- Figure 233. *Agrostis exarata*. Source: sarahnwilson, <https://www.inaturalist.org/photos/19749167>. Found on Page 270
- Figure 234. *Carex praegracilis*. Source: Katie Hetrick, [https://commons.wikimedia.org/wiki/File:Carex\\_praegracilis\\_-\\_Spring\\_in\\_the\\_Mary\\_Wattis\\_Brown\\_Garden\\_of\\_California\\_Native\\_Plants.jpg](https://commons.wikimedia.org/wiki/File:Carex_praegracilis_-_Spring_in_the_Mary_Wattis_Brown_Garden_of_California_Native_Plants.jpg). Found on Page 270
- Figure 235. *Platanus racemosa*. Source: Raffi Kojian, <http://www.gardenology.org>, <https://commons.wikimedia.org/w/index.php?curid=9705655>. Found on Page 276
- Figure 236. *Fraxinus velutina* var. *coriacea*. Source: Kenraiz, <https://commons.wikimedia.org/w/index.php?curid=75992775>. Found on Page 276
- Figure 237. *Populus fremontii*. Source: CK Kelly, <https://www.inaturalist.org/photos/10765354>. Found on Page 276
- Figure 238. *Amorpha fruticosa*. Source: Leonora (Ellie) Enking, <https://www.flickr.com/photos/33037982@N04/14428257254>. Found on Page 276
- Figure 239. *Baccharis salicifolia*. Source: Krzysztof Ziarnik, Kenraiz, <https://commons.wikimedia.org/w/index.php?curid=54913701>. Found on Page 276
- Figure 240. *Rhamnus ilicifolia*. Source: Charlie Hohn, <https://www.inaturalist.org/photos/7262866>. Found on Page 276
- Figure 241. *Rubus ursinus*. Source: Gaia Leo, <https://commons.wikimedia.org/w/index.php?curid=68610213>. Found on Page 276
- Figure 242. *Thalictrum fendleri* var. *polycarpum*. Source: Flowersinmyyard, <https://commons.wikimedia.org/w/index.php?curid=68320295>. Found on Page 276
- Figure 243. *Elymus condensatus*. Source: Peggy A. Lopipero-Langmo, <https://www.flickr.com/photos/98699202@N03/10355498513>. Found on Page 276
- Figure 244. *Quercus lobata*. Source: King of Hearts, <https://commons.wikimedia.org/w/index.php?curid=75700289>. Found on Page 284
- Figure 245. *Platanus racemosa*. Source: Raffi Kojian, <http://www.gardenology.org>, <https://commons.wikimedia.org/w/index.php?curid=9705655>. Found on Page 284
- Figure 246. *Frangula californica* ssp. *californica*. Source: Krzysztof Ziarnik, Kenraiz, <https://commons.wikimedia.org/w/index.php?curid=54696941>. Found on Page 284
- Figure 247. *Eriophyllum confertiflorum*. Source: Björn S..., <https://www.flickr.com/photos/40948266@N04/43163438812>. Found on Page 284

Figure 248. *Sisyrinchium bellum*. Source: Franco Folini, <https://www.flickr.com/photos/livenature/4350730696>. Found on Page 284

Figure 249. *Eschscholzia californica*. Source: docentjoyce, <https://commons.wikimedia.org/w/index.php?curid=8495738>. Found on Page 284

Figure 250. *Vitis girdiana*. Source: Stickpen, <https://commons.wikimedia.org/wiki/File:Vitisgirdiana1.JPG>. Found on Page 284

Figure 251. *Stipa cernua*. Source: Kyle Nessen, <https://www.inaturalist.org/photos/38751036>. Found on Page 284

Figure 252. *Stipa pulchra*. Source: Matt Lavin, [https://www.flickr.com/photos/plant\\_diversity/35034340452](https://www.flickr.com/photos/plant_diversity/35034340452). Found on Page 284

Figure 253. *Juglans californica*. Source: Consultaplantas, <https://commons.wikimedia.org/w/index.php?curid=44978241>. Found on Page 288

Figure 254. *Sambucus nigra* ssp. *caerulea*. Source: Stan Shebs, <https://commons.wikimedia.org/w/index.php?curid=1953423>. Found on Page 288

Figure 255. *Heteromeles arbutifolia*. Source: Miguel Vieira, <https://commons.wikimedia.org/w/index.php?curid=19525268>. Found on Page 288

Figure 256. *Salvia leucophylla*. Source: John Rusk, [https://www.flickr.com/photos/john\\_d\\_rusk/9309081263](https://www.flickr.com/photos/john_d_rusk/9309081263). Found on Page 288

Figure 257. *Malacothamnus fasciculatus*. Source: Stan Shebs, <https://commons.wikimedia.org/w/index.php?curid=1113761>. Found on Page 288

Figure 258. *Asclepias fascicularis*. Source: Jim Morefield, <https://www.flickr.com/photos/127605180@N04/15966683860>. Found on Page 288

Figure 259. *Achillea millefolium* var. *californicum*. Source: Dcrjsr, <https://commons.wikimedia.org/w/index.php?curid=16059528>. Found on Page 288

Figure 260. *Calystegia macrostegia* ssp. *arida*. Source: OLIN, 2017. Found on Page 288

Figure 261. *Solidago californica*. Source: Stickpen, <https://commons.wikimedia.org/w/index.php?curid=8092464>. Found on Page 288

Figure 262. *Salix exigua*. Source: Thayne Tuason, [https://commons.wikimedia.org/wiki/File:Salix\\_exigua\\_var.\\_exigua\\_4.jpg](https://commons.wikimedia.org/wiki/File:Salix_exigua_var._exigua_4.jpg). Found on Page 294

Figure 263. *Baccharis salicifolia*. Source: Krzysztof Ziarnek, Kenraiz, <https://commons.wikimedia.org/w/index.php?curid=54913701>. Found on Page 294

Figure 264. *Cyperus eragrostis*. Source: Krzysztof Ziarnek, Kenraiz, [https://commons.wikimedia.org/wiki/Category:Cyperus\\_eragrostis#/media/File:Cyperus\\_eragrostis\\_kz03.jpg](https://commons.wikimedia.org/wiki/Category:Cyperus_eragrostis#/media/File:Cyperus_eragrostis_kz03.jpg). Found on Page 294

Figure 265. *Typha latifolia*. Source: R. A. Nonenmacher, [https://commons.wikimedia.org/wiki/File:Typha\\_latifolia\\_7642.jpg](https://commons.wikimedia.org/wiki/File:Typha_latifolia_7642.jpg). Found on Page 294

Figure 266. *Bolboschoenus maritimus*. Source: Stefan Lefnaer, [https://commons.wikimedia.org/wiki/File:Bolboschoenus\\_maritimus\\_s.\\_str.\\_sl5.jpg](https://commons.wikimedia.org/wiki/File:Bolboschoenus_maritimus_s._str._sl5.jpg). Found on Page 294

Figure 267. *Schoenoplectus californicus*. Source: Forest and Kim Starr, [https://upload.wikimedia.org/wikipedia/commons/2/2a/Burr\\_Marigold\\_Bidens\\_Laavis\\_%28237189541%29.jpeg](https://upload.wikimedia.org/wikipedia/commons/2/2a/Burr_Marigold_Bidens_Laavis_%28237189541%29.jpeg). Found on Page 294

Figure 268. *Bidens laevis*. Source: Suzanne Antonia, [https://commons.wikimedia.org/wiki/File:Burr\\_Marigold\\_Bidens\\_Laavis\\_\(237189541\).jpeg](https://commons.wikimedia.org/wiki/File:Burr_Marigold_Bidens_Laavis_(237189541).jpeg). Found on Page 294

Figure 269. *Sparganium eurycarpum*. Source: Tom Koerner, [https://commons.wikimedia.org/wiki/File:Bur-reed\\_\(Sparganium\\_eurycarpum\)\\_Sand\\_Lake\\_Wetland\\_Management\\_District\\_01\\_\(14385334072\).jpg#filelinks](https://commons.wikimedia.org/wiki/File:Bur-reed_(Sparganium_eurycarpum)_Sand_Lake_Wetland_Management_District_01_(14385334072).jpg#filelinks). Found on Page 294

Figure 270. *Artemisia douglasiana*. Source: Römert, <https://commons.wikimedia.org/w/index.php?curid=19802958>. Found on Page 294

Figure 271. *Elymus glaucus* ssp. *glaucus*. Source: Wild Bryde, <https://www.inaturalist.org/photos/38822555>. Found on Page 300

Figure 272. *Lotus scoparius* (*Acmispon glaber*). Source: glmory, <https://commons.wikimedia.org/w/index.php?curid=32092287>. Found on Page 300

Figure 273. *Isocoma menziesii* ssp. *vernonioides*. Source: Miguel Vieira, <https://commons.wikimedia.org/w/index.php?curid=9389145>. Found on Page 300

Figure 274. *Bromus carinatus*. Source: Matt Lavin, [https://www.flickr.com/photos/plant\\_diversity/3861052158](https://www.flickr.com/photos/plant_diversity/3861052158). Found on Page 300

Figure 275. *Deinandra fasciculata*. Source: Björn S., [https://commons.wikimedia.org/wiki/File:Clustered\\_Tarweed\\_-\\_Deinandra\\_fasciculata\\_\(41948547430\).jpg](https://commons.wikimedia.org/wiki/File:Clustered_Tarweed_-_Deinandra_fasciculata_(41948547430).jpg). Found on Page 300

Figure 276. *Stipa cernua*. Source: Kyle Nessen, <https://www.inaturalist.org/photos/38751036>. Found on Page 300

Figure 277. *Stipa lepidota*. Source: John Rusk, <https://commons.wikimedia.org/w/index.php?curid=59287600>. Found on Page 300

Figure 278. *Muhlenbergia rigens*. Source: Krzysztof Ziarnek, Kenraiz, <https://commons.wikimedia.org/w/index.php?curid=54450777>. Found on Page 300

Figure 279. *Koeleria macrantha*. Source: Matt Lavin, [https://commons.wikimedia.org/wiki/File:Koeleria\\_macrantha\\_\(3879657197\).jpg](https://commons.wikimedia.org/wiki/File:Koeleria_macrantha_(3879657197).jpg). Found on Page 300

Figure 280. *Parkinsonia florida*. Source: Stan Shebs, <https://commons.wikimedia.org/w/index.php?curid=344153>. Found on Page 306

Figure 281. *Quercus wislizeni*. Source: Krzysztof Ziarnek, Kenraiz, [https://commons.wikimedia.org/wiki/File:Quercus\\_wislizeni\\_kz3.jpg](https://commons.wikimedia.org/wiki/File:Quercus_wislizeni_kz3.jpg). Found on Page 306

Figure 282. *Atriplex canescens*. Source: Stan Shebs, <https://commons.wikimedia.org/w/index.php?curid=4269398>. Found on Page 306

Figure 283. *Calliandra eriophylla*. Source: Chris English, <https://commons.wikimedia.org/w/index.php?curid=56261079>. Found on Page 306

Figure 284. *Fallugia paradoxa*. Source: Stan Shebs, <https://commons.wikimedia.org/w/index.php?curid=3929255>. Found on Page 306

Figure 285. *Larrea tridentata*. Source: Andrey Zharkikh, <https://commons.wikimedia.org/w/index.php?curid=60781561>. Found on Page 306

Figure 286. *Encelia farinosa*. Source: Stan Shebs, <https://commons.wikimedia.org/w/index.php?curid=204952>. Found on Page 306

Figure 287. *Sphaeralcea ambigua*. Source: Stan Shebs, <https://commons.wikimedia.org/w/index.php?curid=8563714>. Found on Page 306

Figure 288. *Abutilon palmeri*. Source: Ken-ichi Ueda, <https://www.inaturalist.org/photos/27181425?size=large>. Found on Page 306

Figure 289. *Cercis occidentalis*. Source: Stan Shebs, [https://commons.wikimedia.org/wiki/File:Cercis\\_occidentalis\\_1.jpg](https://commons.wikimedia.org/wiki/File:Cercis_occidentalis_1.jpg). Found on Page 312

Figure 290. *Chilopsis linearis*. Source: Krzysztof Ziarnek, Kenraiz, <https://commons.wikimedia.org/w/index.php?curid=54448559>. Found on Page 312

Figure 291. *Chitalpa tashkentensis*. Source: Frau Siebenschläfer, <https://commons.wikimedia.org/w/index.php?curid=15746538>. Found on Page 312

Figure 292. *Hesperocyparis forbesii*. Source: Consultaplantas, [https://commons.wikimedia.org/wiki/File:Cupressus\\_forbesii\\_1c.JPG](https://commons.wikimedia.org/wiki/File:Cupressus_forbesii_1c.JPG). Found on Page 312

Figure 293. *Lyonothamnus floribundus* ssp. *asplenifolius*. Source: J Brew, <https://commons.wikimedia.org/w/index.php?curid=15394974>. Found on Page 312

Figure 294. *Pinus torreyana*. Source: Richard O. Barry, [https://en.m.wikipedia.org/wiki/File:Pinus\\_torreyana\\_at\\_State\\_Reserve.jpg](https://en.m.wikipedia.org/wiki/File:Pinus_torreyana_at_State_Reserve.jpg). Found on Page 312



- Figure 295. Quillaja saponaria. Source: Daderot, <https://commons.wikimedia.org/w/index.php?curid=37387713>. Found on Page 312
- Figure 296. Quercus douglasii. Source: Yath, [https://commons.wikimedia.org/wiki/File:Large\\_Blue\\_Oak.jpg](https://commons.wikimedia.org/wiki/File:Large_Blue_Oak.jpg). Found on Page 312
- Figure 297. Tipuana tipu. Source: Daniel Ventura, <https://commons.wikimedia.org/w/index.php?curid=2246165>. Found on Page 312
- Figure 298. Projects Along the LA River. A consistent cadence of XS, S, M, L, and XL projects occurs along the 51 miles of the LA River. Source: LA River Master Plan, 2020. Found on Page 324
- Figure 299. Chapter 6 of this document covers items related to facilities and amenities along the LA River. Source: LA River Master Plan, 2020. Found on Page 327
- Figure 300. Lewis MacAdams Riverfront Park is one example of an existing pavilion along the LA River at river mile 26. Source: LA Public Works, 2018. Found on Page 329
- Figure 301. Shade, Rest, and Gathering Pavilions all occur at a consistent cadence along the river. A base level of amenities are to be installed at a minimum of every half mile along each bank of the river. Source: OLIN, 2019. Found on Page 331
- Figure 302. Pavilion A, B, and C components range in size and programming from shade and drinking fountains to restrooms and community kitchens. Source: Gehry Partners, 2019. Found on Page 332
- Figure 303. The basic components of a Shade Pavilion include shade, seating, and drinking fountains. Various components are illustrated here and dimensions are shown as general guides, not exact requirements. Source: Gehry Partners, 2019. Found on Page 333
- Figure 304. The basic components of a Rest Pavilion include restrooms, bike racks, and a snack station. Dimensions are general guides and not exact requirements. Source: Gehry Partners, 2019. Found on Page 334
- Figure 305. Restrooms should consist of single occupancy stalls, preferably including both a storage room and a mother's room. Various components are illustrated here and dimensions are shown as general guides, not exact requirements. Source: Gehry Partners, 2019. Found on Page 335
- Figure 306. The basic components of a Gather Pavilion include a programed element such as a cafe or community center. Cafes can vary in size depending on the project site. Dimensions are general guides and not exact requirements. Source: Gehry Partners, 2019. Found on Page 336
- Figure 307. Locker rooms in Gather Pavilions may not be able to provide single use occupancy restrooms or locker stalls, although they are preferred if possible. Various components are illustrated here and dimensions are shown as general guides, not exact requirements. Source: Gehry Partners, 2019. Found on Page 337
- Figure 308. Gather Pavilions may include a bike repair and rental shop or a public safety station. Supporting facilities such as management offices or additional storage can also be included. Dimensions are general guides and not exact requirements. Source: Gehry Partners, 2019. Found on Page 338
- Figure 309. Gather Pavilions may include rooms that can be of general use to the community, such as a community kitchen or multipurpose room. Various components are illustrated here and dimensions are shown as general guides, not exact requirements. Source: Gehry Partners, 2019. Found on Page 339
- Figure 310. Pavilions can be configured in a variety of footprints ranging from compact linear to expanded depending on the project site. Source: Gehry Partners, 2019. Found on Page 341
- Figure 311. This example design of Shade Pavilion (Tier I) at river mile 14.7 demonstrates how trail users can be welcomed with environmental graphics, an accessible ramp entrance, and amenities such as bike racks and drinking fountains. Source: OLIN, 2019. Found on Page 342
- Figure 312. The plan of the Shade Pavilion (Tier I) example at river mile 14.7 shows how multiple points of access are provided to the LA River multiuse trail. Source: OLIN, 2019. Found on Page 343
- Figure 313. The Shade Pavilion (Tier I) can be configured in a variety of footprints from compact to expanded, depending on the project site and other constraints. Source: Gehry Partners, 2019. Found on Page 344
- Figure 314. These example plans show how the Shade Pavilion (Tier I) can be implemented in a variety of urban contexts along the LA River. Source: Gehry Partners, 2019. Found on Page 345
- Figure 315. The example design for a Rest Pavilion (Tier II) at river mile 50.9 welcomes users through pavement markings, a picnic area, and a local food vendor. Public restrooms are an important feature of Rest Pavilions. Source: OLIN, 2019. Found on Page 346
- Figure 316. The plan of the Rest Pavilion (Tier II) example at river mile 50.9 shows how access is provided to the LA River multiuse trail and how stormwater can be treated prior to entering the LA River. Source: OLIN, 2019. Found on Page 347
- Figure 317. The Rest Pavilion (Tier II) can be configured in a variety of footprints from compact to expanded, depending on the project site and other constraints. Source: Gehry Partners, 2019. Found on Page 348
- Figure 318. These example plans show how the Rest Pavilion (Tier II) can be implemented in a variety of urban contexts along the LA River. Source: Gehry Partners, 2019. Found on Page 349
- Figure 319. This example design for a Gathering Pavilion (Tier III) at river mile 28.4 includes a cafe overlooking the LA River. Gather Pavilions often include community programming that requires expanded facilities. Source: OLIN, 2019. Found on Page 350
- Figure 320. The plan of the Gathering Pavilion (Tier III) example at river mile 28.4 shows how multiple facilities can be incorporated onto a project site. Source: OLIN, 2019. Found on Page 351
- Figure 321. The Gathering Pavilion (Tier III) can be configured in a variety of footprints from compact to expanded, depending on the project site and other constraints. Source: Gehry Partners, 2019. Found on Page 352
- Figure 322. These example plans show how the Gathering Pavilion (Tier III) can be implemented in a variety of urban contexts along the LA River. Source: Gehry Partners, 2019. Found on Page 353
- Figure 323. LA River Site Furnishings should use RAL 9007 for silver metallic finishes and an RAL 5013 to match the environmental graphics and for overall consistency along the LA River. Source: OLIN, 2019. Found on Page 357
- Figure 324. A variety of site furnishings can be placed at pavilions, parks, or along the river trail. See the following pages for more details on each element. Source: OLIN, 2019. Found on Page 357
- Figure 325. Litter receptacles should have simple forms with flat tops and an opening protected from rain. Source: OLIN, 2019. Found on Page 358
- Figure 326. (Top) Bicycle racks should be placed to allow room for parking and maneuvering. Source: OLIN, 2019. Found on Page 359
- Figure 327. (Bottom) Bicycle racks should be individual loops and simple forms without ornamentation. Source: OLIN, 2019. Found on Page 359
- Figure 328. Bench forms should prioritize users' comfort and provide flexibility in use. Source: OLIN, 2019. Found on Page 360
- Figure 329. Drinking fountains should not have cupping or bowl shapes for hygiene and ease of cleaning. Source: OLIN, 2019. Found on Page 361
- Figure 330. (Top) Luminaires should have a modern, simple form without ornamentation. Source: OLIN, 2019. Found on Page 363



- Figure 331. (Left) Luminaires should be Dark Sky compliant and not have protruding features. Source: Torres Area Light, Landscape Forms, 2017. <https://www.landscapeforms.com/en-US/product/Pages/Torres-Area-Light.aspx>. Found on Page 363
- Figure 332. (Top Right) All finishes should be a solid metallic grey color matching RAL 9007. Source: RAL-Color 9007, Wikimedia Commons, 2007. [https://commons.wikimedia.org/wiki/File:RAL-Color\\_9007.gif](https://commons.wikimedia.org/wiki/File:RAL-Color_9007.gif). Found on Page 363
- Figure 333. (Bottom Right) Luminaires should occur at a regular cadence to illuminate the path. Source: Rama Area Light, Landscape Forms, 2008. <https://www.landscapeforms.com/en-US/product/Pages/Rama-Area-Light.aspx>. Found on Page 363
- Figure 334. Factors such as light color temperature should step down incrementally when transitioning from street lighting to sensitive habitat areas that are not lit. Qualified lighting designers, landscape architects, and ecologists should work to limit the amount of light fixtures, reduce color temperature, and eliminate light spillover on a project by project basis. Source: OLIN, 2019. Found on Page 364
- Figure 335. (Left) Call boxes should have an identifiable and visible top. When possible, call boxes should match the LARMP Blue, RAL 5013. Source: Blue Light Tower, CASE Emergency systems, 2019. <https://www.caseemergencysystems.com/products/blue-light-tower/>. Found on Page 365
- Figure 336. (Middle) Call boxes should be freestanding tall structures with push button calling. Source: Blue Light Tower, CASE Emergency systems, 2019. <https://www.caseemergencysystems.com/products/blue-light-tower/>. Found on Page 365
- Figure 337. (Left) See-saws are an example of an active play structure. Source: OLIN, 2019. Found on Page 366
- Figure 338. (Right) Swing sets come in many materials and forms that can be used in a play area, including tire swings. Source: [https://pxhere.com/en/photo/653563?utm\\_content=shareClip&utm\\_medium=referral&utm\\_source=pxhere](https://pxhere.com/en/photo/653563?utm_content=shareClip&utm_medium=referral&utm_source=pxhere). Found on Page 366
- Figure 339. (Left) Play surfacing should meet fall requirements of prevailing codes while not leaching materials that negatively impact water quality. Source: <https://www.pxfuel.com/en/free-photo-xzrxa>. Found on Page 367
- Figure 340. (Right) Tree stumps and other passive play equipment can create areas for quiet, non-active play. Source: rikkerst, 2009. <https://pixabay.com/photos/tree-stumps-tree-slices-v-66915/>. Found on Page 367
- Figure 341. Attendees listening to the Jessica Henson speak about the Master Plan at the Canoga Park community meeting at river mile 51. Source: OLIN, 2018. Found on Page 370
- Figure 342. Students at the LA River Master Plan Youth Summit move between worksessions to learn about the LA River. Source: OLIN, 2018. Found on Page 397
- Figure 343. Community members actively participating in the planning process at the Community Meeting in Studio City. Source: LA County Public Works, 2019. Found on Page 398
- Figure 344. Steering committee members listen and discuss Master Plan items at the 8th Steering Committee Meeting. Source: OLIN, 2019. Found on Page 399

# ACKNOWLEDGMENTS

This update to the LA River Master Plan, completed in 2022 was initiated by the LA County Board of Supervisors and led by LA County Public Works. The creation of the plan was informed by numerous departments within LA County as well as municipalities, organizations, and individuals that served on the Steering Committee and Subcommittees.

In addition to the named individuals on these pages, many people committed to the future of the LA River contributed significantly to the plan by sharing ideas, priorities, and goals for the river.

This Master Plan was made possible only through their rich contributions.

---

## LA COUNTY BOARD OF SUPERVISORS

**Supervisor Hilda L. Solis**  
First District

**Supervisor Holly J. Mitchell**  
Second District

**Supervisor Sheila Kuehl**  
Third District

**Supervisor Janice Hahn**  
Fourth District

**Supervisor Kathryn Barger**  
Fifth District

---

## LA COUNTY PUBLIC WORKS

Director Mark Pestrella  
Angela George-Moody  
Dan Lafferty  
Keith Lilley

Carolina Hernandez  
Ramy Gindi  
Genevieve Osmeña  
Christine Wartman  
Ernesto Rivera  
Seta Marjanian  
Mark Beltran  
Alynn Sun  
Donna Diaz  
Eber Navarrete

Armando D'Angelo  
Armando Nunez-Fausto  
David Gallagher  
Helen To  
Iraj Nasser  
James Bazinet  
Kenneth Chow  
Khai Chung  
Luis Garcia

Luis Perez  
Mateusz Suska  
Nayiri Vartanian  
Paul Shadmani  
Richard Shieh  
Ryan Ong  
Stella Quiroz  
Stephen Zurek  
Yvonne Taylor



Figure 342. Students at the LA River Master Plan Youth Summit move between worksessions to learn about the LA River. Source: OLIN, 2018.

## INTERNAL COUNTY TEAM

### BOARD OF SUPERVISORS FIRST DISTRICT

Waqas Rehman  
 Guadalupe Duran-Medina  
 Martin Reyes  
 Aydin Pasebani  
 Teresa Villegas

### BOARD OF SUPERVISORS SECOND DISTRICT

Laura Muraida  
 Jessalyn Waldron  
 Karly Katona  
 Carmen Gosey

### BOARD OF SUPERVISORS THIRD DISTRICT

Maria Chong-Castillo  
 Sophie Freeman  
 Tessa Charnofsky  
 Katy Yaroslavsky  
 Virdiana Velez

### BOARD OF SUPERVISORS FOURTH DISTRICT

Daritzza Gonzalez  
 Jocelyn Rivera-Olivas

### BOARD OF SUPERVISORS FIFTH DISTRICT

Anish Saraiya  
 Chris Perry  
 Edel Vizcarra

### PUBLIC WORKS

Keith Lilley  
 Carolina Hernandez

### CHIEF SUSTAINABILITY OFFICE

Gary Gero  
 Rita Kampalath

### CHIEF EXECUTIVE OFFICE

Vani Dandillaya  
 Julia Orozco

### DEPARTMENT OF ARTS AND CULTURE

Kristin Sakoda  
 Heather Rigby  
 Grace Ramirez Gaston  
 Iris Anna Regn  
 Pauline Kamiyama  
 Leticia Rhi Buckley  
 Mayen Alcantara

### DEPARTMENT OF PARKS AND RECREATION

Alina Bokde  
 Michelle O'Connor  
 Sheela Mathai  
 Clement Lau  
 John Diaz

### DEPARTMENT OF REGIONAL PLANNING

Gina Natoli  
 Patricia Hachiya  
 Jennifer Mongolo  
 Connie Chung  
 Ayala Scott

### NATURAL HISTORY MUSEUM OF LOS ANGELES COUNTY

Carol Bornstein  
 Lila Higgins

### HEALTH SERVICES

Whitney Lawrence



**Figure 343. Community members actively participating in the planning process at the Community Meeting in Studio City.**  
 Source: LA County Public Works, 2019.

## CONSULTANT TEAM

**Mark Hanna, Project Manager**

**PRIME, LEAD ENGINEER, AND WATER RESOURCES:  
 GEOSYNTEC CONSULTANTS**

Mark Hanna  
 Ken Susilo  
 Najwa Pitois  
 Al Preston  
 Joe Goldstein  
 Paul Senker  
 Daniel Lee  
 Nami Tanaka  
 Curtis Fang  
 Stephanie Tong  
 Yoshi Andersen  
 Mustafa Ghuneim  
 Randy Brandt  
 Lea Kane  
 Stacy Luell  
 Keith Hudson  
 Katy King

**FACILITATION:  
 KEARNS & WEST**

Joan Isaacson  
 Jack Hughes  
 Jenna Tourje  
 Taylor York

**WEB DESIGN:  
 MOSAIC**

**Jessica Henson, Project Manager**

**LANDSCAPE ARCHITECTURE,  
 URBAN DESIGN, AND PLANNING:  
 OLIN**

Laurie Olin  
 Richard Roark  
 Jessica Henson  
 Andrew Dobshinsky  
 Nate Wooten  
 Joanna Karaman  
 Rebecca Klein  
 AJ Sus  
 Claire Casstevens  
 Diana Jih  
 Kate Lawler  
 Michael Miller  
 Danielle Toronyi  
 Alexa Vaughn-Brainard  
 Sarah Swanseen  
 Evangeline Sheridan  
 Gabriela Arevalo  
 Jonathan Franklin  
 Derek Lazo  
 Ruochoen Wang  
 Andrea Binz  
 David Armbruster  
 Megan Hedges

**BRANDING:  
 72&SUNNY**

**AFFORDABLE HOUSING:  
 STREET LEVEL ADVISORS**  
 Rick Jacobus

**ARCHITECTURE AND  
 PLANNING:**

**GEHRY PARTNERS**  
 Frank Gehry  
 Tensho Takemori  
 Meaghan Lloyd  
 Anand Devarajan  
 Shuo Zhai  
 Dana McKinney

**ENGAGEMENT:  
 RIVER LA, DAKELUNA**

Kate Moulene  
 Ed Reyes  
 Angela Barranco  
 Lou Pieh  
 Jon Switalski  
 Natalie Gonzalez  
 Jason Foster  
 Miguel Luna  
 Bridgette Calderon

**WATER RESOURCES:  
 KRIS HELM**

**MEDIA RELATIONS:  
 ACTUM**

Glenn Gritzner  
 Abby McRae





**Figure 344. Steering committee members listen and discuss Master Plan items at the 8th Steering Committee Meeting.** Source: OLIN, 2019.

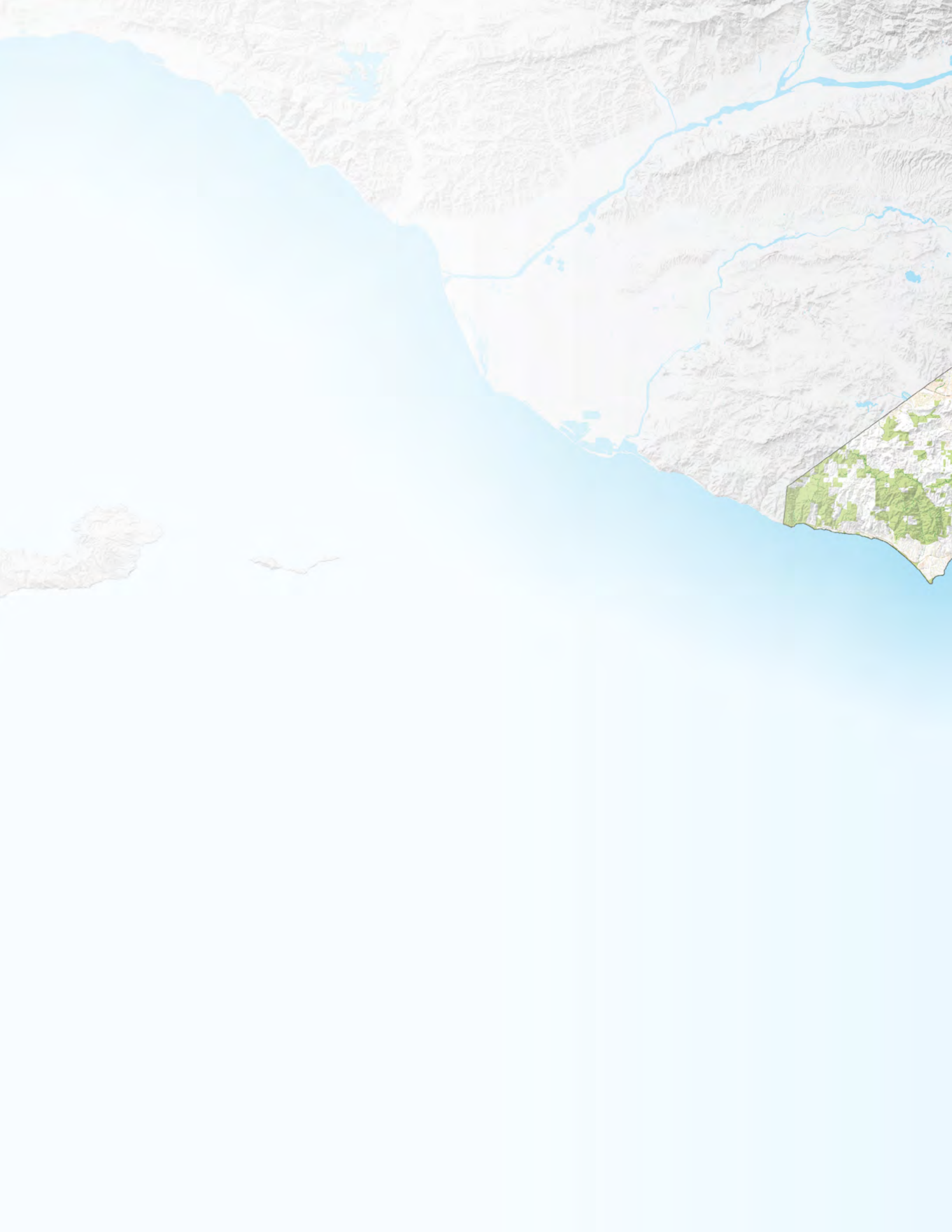
The LA River guidelines are an update of the 2004 Landscaping Guidelines and Plant Palettes. The original 1999 and 2004 guidelines were prepared by:

**Jill Benshoof  
Jan Sandgren  
Lacey Withers  
Verna Jigour**

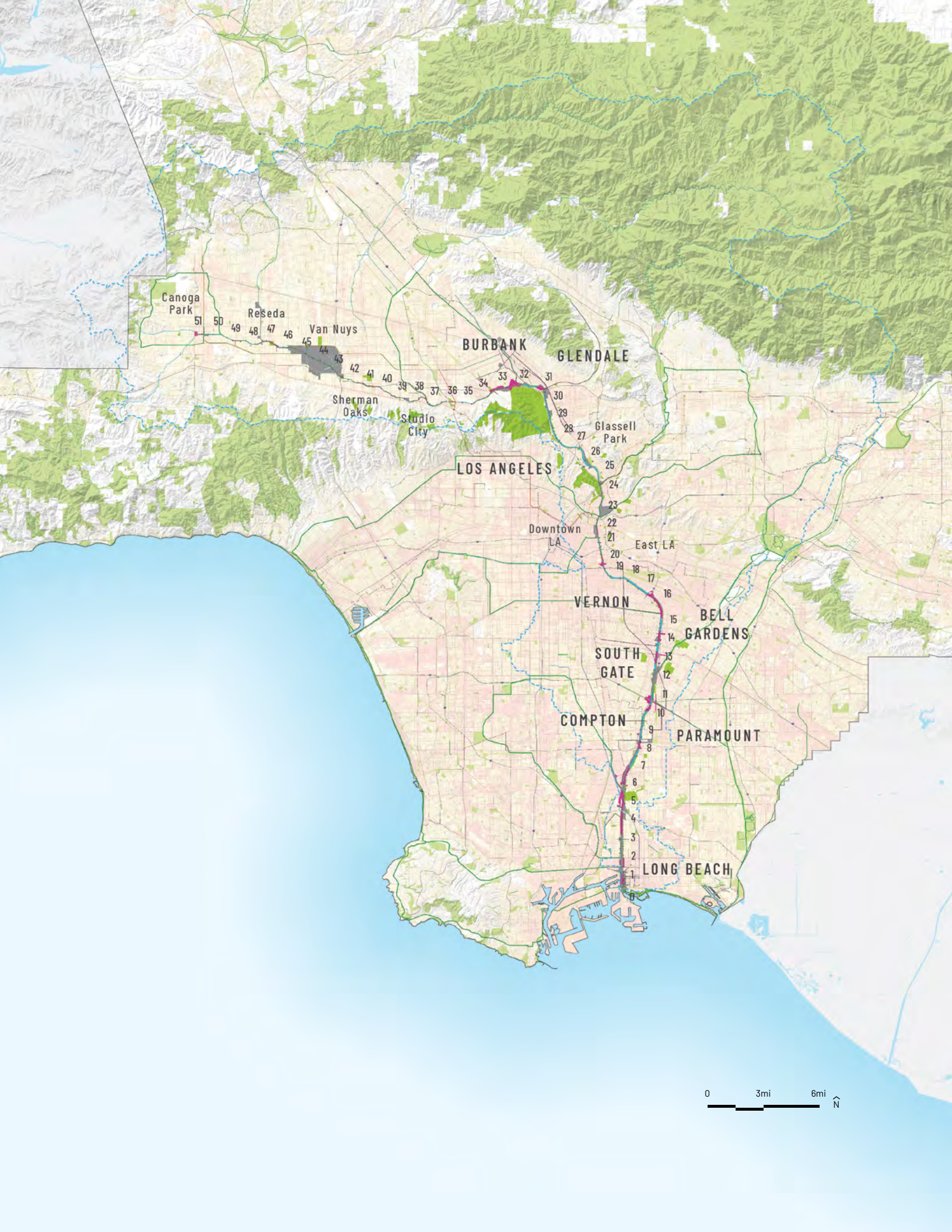
**Robert Perry  
Bart O'Brien  
Ellen Mackey  
Barbara Eisenstein**

**Maria Lopez  
Jason Casanova**









Canoga Park

Reseda

Van Nuys

BURBANK

GLENDALE

Sherman Oaks

Studio City

LOS ANGELES

Glassell Park

Downtown LA

East LA

VERNON

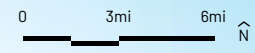
BELL GARDENS

SOUTH GATE

COMPTON

PARAMOUNT

LONG BEACH





Geosyntec<sup>▷</sup> **OLIN** Gehry Partners, LLP